

SIL2  
3 Year Warranty

# FCI FLT93® Series FlexSwitch™

Liquid Flow Switch ■ Air/Gas Flow Switch  
Liquid Level Switch ■ Interface Level Switch ■ Temperature Switch

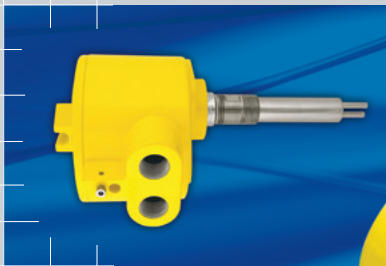
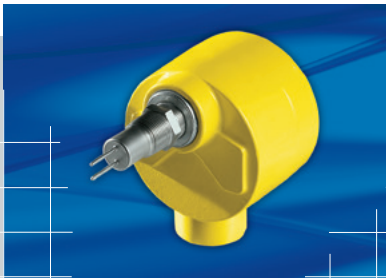

FCI FLT93 SERIES

- High / low pump flow detection
- Relief valve and flare gas flow or leakage detection
- HVAC flow monitoring
- Monitoring heat exchanger and filter fouling
- Drain line flow detection
- Seal leak and lubricant detection

- Wet/dry and sump seal detection
- Vapor recovery
- High / low level alarm and control
- Interface control in separation vessels
- High and low temperature alarm
- Analyzer flow detection

<input type="checkbox"/>	<input type="checkbox"/>
<input type="checkbox"/>	<input type="checkbox"/>



## FLT93® Series Features

- Dual trip points and relays
- SIL2 rated, ultra reliable
- 3 year warranty
- Ex agency approvals on complete instrument – FM, FMc, ATEX, IECEx, Inmetro, TR CU
- Small lines to largest diameter pipes
- Designed for rugged, industrial installations
- Apply in fluids to 850 °F [454 °C]
- No moving parts to foul, clog or maintain
- All welded elements
- Easy to install and set-up
- Highly sensitive and accurate
- Threaded, flanged, packing gland installation
- Integral or remote mounted electronics with choice of enclosures
- Field selectable AC and DC power

### The FLT93 Series with FlexSwitch Technology

FCI's FLT93 Series are the most popularly installed heavy duty thermal dispersion flow and level switches in the world. The reasons are simple; FLT93s were developed from more than 40 years of flow and level switch engineering and application experience to deliver the most reliable, repeatable, rugged and longest life industrial grade switch products found anywhere.

#### Flow Ranges for FLT93 S, FLT93 F, FLT93 C

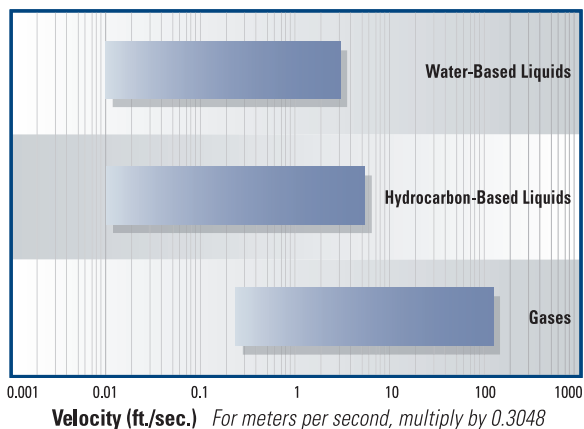

FLT93s are found in continuous operation in the most demanding and critical process and plant applications. You will find FLT93 the most preferred solution in oil and gas upstream and downstream applications; wastewater treatment; chemical operations; power plants, including nuclear power; food and beverage; refineries; mining; metals; manufacturing and more. Whether your application is for flow, level, flow + temperature or level + temperature, there is an FLT93 configuration to meet your needs.

### Standardization

This sensing and switching breakthrough is achieved in the FLT93 Series switches by combining a new, highly accurate, all-welded sensing element with an advanced, user-friendly FlexSwitch control circuit.

**Sensing Element.** Two standard sensing element configurations are available to meet your most demanding application requirements. The FLT93 S is designed for use in standard heavy industrial applications and in applications with high velocity liquid setpoint requirements; the FLT93 F is designed for fast response gas applications. Both sensing elements can be supplied in either standard (-40 °F to 350 °F [-40 °C to 177 °C]) or medium (-100 °F to 500 °F [-73 °C to 260 °C]) temperature configurations. The FLT93 S is also available in a high temperature (-100 °F to 850 °F [-73 °C to 454 °C]) configuration.

**Control Circuit.** One standardized, field-configurable FlexSwitch control circuit satisfies virtually any combination of application requirements. The FlexSwitch technology can be packaged to meet most integral or remote configurations.

### Precise Performance Accuracy

Leveraged from FCI's field-proven thermal dispersion experience, the unique sensor technology of the FLT93 Series switches, combined with FlexSwitch temperature compensation circuitry, introduces unparalleled performance capabilities:

- Exclusive flow accuracy as precise as  $\pm 2\%$  of the setpoint velocity over a  $\pm 50$  °F [ $\pm 28$  °C] temperature range; repeatability of  $\pm 0.5\%$  reading
- Level resolution of  $\pm 0.1$  inch [ $\pm 2.5$  mm]; repeatability of  $\pm 0.05$  inch [ $\pm 1.3$  mm]
- Standard temperature accuracy  $\pm 2.0$  °F [ $\pm 1$  °C]; repeatability  $\pm 1.0$  °F [ $\pm 0.6$  °C]; improved temperature accuracy is available with factory calibration

#### Typical Level and Interface Output Signals

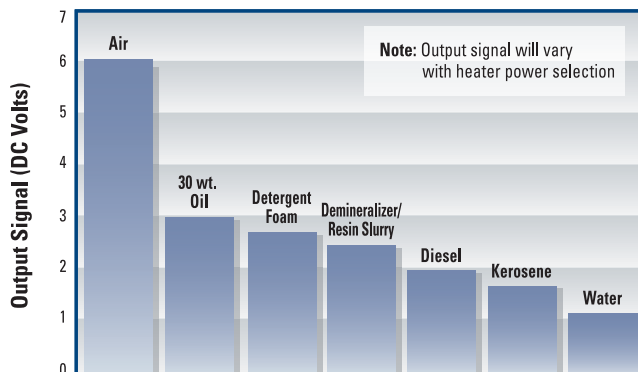

## Integrated Technologies / Advanced Circuitry

FCI's fail-safe, dual alarm (SPDT) control circuit provides the FLT93 Series switches with unmatched field flexibility and user-friendliness. The FlexSwitch control circuit also provides the exclusive advantage of one switch that offers the following field-selectable features.

- Dual, independent SPDT relays for these alarm combinations:
  - Flow rate and temperature
  - High flow and low flow
  - Point level and temperature
  - Flow rate and low liquid level
  - Three-phase level interface
  - Fail-safe flow, level, or temperature
- One DPDT relay for single alarm of flow rate, liquid level or temperature is optionally selectable

## Accuracy and Temperature Compensation

FLT93 Series switches are “precision temperature compensated” to ensure the accuracy of factory and field set alarms when installed in dynamic process applications. Accuracy combined with temperature compensation results in:

- Preventing false alarms or alarm failure
- Maximizing operator and process safety
- Having the option to set alarms within a narrow set point range

The following graphs illustrate how “temperature compensated” flow switches will not experience signal drift during temperature changes. Whereas a “non-temperature compensated” flow switch experiences signal drift (as indicated by the red arrow) causing alarm failure.

### Temperature Compensated Flow Curves

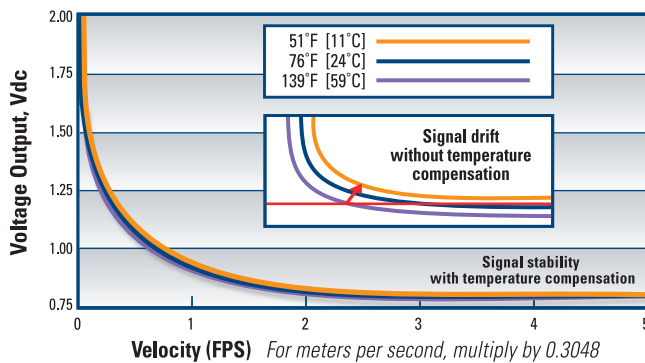

### Typical Liquid Flow Curves

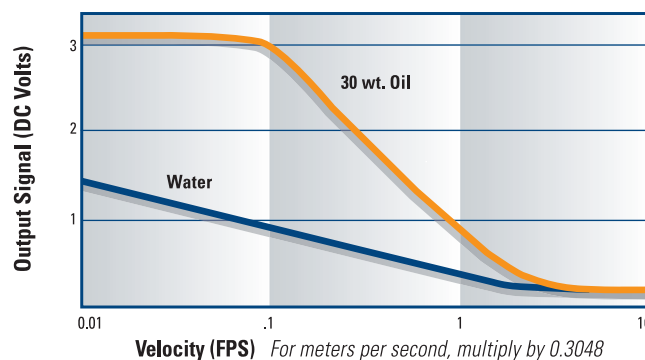

Shown with standard single-port style enclosure



Shown with optional dual-port style enclosure

## FLT93 S and FLT93 F Insertion FlexSwitch

### Sensing Element Feature Highlights

- No moving parts
- All welded design
- All 316L stainless steel, Hastelloy, or exotic materials

### FLT93 S

- Designed for heavy industrial environments
- High liquid flow rate sensitivity
- High temperature service
- Retractable packing glands
- All liquids and gases

### FLT93 F

- Air or gas applications
- Faster response
- Small process connection

### Control Circuit Feature Highlights

- Temperature compensation
- Analog output voltage for flow and temperature
- Calibration mode switch to simulate alarm setpoint
- Fail-safe setup
- Dual alarm, each with SPDT relay (DPDT optional)
- Field selected input power



## FLT93 C Sanitary Insertion FlexSwitch

Delivering the same field-tested performance and reliability as the FLT93 S and F, the FLT93 C is built with 316L stainless steel wetted parts polished to 20 Ra, and the process connection is a sanitary flange to meet the sanitary finish requirements in the food, beverage, or pharmaceutical processes.

The instrument's no moving parts design makes it ideal for monitoring the flow of syrups, fillings and other viscous media and product slurries. The FLT93 C is suitable for both clean-in-place and steam-in-place applications.

### Control Circuit Feature Highlights

Refer to FLT93 F and FLT93 S above

### Common Applications

- Pump protection
- Additive verification
- Gas / injection monitoring
- Syrup flow monitoring
- Low flow detection
- Level / interface

## Application Flexibility

Easy “field” or “factory preset” configurations. FlexSwitch circuit features are easily enabled and can be selected either in-situ or factory preset. Selections include the following:

Field Selectable Feature	Advantage/Benefit
<b>Input Power</b>	Select AC or DC; maximizes voltage source flexibility and emergency power operations
<b>Application/Heater Power Selection Jumpers</b>	Optimizes signal level or best configuration for changing application conditions
<b>Relay Configuration and Logic Jumpers</b>	Enables easy field selection of SPDT or DPDT configurations and relay energization modes
<b>Calibrate/Operate Mode</b>	Selects field verification, pre-check, calibration or general operation modes

## Maximized Instrument Life

Simple reconfiguration allows the instrument to be further utilized in new service applications or easily adjusted as specific application requirements change.

## Simple, Accurate, Field Set Alarms

Field calibrations and setpoint adjustments are easily performed. Voltage readings at critical setpoint values can easily be recorded for reference purposes or for optimized monitoring.

## Field Selectable Input Power

The FLT93 Series’ FlexSwitch circuit is field configurable for compatibility with the most common electrical power. Selection of 24 Vdc, 115 Vac or 230 Vac by simple jumper selection is a standard feature.

## Operation Verification and / or Pre-Check

Alarm setpoint and fail-safe verification is easily performed before installation or in-situ. The dual alarms are field-configured to fail-safe when used exclusively for flow rate, liquid level, or temperature alarm. Resulting from FCI’s historically proven durability, pre-check capability and fail-safe operation, operators will be protected from any unforeseen failure. This combination of features gives the FLT Series unrivaled reliability. Setpoints may be configured to provide failure information of sensing element assembly as well as control circuit electronic failure.

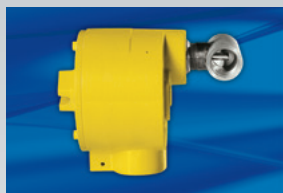
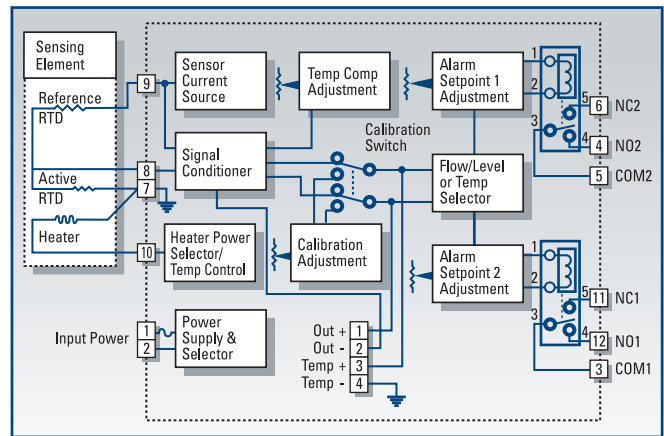

## FLT93 L In-Line FlexSwitch

### Sensing Element Feature Highlights

- Ideal for extremely low flow (down to .015 cc/sec)
- 316L stainless steel or Hastelloy C-276 wetted parts, all welded
- Process temperatures to 500 °F [260 °C]
- Process pressures to 3500 psig [241 bar(g)]
- Temperature compensation results in accurate and stable setpoints and output signals

### Control Circuit Feature Highlights

Refer to FLT93 F and FLT93 S on previous page

### Common Applications

- Chemical additive verification
- Coolant and lubrication seal leakage
- Lube flow detection
- Seal water flow
- Analyzer flow detector
- Air flow purge monitoring
- Spray nozzle monitoring

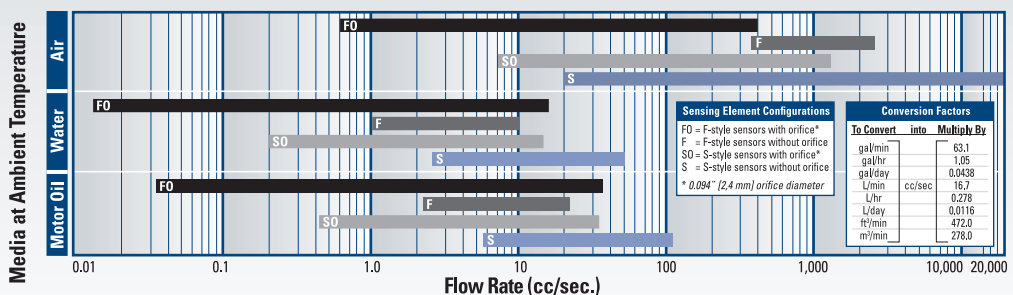

# FLT93 Series General Specifications

## Application

Flow rate and/or level/interface and temperature sensing in liquid, gas and slurry applications

## Sensing Elements

### Process Connection

#### Models S and F

3/4" male NPT standard; optional 1 inch BSP, 1" male NPT, 1/4" male NPT (FLT93 F only); flanges, spool pieces, sanitary fittings or retractable sensing element optional

#### Model L

1" male NPT or 3/4" female NPT, both ends with orifice; flanges optional

#### Model C

Sanitary flange

### Insertion Length

#### Models S and F

Available in standard lengths of 1.2" [30 mm], 2" [51 mm], 4" [102 mm], 6" [152 mm], 9" [229 mm], 12" [305 mm], 18" [457 mm] and custom-specified lengths

#### Model L

3.375" [86 mm] in-line body length

**Model C** Please see chart on outline dimensional

### Sensing Element

#### Models S and F

All wetted surfaces are 316L stainless steel with all-welded construction; Hastelloy C, Monel 400, electro-polished stainless steel and titanium (FLT93 S only) are optionally available; other spray coatings are available on special request (i.e., tantalum, chromium carbide)

#### Model L

All wetted surfaces are 316L stainless steel with all-welded construction; Hastelloy C, Monel 400 and titanium are optionally available

#### Model C

All wetted surfaces are 316L stainless steel with all-welded construction, selectable as mechanical polished or electro-polished to 20 Ra

### Operating Temperature

#### Sensing Element

##### All Models

Standard temperature configuration: -40 °F to 350 °F [-40 °C to 177 °C]; Medium temperature configuration: -100 °F to 500 °F [-73 °C to 260 °C]

##### Model S Only

High temperature configuration: -100 °F to 850 °F [-73 °C to 454 °C]

### Operating Pressure

FLT93 Model

S		F		L		C	
PSI	Bar(g)	PSI	Bar(g)	PSI	Bar(g)	PSI	Bar(g)

#### w/ NPT Process Connection

Standard Operating

-100 °F to 70 °F [-73 °C to 21 °C] max.

-100 °F to 500 °F [-73 °C to 260 °C]

501 °F to 850 °F [261 °C to 454 °C]

Proof/design at 70 °F [21 °C]

3500	241	3500	241	3500	241		
2350	162	2350	162	2350	162	1500	103
1450	100						
12450	858	10650	734	10650	734	6000	414

#### w/ Flanged Process Connection Per selected flange rating

#### w/ Compression Fitting Process Connection

Teflon ferrule to 200 °F [93 °C]

Metal ferrule to 500 °F [260 °C]

Proof/design at 70 °F [21 °C]

150	10						
250	17						
600	41						

Higher ratings available with special construction and test certification

## Electronics / Transmitter

### Relay Rating

Standard Dual SPDT or single DPDT; field configurable 6 amp resistive at 115 Vac, 240 Vac or 24 Vdc; gold-plated contacts

Optional Dual hermetically sealed relays; MIL-SPEC grade; 2A at 28 Vdc, 0.5 A at 115 Vac resistive

### Output Signal

Analog DC voltage related to flow or level/interface signal and proportional to temperature, standard

### Input Power

Universal AC/DC supply; input terminals and jumpers on circuit board select specific power

AC	108 V to 132 V	13 W, 100 mA maximum
AC	207 V to 253 V	14 W, 50 mA maximum
AC	18 V to 28 V	7 W, 230 mA maximum
DC	21 V to 30 V	7 W, 230 mA maximum

### Heater Power

Field or factory selected to optimize switching performance and rangeability for specific fluid service requirements

Typical Service	Sensing Element	Power (W)
Gas or Air	S-Style	0.75
	F-Style	0.25
Liquids	S-Style	3.0

The above typical service power selections are for reference only; depending on application requirements, surface temperature rating requirements, and rangeability expectations, alternate power selections may be recommended; other intermediate power selections can be made; consult installation manual for recommendations in your service

### Operating Temperature

-40 °F to 140 °F [-40 °C to 60 °C]

### Electrical Enclosure

Standard	Aluminum, polyester painted, single 1" NPT conduit port; NEMA 4X/IP67, Ex approved (see agency approvals); local enclosure Order Code C
Optional	Aluminum, polyester painted with dual 1/2" NPT conduit ports, NEMA 4X/IP67, Ex approved (see agency approvals); local enclosure Order Code H
Optional	Aluminum, polyester painted with dual M20 metric conduit ports, NEMA 4X/IP67, Ex approved (see agency approvals); local enclosure Order Code J
Optional	316 stainless steel, single 1" NPT conduit port; NEMA 4X/IP67, Ex approved (see agency approvals); local enclosure Order Code E

## For Flow Service

### Factory Calibrated Switch Point Accuracy

Any flow rate within the instrument flow range may be selected as a setpoint alarm; a factory-calibrated setpoint adjustment may be optimally preset with accuracy of  $\pm 2\%$  of setpoint velocity over an operating temperature range of  $\pm 50$  °F [ $\pm 28$  °C]

### Monitoring Accuracy

Based on a measured output voltage over the entire flow range, an operating temperature range of  $\pm 50$  °F [ $\pm 28$  °C], and an operating pressure range of  $\pm 100$  psig [ $\pm 7$  bar(g)]

**Liquids:**  $\pm 5\%$  reading or  $\pm 0.04$  SFPS [ $\pm 0.012$  NMPS], whichever is larger

**Gases:**  $\pm 5\%$  reading or  $\pm 2$  SFPS [ $\pm 0.61$  NMPS], whichever is larger

## For Flow Service

### Setpoint Range

#### Model S

##### Water-based Liquids

0.01 FPS to 0.5 FPS [0.003 MPS to 0.152 MPS] with 0.75 watt heater;

0.01 FPS to 3.0 FPS [0.003 MPS to 0.9 MPS] with 3.0 watt heater

##### Hydrocarbon-based Liquids

0.01 FPS to 1.0 FPS [0.003 MPS to 0.3 MPS] with 0.75 watt heater;

0.01 FPS to 5.0 FPS [0.003 MPS to 1.5 MPS] with 3.0 watt heater

[Specifications continued on next page]

# FLT93 Series General Specifications Cont'd

## For Flow Service

### Setpoint Range

#### Model S

##### Air/Gas

0.25 SFPS to 120 SFPS [0.08 NMPS to 37 NMPS] with 0.75 watt heater at standard conditions; 70 °F [21,1 °C], 14.7 psia [1,013 bar(g)]

##### Other Fluids

Contact the factory for approximate rangeability

#### Model F

##### Air/Gas

0.25 SFPS to 120 SFPS [0,08 NMPS to 37 NMPS] 0.75 watt heater at standard conditions; 70 °F [21,1 °C], 14.7 psig [1,013 bar(g)]

#### Model L

##### Water-based Liquids

0.015 cc/sec to 50 cc/sec

##### Hydrocarbon-based Liquids

0.033 cc/sec to 110 cc/sec

##### Air/Gas

0.6 cc/sec to 20,000 cc/sec

#### Model C

##### Water-based Liquids

0.01 FPS to 3.0 FPS [0,003 MPS to 0,9 MPS]

##### Syrup

To 5.0 FPS [0,0003 MPS to 1,5 MPS]

##### Air/Gas

0.25 SFPS to 120 SFPS [0,08 NMPS to 36,6 NMPS]

### Repeatability

±0.5% reading

## For Level / Interface Service

### Accuracy

**Model S:** ±0.25" [±6,4 mm]

**Model F:** ±0.1" [±2,5 mm]

### Repeatability

**Model S:** ±0.125" [±3,2 mm]

**Model F:** ±0.05" [±1,3 mm]

## For Temperature Service

### Accuracy

±2.0 °F [±1 °C] with field setpoint adjustment; monitoring accuracy ±3.5 °F [±2 °C] with standard curve fit output voltage operation across the selected instrument temperature range; higher accuracy available with factory calibrations

### Repeatability: ±1.0 °F [±0.6 °C]

The above accuracy is based on liquid or slurry service and in gas service with a minimum 1 SFPS [0,3 NMPS] velocity past the sensing element or with the heater deactivated for temperature sensing service only

## Factory Application-Specific Set-up and Setpoint Calibration

Standard instrument factory default setting, unless otherwise selected at order entry, will be as follows:

- 115 Vac input power for all FM Approved units; 230 Vac for all other agency approval units
- Dual SPDT alarms set for:
  - Alarm No. 1:** Preset for flow or level and to de-energize with decreasing conditions
  - Alarm No. 2:** Preset to de-energize for increasing temperature at 10 °F [5 °C] below the maximum instrument process temperature
- Heater power at 0.25 watt on **Model F** or 0.75 watt on **Model S**
- Calibration switch set at "operate"

Factory calibration including set-up for specific service, process fluid and alarm conditions optionally available; contact factory for fluid handling capabilities

## Agency Approvals



	FLT93 F	FLT93 S	FLT93 L	FLT93 C
FM	■	■	■	
FMc	■	■	■	
ATEX	■	■	■	■
IECEX	■	■	■	■
EAC, TR CU	■	■	■	■
Inmetro	■	■	■	■
CRN	■	■	■	■
CE / PED / LVD	■	■	■	■

### FM, FMc

XP, Class 1, Div. 1 Groups B,C,D, T3A or T4 Ta ≤60°C

DIP, Class II/III, Div. 1, Groups E,F,G, T3A or T4 Ta ≤60°C

Nonincendive for Class I, II and III, Division 2, Groups A,B,C,D,E,F, and G, T3A or T4 -40°C ≤Ta≤60°C; hazardous (classified) locations, indoors and outdoors Type 4X

### ATEX

Integral version II 2 G Ex db IIC T4...T2 Gb

II 2 D Ex tb IIIC T135°C...T300°C Db

Remote version

*Remote enclosure with electronics* II 2 G Ex db IIC T6 Gb

II 2 D Ex tb IIIC T85°C Db

*Local enclosure with sensor attached* II 2 G Ex db IIC T4...T1 Gb

II 2 D Ex tb IIIC T135°C...T345°C Db

### IECEX

Integral version Ex db IIC T4...T2 Gb

Ex tb IIIC T135°C...T300°C Db

Remote version

*Remote enclosure with electronics* Ex db IIC T6 Gb

Ex tb IIIC T85°C Db

*Local enclosure with sensor attached* Ex db IIC T4...T1 Gb

Ex tb IIIC T135°C...T345°C Db

- **Other Certifications:** CRN; RoHS Compliant; probe complies with Canadian Electrical code requirements of ANSI/ISA 12.27.01-2011 as a single seal device

- **MTBF:** 190 years

- **SIL:** SIL 2 compliant, safe failure fraction (SFF) 82% to 84%

## Approximate Shipping Weight and Warranty

**Integral:** 8 lb [3,6 kg]

**Remote:** 13 lb [5,9 kg]

*With stainless steel enclosure, add 4 lb [1,8 kg]*

**Warranty:** Three (3) years

# FLT93 S and FLT93 F FlexSwitch, Insertion

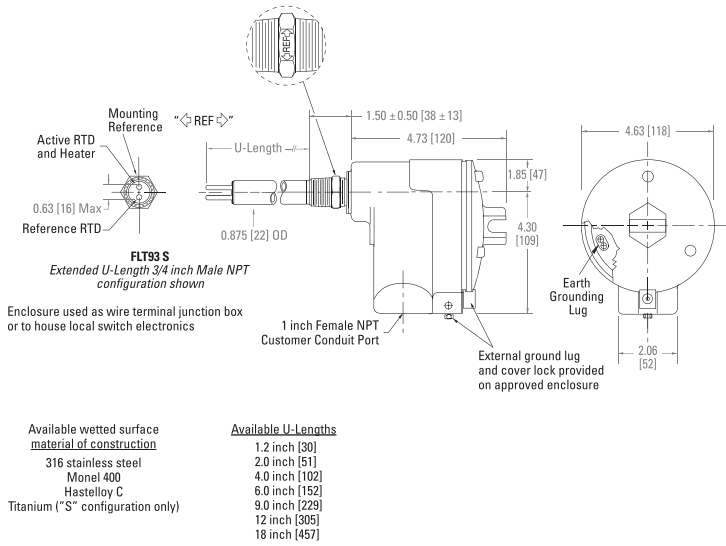

## Optional Dual-Conduit Port Enclosure

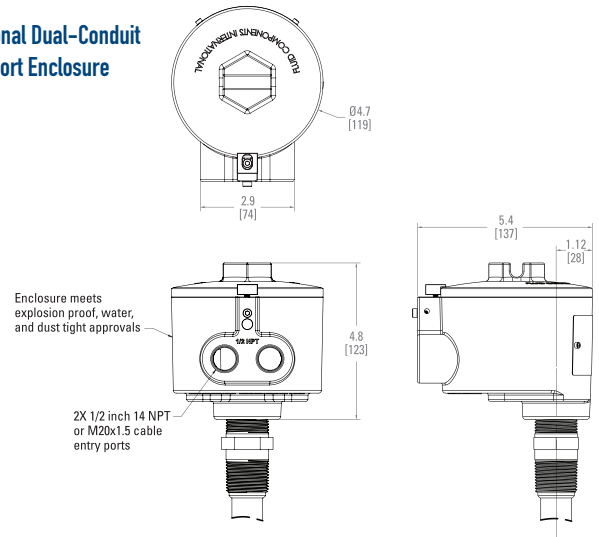

# FLT93 L FlexSwitch, In-line

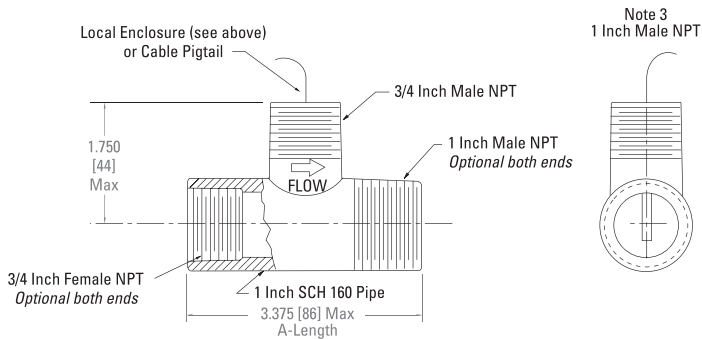

### Notes:

- For best performance, the sensing element should be installed into a vertical section of pipe. Liquids should flow up through the sensing element and gases should flow down through the sensing element.
- The time response of the F-style sensors is faster than the S-style sensors. However, the S-style sensors can withstand higher fluid forces (drag) than the F-style sensors.
- Refer to the FlexSwitch product brochure (Doc. No. 02MK011288) for additional information and complete specifications.
- Use the Model FLT93L Ordering Information Sheet (OIS Doc. No. 01SA011426) to configure the complete instrument part number.
- Sensing element A-length is 12.0 inches (305 mm) if flanges are specified for the process connection.

*Other end connections available.*

# FLT93 C FlexSwitch, Sanitary Insertion

A	B	C	D	E	F	U-Length
3/4	3/4	5.25	1.12	1.50	NA	1.17
1	1	4.75	1.06	2.12	1.50	1.25
1 1/2	1 1/2	5.50	1.37	2.12	1.75	1.93
2	2	7.00	1.62	2.12	2.00	1.93
2 1/2	2	5.68	1.87	2.12	2.25	1.93
3	2	6.18	2.12	2.12	2.50	2.75
4	2	8.12	2.12	2.12	3.00	2.75

*To convert to millimeters, multiply by 25.4*

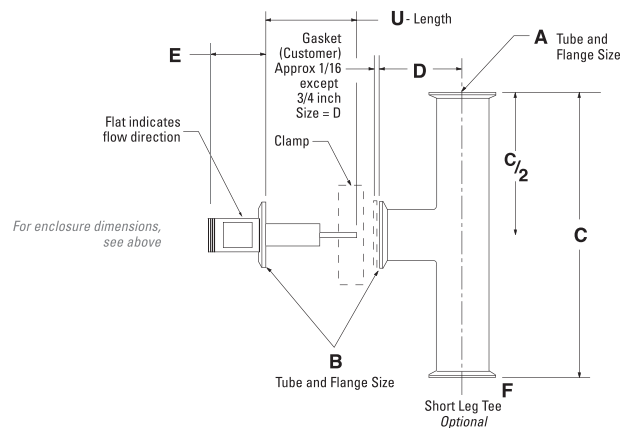

## Other FCI Flow and Level Switch Solutions



### ■ Economy Insertion Flow Switch/Monitor FS10i

Model FS10i is a compact all-digital insertion style flow switch designed for lighter-duty installations such as indoor or weather-protected outdoor areas. Outputs include both a 1A relay and 4-20 mA. They are Div. 2/Zone 2 approved and carry SIL 2 compliance rating.



### ■ Nuclear Safety Rated FLT93

Model FLT93 - Nuclear is a safety qualified version of the FLT93 for installations in nuclear power plant applications. Contact FCI for the latest version of Data Sheet #02MK011470, or visit the nuclear applications section of FCI's website to download literature.



### ■ Multi-Point Level FLT93 M

Model FLT93 M is a multi-point level detection instrument. Up to eight (8) sense points are mounted on a single immersible element. Contact FCI for more information.



### ■ Analyzer and Sampling System Flow Monitor FS10A

Model FS10A is a compact all-digital flow switch/monitor specifically designed for analyzer systems. Simple thread-in installation to standard tube tee or SP76 block. Contact FCI for the latest version of Data Sheet #02MK011533, or visit the flow switch products section of FCI's website to download literature.



Request a Quote

## FCI's World Class Calibration Ensures Installed Accuracy

All FCI products are tested and calibrated to rigorous standards to ensure you get the instrument that does the job you specified. To design and produce the highest quality flow instrumentation, FCI operates a world-class, fully NIST traceable flow calibration laboratory that is certified to meet such stringent standards as MIL-STD 45662A and ANSI/NCSL Z-540.

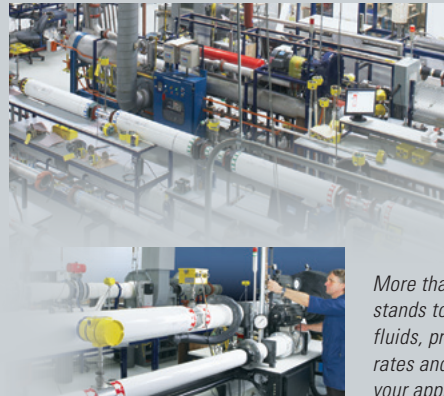

*More than 19 precision flow stands to match NIST traceable fluids, process conditions, flow rates and line sizes specified in your application.*

**FCI** FLUID COMPONENTS  
INTERNATIONAL LLC

Locally Represented By:

Visit FCI online at [www.FluidComponents.com](http://www.FluidComponents.com) | FCI is ISO 9001 and AS9100 Certified

#### FCI World Headquarters

1755 La Costa Meadows Drive | San Marcos, California 92078 USA

Phone: 760-744-6950 Toll Free (US): 800-854-1993

#### FCI Europe

Persephonestraat 3-01 | 5047 TT Tilburg, The Netherlands | Phone: 31-13-5159989

#### FCI Measurement and Control Technology (Beijing) Co., LTD

Room 107, Xianfeng Building II, No.7 Kaituo Road, Shangdi IT Industry Base, Haidian District | Beijing 100085, P. R. China

Phone: 86-10-82782381

