



PPC6000 SERIES FUEL AIR RATIO CONTROLLER

DESCRIPTION

The Fireeye PPC6000 is a state of the art stand-alone parallel positioning system for all types of liquid or gaseous fuel fired combustion systems. When combined with a Fireeye flame safeguard system such as the Fireeye BurnerLogix control, the PPC6000 offers the most compact and advanced parallel positioning system available. Four fuel profiles allow the PPC6000 to accommodate a variety of applications such as two fuels, with and without, the optional variable speed drive (VSD). With each profile having up to 24 points entered to assure a smooth “curve”, the microprocessor interpolates points between entered values and precisely positions fuel and air to within $\pm .1$ degree. This eliminates hysteresis for improved efficiency. The PPC6000 is capable of powering up to ten 24volt servomotors supplied from the integral transformer. All servomotors and displays operate on a secure CANbus communications protocol and can be “daisy chained” together for simplified wiring. Two independent PID control loops for temperature or pressure control provide precise, accurate control of firing rate for unmatched response to load changes. Four safety rated user definable digital inputs are standard and can be configured for functions such as lead lag, night setback, thermal shock warm up, etc. Digital inputs can also be configured as analog inputs via the optional programmable function blocks using Fireeye Abacus software. Built in lead lag sequencing for up to four boilers is included in every PPC6000. More elaborate lead lag schemes may be possible using the programmable function blocks.

Two variations of multifunction displays are available:

- NXTSD104 10.4” Color Touchscreen display with Ethernet, Modbus TCP/IP, 4 programmable relays and backup.
- NX610 display provides automatic storage of operating parameters and profiles for upload/download to the PPC6000. In addition, three line voltage fully programmable relays are mounted inside the display.



Other options include, two Variable speed drive (VSD) outputs via daughter board, Oxygen Trim using Fireye's proven heated zirconia oxide probe and optional interface, a wide variety of communications platforms such as Modbus is also available.

An optional internal freely programmable logic section of the PPC6000 means that external PLC's and expensive stand-alone sequencing controls may no longer be needed. Easy to program and protect, this new feature will make the PPC6000 suitable for many unique or unusual applications. Functions such as lead lag, sequencing, feedwater control and draft control are just some of the ways this feature can be used.

Optional ComFire software allows the user to view and control all aspects of the burner system, provides real time trending and logging, upload and download of profiles and options. The user can build custom screens or import actual photographs of the combustion equipment for animation.

Summary of PPC6000 Features

- State of the art surface mount technology
- Smallest footprint available: 7.0" x 4.5" x 2.5"
- Capable up to ten servomotors powered from the control
- Two PID loops for precise process control
- Simple four wire CANbus wiring reduces time and mistakes
- Optional VSD card provides two VSD's and one Analog output
- Re-transmittal of most data as 420mA output (requires NXDBVSD option)
- VSD encoder feedback available
- Standby lag boiler on water temp.
- Built in lead/lag sequencing for up to four boilers
- Fully programmable function block programming allows for custom applications such as draft control or feedwater control
- Two levels of displays: 12 Key Keypad with Backup, 10.4" Color Touchscreen
- Unparalleled worldwide support

Safety information



WARNING

The equipment described in this manual is capable of causing property damage, severe injury, or death. It is the responsibility of the owner or user to ensure that the equipment described herein is installed, operated and commissioned in compliance with the requirements of all national and local legislation, which may prevail.

When this equipment is fitted to an appliance due regard must also be given to the requirements of that appliance.

Before attempting to install, commission or operate this equipment all relevant sections of this document must be read and fully understood. If in doubt about any requirements consult Fireye.

Installation, commissioning or adjustment of this product MUST be carried out by suitably trained engineers or personnel qualified by training and experience.

After installation or modifications to the installation all functions of the equipment MUST be checked to ensure safe and reliable operation of the control.

The manufacturer of this equipment accepts no liability for any consequences resulting from inappropriate, negligent or incorrect installation, commissioning or adjustment of operating parameters of the equipment. Control panels **must not** be left uncovered while power is on. If it is essential to do so while rectifying faults only personnel qualified by training and experience should be involved.

The time any covers are off must be kept to a minimum and warning notices **must** be posted.

Before attempting any work on this equipment or any equipment controlled by or connected to this equipment, all related electrical supplies **must** be isolated.

Safety interlocks **must not** be removed or over-ridden. Any faults once detected **must** be corrected before the control is operated.

**CAUTION – SOME VERSIONS OF THIS EQUIPMENT CONTAIN
A LITHIUM BATTERY IN THE DISPLAY UNIT**

NOTE

The manufacturer of this equipment has a policy of continual product improvement and reserves the right to change the specification of the equipment and the contents of this manual without notice.



Table of contents

This manual describes the installation, commissioning, operation and maintenance of the PPC6000 series fuel air ratio controls. It may be used in conjunction with the following other manuals:

- NEX-1502 - ComFire combustion analysis tool user manual

Please read the safety information at the front of this manual before proceeding.

1	Technical specification	11
1.1	General	11
1.2	Servo-motor control – IMPORTANT: See Section 3.2	11
1.3	Digital outputs (<i>PPC6000</i>)	12
1.4	Alarm output (<i>PPC6000</i>)	12
1.5	Digital inputs (<i>PPC6000</i>)	13
1.6	Pressure/Temperature Input (<i>PPC6000</i>)	13
1.7	Communications interface (<i>PPC6000</i>)	13
1.8	Optional Oxygen Probe Interface Unit (<i>NXO2INT</i>) - <i>optional</i>	14
1.9	Optional Ambient Air Temperature Unit (<i>NXIATS</i>) - <i>optional</i>	14
1.10	Variable Speed Drive (VSD) Daughter Board (<i>NXDBVSD</i>) - <i>optional</i>	14
1.11	Fireeye NXC04, NXC12, NXC20, NXC20A, NXC40 Servo Motors	15
1.12	Fireeye NXO2INT Oxygen Probe Interface Unit (<i>optional</i>)	15
1.13	Fireeye NXIATS Ambient Air Temperature Sensor (<i>optional</i>)	16
1.14	Approvals	16
1.15	Parts List with Description	16
2	Installation	18
2.1	Mounting details for the PPC6000 control	19
2.2	Mounting details for the display module	20
2.3	Mounting details for optional Oxygen Probe Interface unit, NXO2INT	21
2.4	The oxygen trim option	22
2.4.1	Oxygen Probe description	22
2.4.2	Installation of oxygen probe	22
2.4.3	Mounting the oxygen probe	23
2.4.4	Mounting arrangements for Temperature and Steam pressure sensors	24
2.4.5	Boiler temperature sensors	24
2.4.6	Steam pressure sensors	25
2.5	Option link selection (<i>PPC6000</i>)	26
2.5.1	General (Access to jumper's and fuse's is gained by removing the back cover of the PPC6000)	26
2.5.2	Line supply voltage (LK1 - 4) (<i>PPC6000</i>)	26
2.5.3	SENS IN and SENS SUPP (boiler temp/pressure sensor) (<i>PPC6000</i>)	27
2.5.4	REMOTE SETPOINT (<i>PPC6000</i>)	27
2.5.5	RS485 serial communications termination resistor (<i>PPC6000</i>)	27
2.5.6	RS485 serial communications termination resistor (<i>daughter board</i>)	27
	IN	27
	IN	27
	IN	27
	IN	27
2.6	Wiring	29
2.6.1	General	29













2.6.2	Grounding cable screens	32
2.6.3	GROUND (EARTH) connection	32
2.6.4	Ground (earth) Connection (<i>display unit</i>)	33
2.6.5	Terminal Designation	33
2.6.6	LINE and NEUTRAL supply (<i>PPC6000</i>) PE1 & PE2	35
2.6.7	Safety Shutdown output (<i>PPC6000</i>)	36
2.6.8	Controlled Shutdown Relay Output (<i>PPC6000</i>)	36
2.6.9	Alarm Relay output – RELAY 4 (<i>on the PPC6000</i>)	36
2.6.10	Auxiliary Relay Outputs (<i>display</i>)	37
2.6.11	Fuel Select /Profile Select Input/Purge and Ignition Prove Outputs (<i>PPC6000</i>)	37
2.6.12	Low Voltage Digital Inputs (<i>PPC6000</i>) – <i>relevant Engineer's Keys EK1-EK4 (Sec. 6.6.2)</i>	38
2.6.13	Servo-motor and Display Connection (<i>PPC6000</i>)	38
2.6.14	Display Connection with PPC6000 and BurnerLogix YB110	39
2.6.15	Oxygen Probe Interface Connection (<i>PPC6000</i>)	40
2.6.16	Pressure/temperature sensor input (<i>PPC6000</i>)	40
2.6.17	Remote Setpoint (Analog Input 5) (<i>PPC6000</i>)	41
2.6.18	RS485 interface (<i>PPC6000</i>)	41
2.6.19	Variable Speed Drive Selection:	42
2.6.20	PPC6000 Variable Speed Drive Daughter Board P/N NXDBVSD	43
2.6.21	LIVE and NEUTRAL supply (<i>optional Oxygen Probe Interface unit</i>)	44
2.6.22	Oxygen probe connection (<i>optional Oxygen Probe Interface unit</i>), NX02INT	44
2.6.23	Inlet temperature sensor (<i>optional</i>)	46
2.7	Final checks	47





3	Servo-motor selection and calibration	48
3.1	Servo-motor selection	48
3.1.1	Motor requirements	48
3.2	IMPORTANT: Servo-motor direction warning	49
3.3	Locking the servo-motor to the valve shaft	50
3.4	Feedback potentiometer	50
3.5	Adjusting microswitch positions	51
3.6	Servomotor Replacement	52

4	Description of operation	53
4.1	The Display / Keypad	53
4.2	Start-up sequence	54
4.3	Non-volatile lockout	59
4.4	Modulation	59
4.4.1	Normal/Remote mode.	59
4.4.2	Local mode. (LOC 1, LOC 2)	59

5	Commissioning the control	60
5.1	General	60
5.2	Commissioning data	61
5.2.1	Option parameters	61
5.2.2	Setpoints	61
5.3	The Commissioning process	61
5.3.1	Navigation	61
5.4	Description of Touchscreen operation.	63
5.4.1	The Touchscreen	63
5.4.2	Touchscreen Power on.	63
5.4.3	The Operation Mode line and Status messages	63
5.4.4	Touchscreen Overview display.	65

5.4.5	Touchscreen Lockout Reset (Alarm Mute) Function.	66
5.4.6	Touchscreen LED Indication.	66
5.4.7	Touchscreen Fuel/Profile Select.	67
5.4.8	Touchscreen 'Control' screen.	68
5.4.9	Touchscreen 'Menu' button.	68
5.4.10	Touchscreen 'Burner Settings' button.	68
5.4.11	Touchscreen 'Fault/Event Log' button.	70
5.4.12	Touchscreen 'Screen Configuration' button.	70
5.4.13	Cleaning the Touchscreen	71
5.4.14	Touchscreen Commission mode.	72
5.5	Using option set mode	74
5.5.1	Option parameter list	74
	Option 00.1 - Site passcode (0 - 999) DEFAULT VALUE is 154. LV3	74
	Option 00.2 - Serial communications control address (0 - 15) LV3	74
	Option 00.3 - Reset hours run (0 - 1) LV3	75
	Option 00.4 - User program select (0 / 1) LV1	75
	Option 00.6 - <i>Reserved</i>	75
	Option 00.7 - Modbus device address (1 - 99) LV3	75
	Option 00.8 - Modbus communications speed (0 - 3) LV3	76
	Option 01.0 - Power Up Option (0 - 30) LV3	76
	Option 01.1 - Keyboard Auto/Manual enable (0 - 1) LV3 [Engineer's Key 33]	76
	Option 01.2 - Mute/Reset Input enable (0 - 2) LV3	76
	 Option 02.x - Drive Name LV3	77
	 Option 03.x - Drive Serial Number LV3	78
	 Option 04.x - Drive Usage Information LV3	78
	 Option 05.x - Drive Options LV3	79
	 Options 06.1-06.4 - Profile Naming LV3	80
	Options 07.x, 08.x- <i>RESERVED</i>	80
	Option 09.0 - Inverter control accuracy (0 / 1) LV3	80
	Option 09.1 - Inverter error tolerance (0 / 1) LV3	80
	Option 09.2 - Inverter closed loop gain (15 - 125%) LV3	81
	Option 09.3 - Inverter stop time (0 - 100 seconds) LV3	81
	Option 09.4 - Inverter acceleration time (0-100 seconds) (60 seconds max. recommended) LV3	81
	Option 09.6 - VSD2 Speed Encoder Scaler (255 - 999) LV3	82
	Option 09.7 - <i>Reserved</i>	82
	Option 09.8 - <i>Reserved</i>	82
	Option 14.1 - Limit Relay (0 - 8) LV3	83
	Option 14.2 - Oxygen and Flue Temperature Limit Relay (0 - 8) LV3	83
	 Option 15.0 - Modulation sensor input type (0 - 3) LV3	84
	Option 15.1 - Modulation input decimal places (0 to 2)	84
	 Option 15.2 - Modulation input zero value (-999 to +999 / -99.9 to +99.9 / -9.99 to +9.99) LV3	85
	 Option 15.3 - Modulation input span value (-999 to +999 / -99.9 to +99.9 / -9.99 to +9.99) LV3	85
	 Option 15.4 - Setpoint display units (0 - 3) LV3	85
	 Option 15.5 - Boiler high safety limit (0 - 999 / 0.0 - 99.9 / 0.00 - 9.99) LV3	85
	Option 15.6 - Modulation Time (0 - 120 seconds) LV3	85
	Option 15.7 - Bumpless Transfer (0 or 1) LV3	86
	Option 15.8 - Low before Off (0 or 1) LV3	86
	Option 15.9 - <i>reserved</i>	86
	Option 16.2 - Allow profile swap (0 to 16) LV3	87
	Option 18.1 to 18.4 - Low Voltage Fail-safe Alarm / Lockout Inputs (0 - 460) LV3	91



Option 19.1 to 19.4 – Fail-safe Alarm / Lockout Display Messages LV3	93
Option 20.0 – Set-point Select input (0 - 35) LV3	94
Option 20.1 – Boiler Shutdown input (0 - 35). LV3	95
Option 20.2 – Low Fire Hold input (0 - 35). LV3	95
Option 20.3 – Oxygen Trim Disable input (0 - 35). LV3	95
Option 20.4 – Ignition Wait input (0 - 35). LV3	96
Option 20.5 – Purge Hold input (0 - 35). LV3	96
Option 20.6 – Purge Time Start input (0 - 35). LV3	96
Option 20.7 – Analog Input 5 function (0 - 2). LV3	96
Option 20.8 – Digital Input - Lead Boiler Select (0 – 35) LV3	97
 Option 21.0 – Set-point 1 enable (0 - 1) LV1	97
 Option 21.1 – Set-point 1 control value (0 - 999 / 00.0 - 99.9 / 0.00 - 9.99) LV1	97
 Option 21.2 – Set-point 1 proportional band (0 - 999 / 00.0 - 99.9 / 0.00 - 9.99) LV197	97
Option 21.3 – Set-point 1 integral time (0 – 999 seconds) LV1	97
Option 21.4 – Set-point 1 derivative time (0 – 999 seconds) LV1	98
 Option 21.5 - Setpoint 1 control limit type (0 - 2) LV3	98
Option 21.6 - Setpoint 1 low limit control value (Cut In) (0 - 999 / 00.0 - 99.9 / 0.00 - 9.99) LV1	98
Option 21.7 - Setpoint 1 high limit control value (Cut Out) (0 - 999 / 00.0 - 99.9 / 0.00 - 9.99) LV198	98
Option 21.8 – Remote Setpoint 1 zero (4ma) value (0 - 999 / 00.0 - 99.9 / 0.00 - 9.99) LV1	98
Option 21.9 – Remote Setpoint 1 span (20mA) value (0 - 999 / 00.0 - 99.9 / 0.00 - 9.99) LV1	98
Option 22.0 – PID (set-point) 2 enable (0 - 1) LV1	98
Option 22.1 – Set-point 2 control value (0 - 999 / 00.0 - 99.9 / 0.00 - 9.99) LV1	99
Option 22.2 – Set-point 2 proportional band (0 - 999 / 00.0 - 99.9 / 0.00 - 9.99) LV1	99
Option 22.3 – Set-point 2 integral term (0 – 999 seconds) LV1	99
Option 22.4 – Set-point 2 derivative term (0 - 100) LV1	99
Option 22.5 - Setpoint 2 control limit type (0 - 2) LV3	99
Option 22.6 - Setpoint 2 low limit control value (0 - 999 / 00.0 - 99.9 / 0.00 - 9.99) LV1	100
Option 22.7 - Setpoint 2 high limit control value (0 - 999 / 00.0 - 99.9 / 0.00 - 9.99) LV1	100
Option 22.8 – Maximum modulation rate	100
Option 22.9 – <i>Reserved</i>	100
Option 23.0 – Warming Enable (0 or 1) LV1	100
Option 23.1 – Warming Limit (0 - 999 / 00.0 - 99.9 / 0.00 - 9.99) LV1	100
Option 23.2 – Warming Time (0 to 999 minutes) LV1	100
Options 24.x – Sequencing	101
Option 24.0 Sequence Slaves (number of boilers) (0-3) LV1	102
Option 24.1 -24.3 Priority Number(s) LV1	102
Option 24.4 – Lead OFF Time LV1	103
Option 24.5 – Lead (master) Boiler Select Method LV1	103
Option 24.6 – lag (slave) On Rate (0-100%) LV1	104
Option 24.7 – lag (slave) On Delay (0-999 minutes) LV1	104
Option 24.8 – lag (slave) Off Rate (0-100%) LV3	104
Option 24.9 – lag (slave) Off Delay (0-999 minutes) LV3	104
Option 25.0 – Banking based on temperature / water temperature standby for steam boiler LV3104	104
Option 25.1 – Water temperature zero value LV3	105
Option 25.2 – Water temperature span value LV3	105
Option 25.3 – Water temperature cut-in LV1	105
Option 25.4 – Water temperature cut-out LV1	105
Option 25.5 – Temperature based warming limit LV1	105
Option 25.6 – Lag wait time LV1	105
Option 28.0 – Analog Input decimals (0-2) LV3	105
Option 28.1 – Analog Input 1 zero (0-999) LV3	105
Option 28.2 – Analog Input 1 span (0-999) LV3	105
Option 28.3 – Analog Input 2 decimals (0-2) LV3	105
Option 28.4 – Analog Input 2 zero (0-999) LV3	105
Option 28.5 – Analog Input 2 span (0-999) LV3	105



Option 28.6 – Analog Input 3 decimals (0-2) LV3	105
Option 28.7 – Analog Input 3 zero (0-999) LV3	106
Option 28.8 – Analog Input 3 span (0-999) LV3	106
Option 29.0 – 4-20mA Output 1 function if not VSD LV3	106
Option 29.1 – Output1 zero value (4mA output) LV3	106
Option 29.2 – Output1 span value (20mA output) LV3	106
Option 29.3 – 4-20mA Output 2 function if not VSD LV3	107
Option 29.4 – Output2 zero value (4mA output) LV3	107
Option 29.5 – Output2 span value (20mA output) LV3	107
Option 29.6 – 4-20mA Output 3 function if not VSD LV3	107
Option 29.7 – Output3 zero value (4mA output) LV3	107
Option 29.8 – Output3 span value (20mA output) LV3	107
Option 30.0 – Oxygen probe interface serial number LV3	109
Option 30.1 - Oxygen probe calibration offset value (0 – 999) LV3	109
Option 30.2 - Oxygen probe calibration gain value (0 – 999) LV3	110
Option 30.4 – Flue and inlet sensor temperature units (0 – 1) LV3	110
Option 30.5 - Oxygen input function (0/1) LV3	110
Option 30.6 - Oxygen probe calibrate enable (0 – 2) LV3	110
Option 30.7 - Boiler transport delay (5 – 60 seconds) LV3	111
Option 30.8 - Reset oxygen trim profile (0/1) LV3	111
Option 30.9 – Automatic trim commissioning (0 / 1) LV3	111
Options 31.1 to 31.4 - Trim Type for profiles 1 to 4 (0 to 2) LV3	113
Option 32.0 - Trim limit default (0/1) LV3	114
Options 33.1 to 33.4 - Trim integral gain (Default 10%) LV3	114
Option 34.0 - Trim proportional gain (0/1) LV3	115
Options 34.1 to 34.4 - Trim proportional gain (0.0 – 99.9%) LV3	115
Option 34.5 - Calculating and entering the flow values manually LV3	115
Option 35.0 – Inlet temperature sensor serial number LV3	118
Options 35.5 to 35.8-Calorific values of fuels/profiles 1 to 4 respectively (0.0 – 99.9) LV3	118
Option 35.9 - Boiler radiated heat loss (0.0 – 9.9%) LV3	119
Option 36.0 - Flue temperature alarm select (0/1) LV3	119
Options 36.1 to 36.4 - Flue temperature low alarm values (0 – 999) LV3	119
Option 38.0 - Oxygen alarm select (0 – 2) LV3	120
Options 38.1 to 38.4 - Oxygen low alarm values at low fire (0.0 – 99.9%) LV3	120
Options 39.1 to 39.4 - Oxygen low alarm values at high fire (0.0 – 99.9%) LV3	120
Options 40.1 to 40.4 - Oxygen high alarm values at low fire (0.0 – 99.9%) LV3	120
Options 41.1 to 41.4 - Oxygen high alarm values at high fire (0.0 – 99.9%) LV3	120
Option 42.0 – Second Oxygen probe interface serial number LV3	121
Option 42.1 – Second Oxygen probe calibration offset value (0 – 999) LV3	121
Option 42.2 – Second Oxygen probe calibration gain value (0 – 999) LV3	121
Option 42.3 – Second Oxygen probe calibrate enable (0 – 2) LV3	122
Option 42.4 – Max oxygen variation (0 – 9.9 %) LV3	122
Option 42.5 – Max flue temp variation (0 to 999 °C) LV3	123
Option 42.7 – Air pressure monitoring* – input number LV3	123
Option 42.8 – Air pressure monitoring* – Span LV3	123
Option 42.9 – Air pressure monitoring* – max error LV3	123
Option 43.0 – Water level / expansion unit** LV3 - <i>Reserved</i>	123
Option 43.1 – Water level / expansion unit** LV3 - <i>Reserved</i>	123
Option 44.0 - Set real time clock (0/1) LV1	123
Option 44.1 – Set Year (00 – 99) LV1	123
Option 44.2 – Set Month (1 – 12) LV1	123
Option 44.3 – Set Day of Month (1 – 31) LV1	123
Option 44.4 – Set Day of Week (1 - 7) LV1	124
Option 44.5 – Set Hours (0 - 23) LV1	124
Option 44.6 – Set Minutes (0 - 59) LV1	124
Option 44.7 – Set Seconds (0 - 59) LV1	124



Option 44.9 – Reset Fault Log (0 - 1) LV3	124
Option 45.0 - Erase / Restore enable (0 - 1) LV3	124
Option 45.1 - Erase command (0 - 5) LV3	125
Option 45.2 - Restore command (0 - 999) LV3	125
5.6 Commission ratio mode	126
5.6.1 Description	126
5.6.2 Using commission ratio mode	126
5.6.3 Leaving commission ratio mode	128
5.7 Adjust ratio mode	128
5.7.1 Description	128
5.7.2 Entering adjust ratio mode	128
5.7.3 Using adjust ratio mode	129
5.7.4 Leaving adjust ratio mode	130
5.8 Interrogating the software issue	130

6 Faults and fault finding	131
6.1 The fault display	131
6.2 What to do when a fault occurs	131
6.3 Non-volatile lockout	132
6.4 Fault subsets	132
6.5 Fault listing	132
6.6 The engineer's key	139
6.6.1 Fault history	140
6.6.2 Engineer's key parameter list	140
6.7 Troubleshooting	150
6.7.1 Display / General	150
6.7.2 Startup	151
6.7.3 Commissioning	151
6.7.4 Modulation	152
6.7.5 Inverters	153
6.8 YB110/TSD104 Fault Messages	155

7 Inverter (variable speed) drives	157
7.1 System configuration	157
7.2 Description of control method	158
7.3 Setting up the inverter for use with the PPC6000 series	158
7.4 Setting up the PPC6000 series for use with a inverter drive	159

8 The oxygen trim option	160
8.1 Oxygen Pro probe description	160
8.1.1 Installation of oxygen probe	160
8.1.2 Mounting the oxygen probe	160

9 Appendix	163
9.1 Calibrating and servicing the oxygen probe	163
9.1.1 Probe calibration	163
9.1.2 Oxygen Probe Filter Testing	164
9.1.3 Removing the oxygen probe from the flue	164
9.1.4 Filter replacement	165
9.1.5 Probe mounted flue thermocouple replacement.	165
9.2 Troubleshooting inverter problems	167
9.3 PID Tutorial	168



9.4	Combustion Profile Setup Guideline	169
9.5	Fireye PPC6000 Efficiency Calculations	170
9.6	Typical Wiring Diagrams	172
9.7	Operator's Guide	179
9.7.1	Introduction	179
9.7.2	General	179
9.7.3	Password	179
9.7.4	Adjusting Cut IN and Cut OUT	180
9.7.5	Manual Modulation	181
9.7.6	Resetting the Control	181
9.7.7	Fault and Fault Finding	182
9.7.8	Fault subsets	182
9.7.9	Fault listing	183
9.7.10	PID Tutorial	183
9.7.11	The startup / shutdown stages are as follows:	184
9.7.12	Non-volatile lockout	187
9.8	Fireye Nexus Combustion Curve	188

10	Function Block Programming Details	189
	Introduction to Fireye's Abacus Programming Software	189
1.1.	Introduction	189
1.4.	The schematic toolbar	193
1.5.	Place Function blocks	194
1.6.	Moving and editing the link lines	194

11	Circuit board connections	196
11.1	Inlet Air Temperature Sensor (Optional)	196
11.2	PPC6000 Variable Speed Drive Daughter Board P/N NXDBVSD	197
11.3	Oxygen probe connection (optional Oxygen Probe Interface unit)	198
11.4	PPC6000	199



1 Technical specification

1.1 General

Supply voltage	120/230Vac +10% - 15%
Power consumption	Approx. 60VA
Supply frequency	50/60 Hz \pm 5%
Ambient temperature range	0 to 60°C (32 to 140°F)
Control unit protection category	IP20. The control must be situated in a clean environment according to EN6730-1. Indoor: Control must be mounted in an NEMA1 (IP40) enclosure Outdoor: Control must be mounted in an NEMA3 (IP54) enclosure
Unit dimensions	Control unit 176 x 115 x 92mm (6.93 x 4.53 x 3.62 in) deep Display 132 x 132 x 36mm (5.20 x 5.20 x 1.42 in) deep
Weight	Control unit 1.55kg (3.42 lbs) Display 0.90Kg (1.98 lbs)
Type of display	2 lines x 20 characters, vacuum fluorescent display with membrane keypad.

1.2 Servo-motor control – IMPORTANT: See Section 3.2

Type	CANbus
Maximum (total) number of servo-motors	10 (see section 3 regarding servo-motors)
Maximum number of fuel profiles	4
Max. number of setpoints per profile	24 including close, purge and ignition
Positioning accuracy	\pm 0.1°
Response time to positioning error	15s for \pm 1.0°, 1s for \pm 5.0°
Number of fuel motors	Not Limited by profile (e.g. 2 or 3 fuel motors). All non-monotonic.
Number of air (non fuel) motors	Not Limited by profile (e.g. 2 or 3 fuel motors). All non-monotonic.
	NOTE: Number of servomotors is limited in all profiles by VA rating. See Section 3.1



Interface to PPC6000	CANbus															
Speed	30 seconds for 90 degrees.															
Microswitches	Open & close positions															
Torque	<table border="1"> <thead> <tr> <th></th> <th>Driving</th> <th>Holding</th> </tr> </thead> <tbody> <tr> <td>NXC04</td> <td>4Nm/ 3 ft/lb</td> <td>2Nm</td> </tr> <tr> <td>NXC12</td> <td>12Nm/ 9 ft/lb</td> <td>18Nm</td> </tr> <tr> <td>NXC20, NXC20A</td> <td>20Nm/ 14.7 ft/lb</td> <td>18Nm</td> </tr> <tr> <td>NXC40</td> <td>40Nm/ 29 ft/lb</td> <td>20Nm</td> </tr> </tbody> </table>		Driving	Holding	NXC04	4Nm/ 3 ft/lb	2Nm	NXC12	12Nm/ 9 ft/lb	18Nm	NXC20, NXC20A	20Nm/ 14.7 ft/lb	18Nm	NXC40	40Nm/ 29 ft/lb	20Nm
	Driving	Holding														
NXC04	4Nm/ 3 ft/lb	2Nm														
NXC12	12Nm/ 9 ft/lb	18Nm														
NXC20, NXC20A	20Nm/ 14.7 ft/lb	18Nm														
NXC40	40Nm/ 29 ft/lb	20Nm														
Voltage:	24-30Vac supplied from control only															
<u>VA rating / Temperature</u>	<table> <tr> <td>NXC04 – 3VA</td> <td>NXC04 = 0°C – 60°C</td> </tr> <tr> <td>NXC12 = 5VA</td> <td>NXC12 = 0°C – 60°C</td> </tr> <tr> <td>NXC20 = 10VA</td> <td>NXC20 = 0°C – 60°C</td> </tr> <tr> <td>NXC20A = 10VA</td> <td>NXC20A = -20°C – 60°C</td> </tr> <tr> <td>NXC40 = 18VA</td> <td>NXC40 = -20°C – 60°C</td> </tr> </table>	NXC04 – 3VA	NXC04 = 0°C – 60°C	NXC12 = 5VA	NXC12 = 0°C – 60°C	NXC20 = 10VA	NXC20 = 0°C – 60°C	NXC20A = 10VA	NXC20A = -20°C – 60°C	NXC40 = 18VA	NXC40 = -20°C – 60°C					
NXC04 – 3VA	NXC04 = 0°C – 60°C															
NXC12 = 5VA	NXC12 = 0°C – 60°C															
NXC20 = 10VA	NXC20 = 0°C – 60°C															
NXC20A = 10VA	NXC20A = -20°C – 60°C															
NXC40 = 18VA	NXC40 = -20°C – 60°C															
Protection Category	<p>NXC04 = IP40, NEMA 1 NXC12, NXC20, NXC20A = IP54, NEMA 3S NXC40 = IP65, NEMA 4</p>															
Typical accuracy	+/-0.1°															
Accuracy (as specified by EN12067)	+/-0.5°															

1.3 Digital outputs (PPC6000)

Controlled Shutdown, Safety Shutdown	
Type	On-off relay, de-energize for off.
Minimum current	200mA rms
Maximum current (per output)	8A rms
Maximum voltage	250Vac rms

1.4 Alarm output (PPC6000)

Alarm	
Type	On-off relay, de-energize for off.
Minimum current	200mA rms
Maximum current (per output)	4A rms
Maximum voltage	250Vac rms



1.5 Digital inputs (PPC6000)

Low Voltage digital inputs 1 to 4, HIGH input, AUTO input.	Digital, Switching 0V to 5V pulsed. Feed must be taken from the correct terminal as indicated in this manual. Inputs 1-4 configurable for 4-20Ma. Via function block programming. Less than 25mA $\pm 10V$ absolute maximum
Profile Select High voltage inputs	Digital, 0V for off, 90-264Vac for on.

1.6 Pressure/Temperature Input (PPC6000)

0-5V Maximum current Maximum voltage Input accuracy (typical) Input accuracy (as specified by EN12067)	Less than 2mA 0 to 5.0 volts maximum. $\pm 0.1\%$ $\pm 0.3\%$
4-20mA Maximum current Burden (load) resistor Input accuracy (typical) Input accuracy (as specified by EN12067)	2 wire loop or ext. powered 0 to 25mA maximum 220 Ohm nominal $\pm 1.0\%$ $\pm 1.1\%$

1.7 Communications interface (PPC6000)

2-wire RS485 plus ground, with termination resistor selected using a link. See Section 2.5.5.

An isolated 2-wire RS485 interface is available as an option. See Section 2.5.6.

See MOD-6101 (FIREYE serial communications protocol manual) for details.



1.8 Optional Oxygen Probe Interface Unit (NXO2INT) - optional

Supply voltage	115/230Vac \pm 15%
Power consumption	Approximately 60VA
Supply frequency	50/60Hz \pm 5%
Ambient temperature range	0 to 60°C (32 to 140°F)
Protection category	NEMA4 (IP65).
Unit dimensions	160 x 98 x 63mm (6.30 x 3.86 x 2.48") deep
Weight	1.34Kg (2.95 lbs)
Interface to PPC6000 series.	FIREYE specific CANbus.
Interface to oxygen probe.	FIREYE specific or 4-20mA

1.9 Optional Ambient Air Temperature Unit (NXIATS) - optional

Type	CANbus
Ambient temperature range	0 to 60°C (32 to 140°F)
Protection category	NEMA3 (IP54)
Unit dimensions	57 x 63 x 35 mm (2.25 x 2.5 x 1.37 inches)
Weight	0.15 kg (5.4 oz.)
Interface to PPC6000 series.	FIREYE specific CANbus.

1.10 Variable Speed Drive (VSD) Daughter Board (NXDBVSD) - optional

Ambient temperature range	0 to 60°C (32 to 140°F)
Protection category	Not applicable (fits inside PPC6000 unit).
Analog inputs (4 – 20mA)	3 max (non-isolated)
Input impedance	120ohms
Analog outputs (4 – 20mA)	3 max (isolated)
Maximum loop resistance	250 ohms
Isolation voltage	50v
RS485 communications.	Modbus RTU



1.11 Fireeye NXC04, NXC12, NXC20, NXC20A, NXC40 Servo Motors

Interface to PPC6000	CANbus															
Speed	30 seconds for 90 degrees.															
Microswitches	Open & close positions															
Torque	<table border="1"> <thead> <tr> <th></th> <th>Driving</th> <th>Holding</th> </tr> </thead> <tbody> <tr> <td>NXC04</td> <td>4Nm/ 3 ft/lb</td> <td>2Nm</td> </tr> <tr> <td>NXC12</td> <td>12Nm/ 9 ft/lb</td> <td>18Nm</td> </tr> <tr> <td>NXC20</td> <td>20Nm/ 14.7 ft/lb</td> <td>18Nm</td> </tr> <tr> <td>NXC40</td> <td>40Nm/ 29 ft/lb</td> <td>20Nm</td> </tr> </tbody> </table>		Driving	Holding	NXC04	4Nm/ 3 ft/lb	2Nm	NXC12	12Nm/ 9 ft/lb	18Nm	NXC20	20Nm/ 14.7 ft/lb	18Nm	NXC40	40Nm/ 29 ft/lb	20Nm
	Driving	Holding														
NXC04	4Nm/ 3 ft/lb	2Nm														
NXC12	12Nm/ 9 ft/lb	18Nm														
NXC20	20Nm/ 14.7 ft/lb	18Nm														
NXC40	40Nm/ 29 ft/lb	20Nm														
Voltage:	24-30Vac supplied from control only															
<u>VA rating</u>	<p>NXC04 = 3VA NXC12 = 5VA NXC20, NXC20A = 10VA NXC40 = 18VA</p>															
Protection Category	<p>NXC04 = IP40, NEMA 1 NXC12, NXC20, NXC20A = IP54, NEMA 3S NXC40 = IP65, NEMA 4</p>															
Typical accuracy	+/-0.1°															
Accuracy (as specified by EN12067)	+/-0.5°															

1.12 Fireeye NXO2INT Oxygen Probe Interface Unit (optional)

Supply voltage	115/230Vac \pm 15%
Power consumption	Approximately 60VA
Supply frequency	50/60Hz \pm 5%
Ambient temperature range	0 to 60°C (32 to 140°F)
Protection category	NEMA4 (IP65).
Unit dimensions	160 x 98 x 63mm (6.30 x 3.86 x 2.48") deep
Weight	1.34Kg (2.95 lbs)
Interface to PPC6000 / NX6100	FIREYE specific CANbus.
Interface to oxygen probe.	FIREYE specific or 4-20mA



1.13 Fireeye NXIATS Ambient Air Temperature Sensor (optional)

Type Ambient temperature range	CANbus -29°C to 60°C (-20°F to 140°F) NOTE: Accuracy below 0°C (32°F) may vary slightly. Agency testing conducted to 0°C only.
Protection category	NEMA3 (IP54)
Unit dimensions Weight	
Interface to PPC6000 / NX6100	FIREYE specific CANbus.

1.14 Approvals

Tested in accordance with the Gas Appliance Directive (GAD 90/396 EEC), encompassing the following standards:

- SIL Level 3 – Kiwa Gastec Report #123836
- ANSI/UL 462, Heat Reclaimers for Gas, Oil, or Solid Fuel-Fired Appliances
- ANSI/UL 1995, Heating and Cooling Equipment
- ANSI/UL 1998, Software in Programmable Components
- CAN/CSA-C22.2 No. 236, Heating and Cooling Equipment
- FM
- ENV1954, Internal and external behavior of safety related electronic parts
- EN60730-1, Automatic electrical controls for household and similar use
- prEN12067, Gas/air ratio controls for gas burners as gas burning appliances
- SIL level 3 per Kiwa report #123836

1.15 Parts List with Description

PART NO*	DESCRIPTION
PPC6000 FUEL AIR RATIO CONTROLLER	
PPC6000	Stand-alone parallel positioning controller, with up to ten (10) selectable function CANbus servo-motor outputs. Includes user configurable function blocks for custom applications. Display ordered separately.
DISPLAY MODULES FOR PPC6000	
NX610	CANbus display for PPC6000 with upload/download of PPC6000 data and three programmable relays
NXTSD104**	10.4" Touchscreen Display with upload/download, full commissioning, data log, internet connection, four programmable relays, 10 line voltage Digital Inputs.
SERVO-MOTORS FOR PPC6000	
NXC04	4 wire CANbus Servo-motor, 3 ft lbs. torque, 4 Nm, 50/60 Hz, 24 VAC.



PART NO*	DESCRIPTION
NXC12	4 wire CANbus Servo-motor, 9 ft lbs. torque, 12 Nm, 50/60 Hz, 24 VAC.
NXC20, NXC20A	4 wire CANbus Servo-motor, 14.75 ft lbs. torque, 20 Nm, 50/60 Hz, 24 VAC.
NXC40	4 wire CANbus Servo-motor, 29.5 ft lbs. torque, 40 Nm, 50/60 Hz, 24 VAC.
EXPANSION INTERFACE MODULES FOR PPC6000	
NXDBMB	Modbus RTU communications card
NXDBVSD	VSD interface daughter board with two VSD channels, one analog output, two counter inputs, two programmable relays, isolated RS485, Modbus RTU communications
NXO2INT	CANbus O2 interface module with Fireeye and generic (4-20mA) probe inputs.
O2 PROBES FOR PPC6000	
NXO2PK4	O2 probe assembly (for flues 300mm to 1000mm). Includes NXIATS CANbus ambient temperature sensor, flange kit.
NXO2PK6	O2 probe assembly (for flues 600mm to 2000mm). Includes NXIATS CANbus ambient temperature sensor, flange kit.
NXO2PK8	O2 probe assembly (for flues 1200mm to 4000mm). Includes NXIATS CANbus ambient temperature sensor, flange kit.
NXIATS	PPC6000 CANbus Inlet (ambient) Air Temperature Sensor Sensor -29°C to 60°C (-20°F to 140°F)
SENSORS FOR PPC6000	
PXMS-15	Steam Pressure Sensor: 0 - 15 PSI, 0 - 1 bar, 4-20mA output, 1/2" NPT, non self-check (for use with PPC6000).
PXMS-200	Steam Pressure Sensor: 0 - 200 PSI, 0 - 14 bar, 4-20mA output, 1/2" NPT, non self-check (for use with PPC6000).
PXMS-300	Steam Pressure Sensor: 0 - 300 PSI, 0 - 21 bar, 4-20mA output, 1/2" NPT, non self-check (for use with PPC6000).
BLPS-15	Steam Pressure Sensor: 0 - 15 PSI, 0 - 1 bar, 4-20mA output, 1/2" NPT, non self-check (for use with PPC5000 / PPC6000 / NX3100 / NX4100 / NX6100).
BLPS-30	Steam Pressure Sensor: 0 - 30 PSI, 0 - 1 bar, 4-20mA output, 1/2" NPT, non self-check (for use with PPC5000 / PPC6000 / NX3100 / NX4100 / NX6100).
BLPS-200	Steam Pressure Sensor: 0 - 200 PSI, 0 - 14 bar, 4-20mA output, 1/2" NPT, non self-check (for use with PPC5000 / PPC6000 / NX3100 / NX4100 / NX6100).
BLPS-300	Steam Pressure Sensor: 0 - 300 PSI, 0 - 21 bar, 4-20mA output, 1/2" NPT, non self-check (for use with PPC5000 / PPC6000 / NX3100 / NX4100 / NX6100).
TS350 (-2), (-4), (-8)	Temperature Sensor, Range 32°F-350°F (0-176°C), 4-20mA linear output, includes 1/2 - 14 NPT well. See bulletin BLZPTS-1 for complete description.
TS752 (-2), (-4), (-8)	Temperature Sensor, Range 32°F-752°F (0-400°C), 4-20mA linear output, includes 1/2 - 14 NPT well. See bulletin BLZPTS-1 for complete description.
SOFTWARE	
NXAM	ComFire communications software on CD for Nexus and PPC controls.
COMMUNICATION INTERFACE GATEWAY	
NXDBVSD	VSD interface daughter board with two VSD channels, one analog output, two counter inputs, two programmable relays, isolated RS485 – Modbus RTU communications
NXMBIV2	Modbus RTU Communications daughter board.

* FOR ADDITIONAL PARTS SEE FIREYE PRICE BOOK CG-14

** SOME FEATURES INCLUDED ON NXTSD MANUFACTURED AFTER MAY 2011.

2 Installation

This section contains basic installation information concerning choice of control and servomotor environment, wiring specification and connection details.



WARNING

**EXPLOSION OR FIRE HAZARD
CAN CAUSE PROPERTY DAMAGE,
SEVERE INJURY OR DEATH**

To prevent possible hazardous burner operation, verification of safety requirements must be performed each time a control is installed on a burner, or the installation modified in any way.

This manual may cover more than one model in the PPC6000 controls. Check for Additional Information at the end of this chapter.

This control must not be directly connected to any part of a Safety Extra Low Voltage (SELV) circuit.

WHEN INSTALLING THIS PRODUCT:

- Read these instructions carefully and ensure you fully understand the product requirements. Failure to follow them could damage the product or cause a hazardous condition.
- Check the ratings given in these instructions to ensure the product is suitable for your application.
- After installation is complete, check the product operation is as described in these instructions



CAUTION

- Disconnect the power supply before beginning installation to prevent electrical shock, equipment and/or control damage. More than one power supply disconnect may be involved.
- Wiring must comply with all applicable codes, ordinances and regulations.
- Loads connected to the PPC6000 series must not exceed those listed in the specifications as given in this manual.
- All external components connected to the control must be approved for the specific purpose for which they are used.

2.1 Mounting details for the PPC6000 control

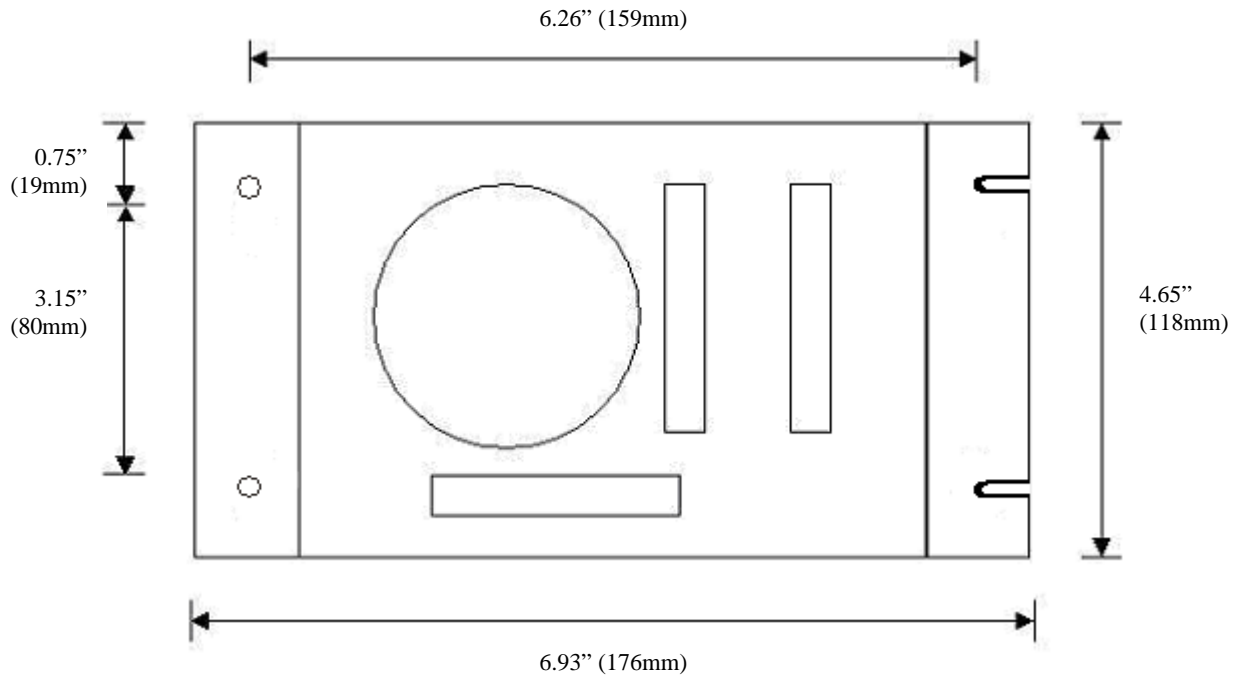

A Template for mounting is provided at the end of this manual for convenience. See Section 8.

There are two versions of the control, one that is intended to be mounted inside of a burner control cabinet, the other which has provision for conduit storage of field wiring etc. that can be mounted without the need for a burner control cabinet. If the version which is designed to be fitted inside of a burner control cabinet is being used the cabinet should have a minimum protection level of NEMA1 (IP40) for indoor use or NEMA3 (IP54) for outdoor use.

The control can be mounted in any attitude; clearances of a least 2.36-inch (60mm) should be left around the unit to allow sufficient space for wiring and to ensure reliable operation.

The ambient operating temperature range of the equipment is 0 to 60°C (32 to 140°F). Refer to section 7 for more details.

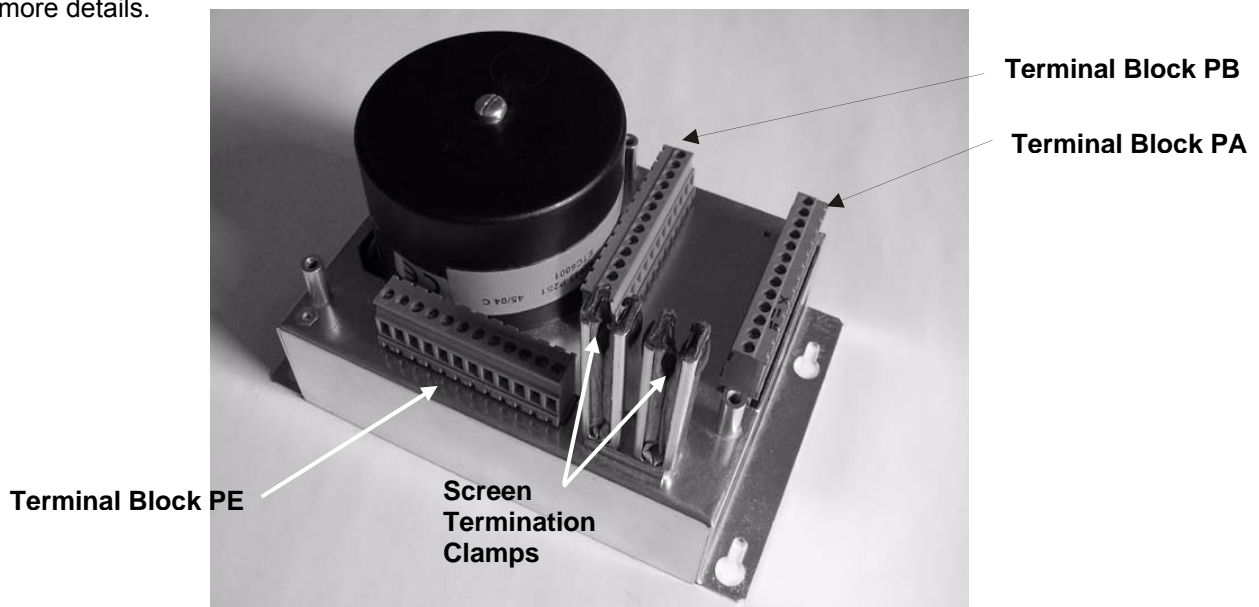

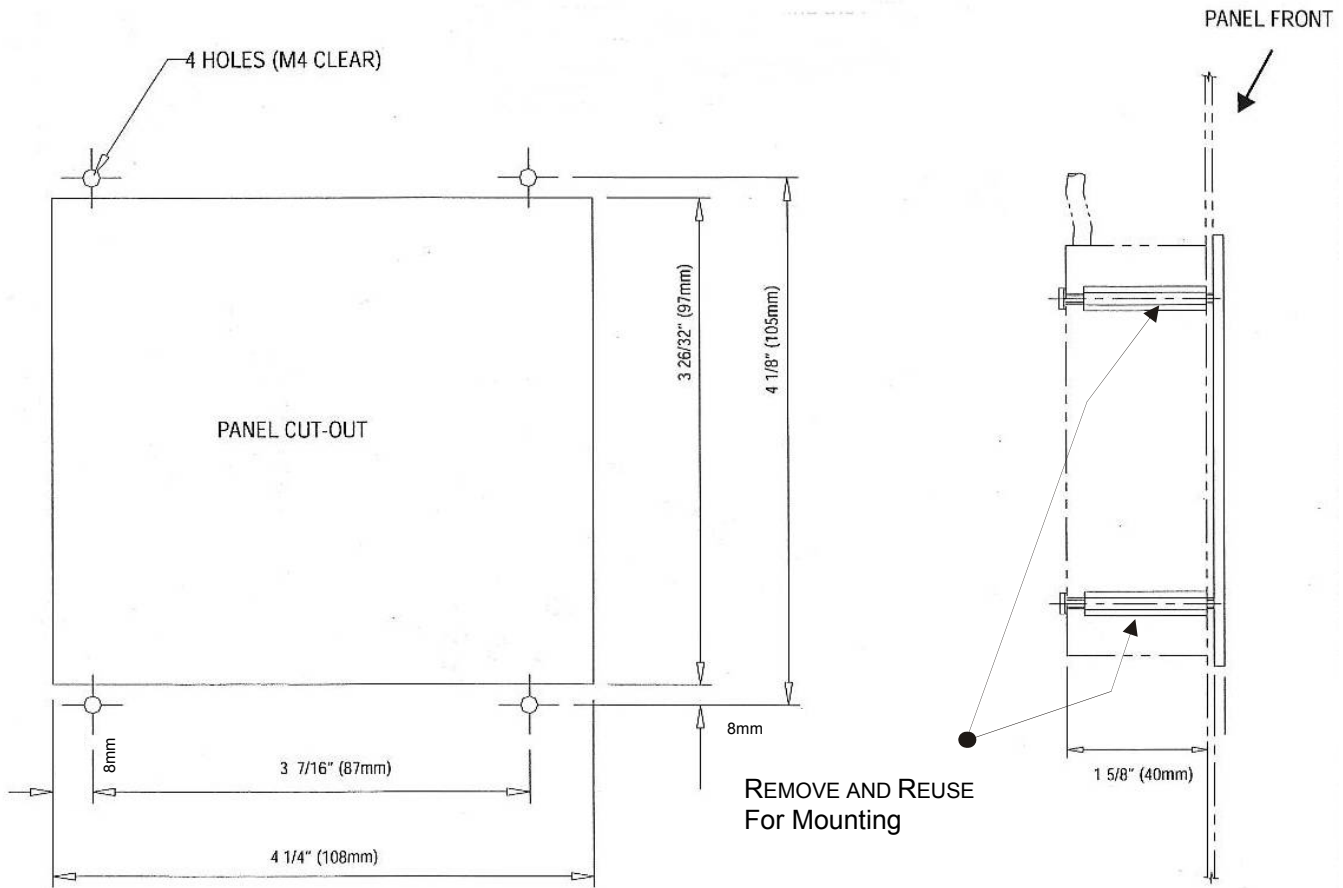

The display is held in using the four brass standoffs. The panel is cut out inside the four mounting holes only. Remove the four brass standoffs, insert the screw studs through the mounting holes, then re-install the brass standoffs. **Do not over tighten the standoffs.**

A Template for mounting is provided at the end of this manual for convenience. See Section 8.

2.3 Mounting details for optional Oxygen Probe Interface unit, NX02INT

A Template for mounting is provided at the end of this manual for convenience. See Section 8.

The optional oxygen probe interface unit is designed to be fitted either within a control cabinet or without a control cabinet; the unit has a protection level of NEMA4 (IP65) providing suitable conduit glands are used. The interface unit can be mounted in any attitude, clearances should be maintained around the conduit entries to the unit to allow sufficient space for wiring etc. the ambient operating temperature range is 0 to 60°C (32 to 140°F). The unit MUST be grounded (earthed) to maintain electrical safety and ensure reliable operation.

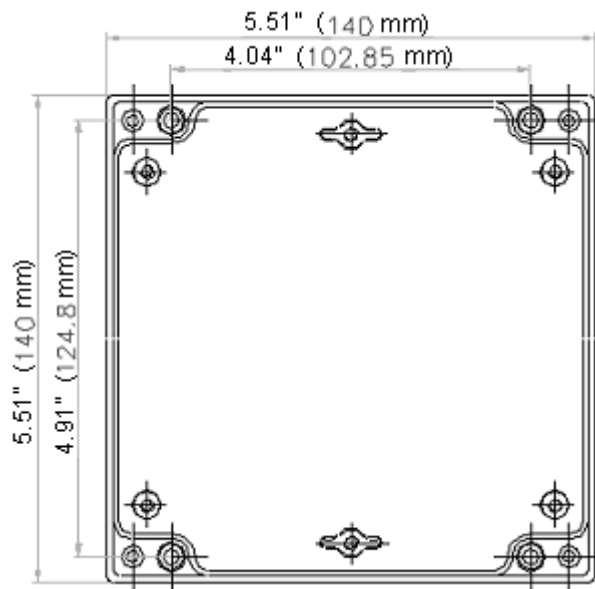

Enclosure is 2.8" (71mm) deep



Power CANbus and
Probe cable entry

2.4 The oxygen trim option



CAUTION

- Use extreme care when handling the oxygen probe and wear heatproof gloves.
- Ensure the burner is off before removing the oxygen probe from the flue.
- If the boiler is to be operated with the probe removed, fit the blanking cover supplied since dangerous levels of carbon monoxide may be present in the flue.

2.4.1 Oxygen Probe description

The oxygen trim / monitoring function is designed to be used with either an NXO2PK4, NXO2PK6, or NXO2PK8 oxygen probe. The probe offers fast, accurate response and good reliability when mounted in accordance with the guidelines in this section.

The probe is available in three different sizes.

2.4.2 Installation of oxygen probe

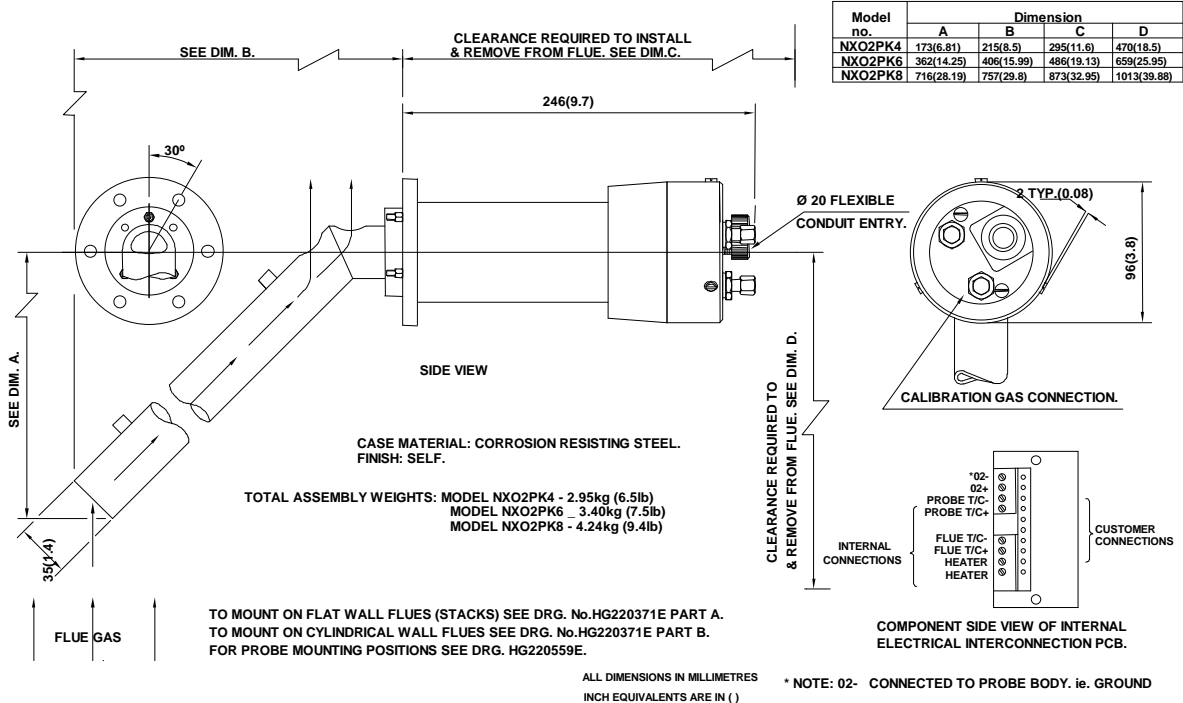

2.4.3 Mounting the oxygen probe

The probe must be mounted in a manner that ensures that the flue gases pass into the gas tube at its open end and out of the tube at the flange end. Furthermore, if possible, the flange should be vertical with the gas tube angled downwards to ensure that particulates do not build up within the sample tube. Probe mounting with the flange horizontal is acceptable. Inverted probe mounting is not acceptable.

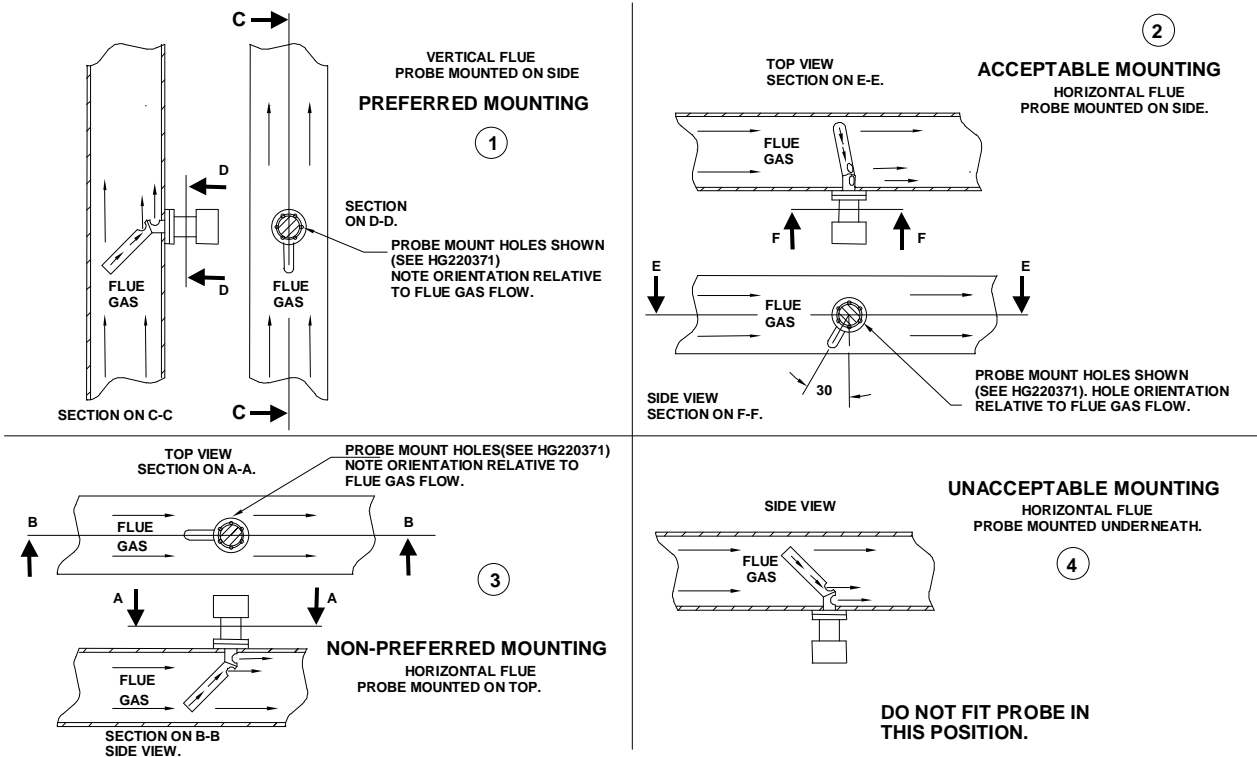

There are two types of flange available (see the drawing over the page). With either flange the vertical center line of the flange shown on the drawing should correspond to the gas flow direction.

6 stainless steel M6 x 20mm socket cap screws are provided for probe attachment.

The probe flange temperature must be maintained at the temperature of the flue wall by repacking or adding lagging, which may have been removed to mount the probe. Sulphate condensation will occur if the flue wall of an oil fired boiler falls below approximately 130°C. The sulphate problem does not occur in gas-fired installations, but vapor may cause problems due to condensation if the temperature of the flue gas falls below 100°C.

The maximum flue gas temperature is 1004°F (540°C).

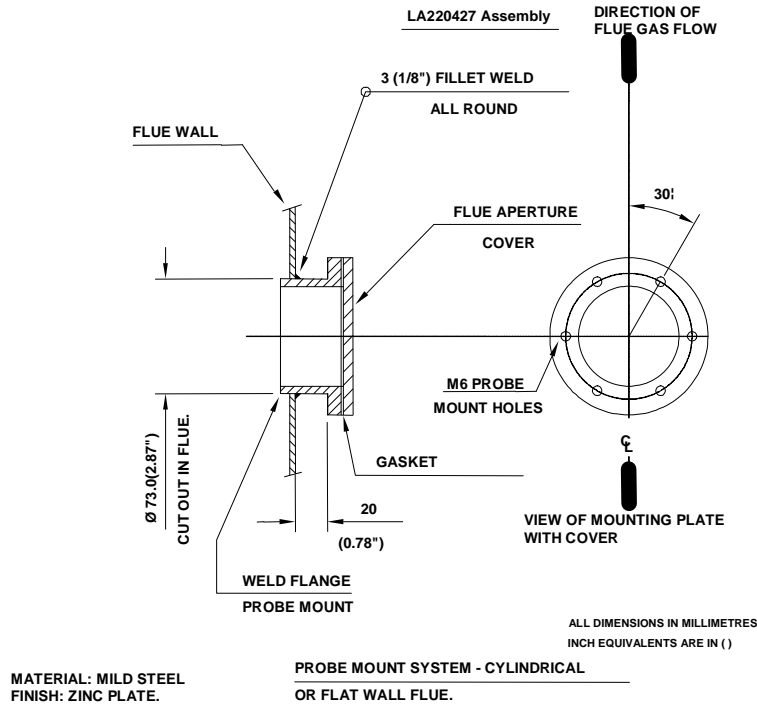

The probe end cap carries a removable 20mm (3/4") flexible conduit fitting to enable probe replacement without wiring. The 2 hexagonal caps visible on the probe rear face are there to cover the calibration gas port and the sample gas port. The latter is merely a tube that passes directly into the flue to enable gas samples to be drawn or flue temperatures to be taken using other instrumentation. Both ports must be kept sealed during normal operation for safety and accurate performance.

2.4.4 Mounting arrangements for Temperature and Steam pressure sensors

For full technical specifications of sensors see sections 2.4.5 and 2.4.6

2.4.5 Boiler temperature sensors





The temperature sensor has a protection level of NEMA4, providing suitable conduit glands are used and can be mounted in any attitude. It has been designed for mounting into a well, or pocket, that has been inserted into the boiler shell. When choosing the position of the well, care should be taken to ensure that the sensor operates within its environmental specifications, and that the position will allow measurements, and subsequent control actions, to be correlated to other devices e.g. auxiliary safety stats. The ambient operating temperature range is 0 to 60°C (0 to 140°F). The unit MUST be grounded (earthed) to maintain electrical safety and ensure reliable operation.

2.4.6 Steam pressure sensors

When fitting the sensor, care should be taken to ensure that the sensor operates within its environmental specifications. An important issue is the heating effect of the steam. Also, the sensor should be connected to the process in such a way that readings, and subsequent control actions, can be correlated to other devices e.g. the boiler pressure dial gauge and any auxiliary safety stats.

Steam Pressure sensors must be mounted in a vertical attitude to ensure water vapor does not collect inside the sensor. Additional devices, e.g. a “pig tail” feed pipe, may be required to reduce the possibility of moisture reaching the sensor during normal operation. Maintenance procedures should ensure that the sensor is inspected for evidence of condensates from the process collecting at the sensing point. If evidence of condensate is found, then preventative action must be taken to eliminate the cause.

The ambient operating temperature range is 0 to 70°C.
The unit MUST be earthed to maintain electrical safety and ensure reliable operation.

The conduit connection for steam pressure sensors is PG9, an adaptor for ½” NPSL is available. Fireeye ½” Conduit Adaptor P/N35-371.



2.5 Option link selection (PPC6000)

2.5.1 General (Access to jumper's and fuse's is gained by removing the back cover of the PPC6000)

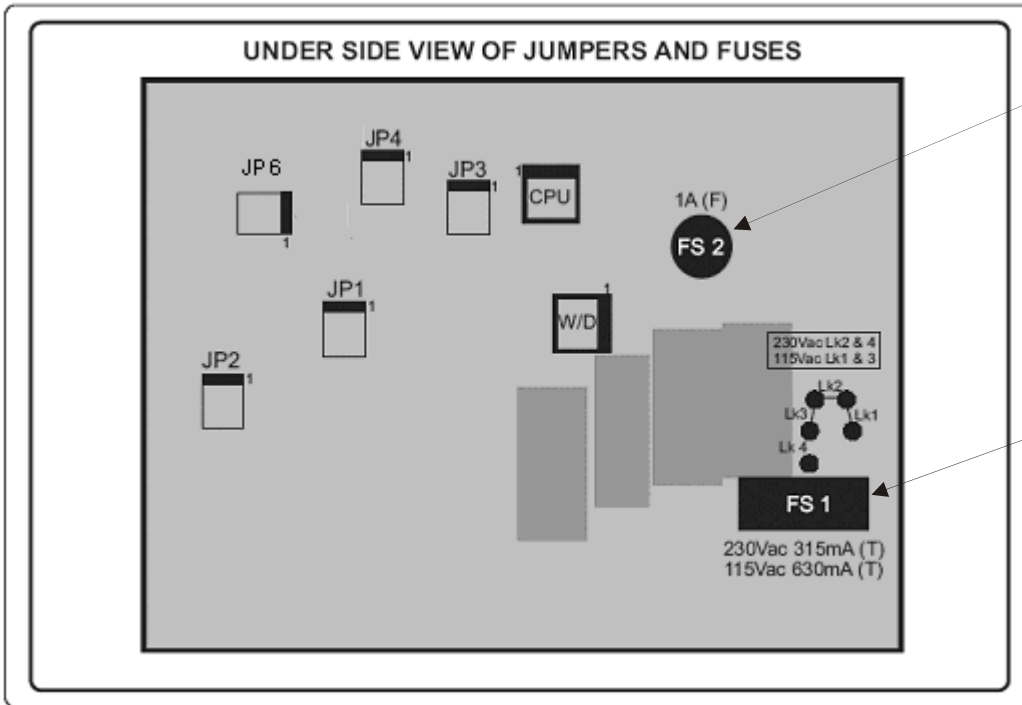

Wickmann-Littlefuse
 PN 3701100043
 1 AMP (Fast Acting)
 (to protect 5V DC circuit)
 Alternate Source:
 Mouser Electronics
 PN 576-371100000

Bussmann - S504 series
 P/N GMD-630 (Time Delay) for 115V
 P/N GMD-315 (Time Delay) for 230V
 (to protect 24V circuit)
 Alternate Source:
 Mouser Electronics
 PN 504-GMD-630mA
 PN 504-GMD-315mA

The PPC6000 has a number of option selection links, located on the circuit board. The function and settings are marked on the board alongside each link. **These links must be set to the correct position before power is applied to the control.** On some versions of the control additional details reference the option links and fuses are provided on a label attached to the mounting 'base', from which the product must be removed to gain access.

2.5.2 Line supply voltage (LK1 - 4) (PPC6000)



WARNING
 Incorrect setting of the Links **WILL** damage or destroy the unit.

The possible supply voltages are shown below, together with the necessary fuse rating. The correct fuse (type and rating) must be fitted; failure to do so may result in damage to the control.

Supply voltage (V)	Links required	Fuse rating (mA)
120	LK1 and LK3	630 anti-surge – TIME DELAY
230	LK2 and LK4	315 anti-surge – TIME DELAY

2.5.3 SENS IN and SENS SUPP (boiler temp/pressure sensor) (PPC6000)

If a boiler pressure/temperature sensor or modulation potentiometer is used, links JP3 and JP1 must be set to suit the type of sensor and voltage requirement. For example:

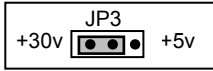

- For a 4-20mA loop-power sensor, choose a +30V supply.

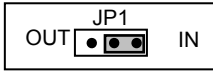

- For a 4-20mA loop-power sensor, choose current (IN) input.

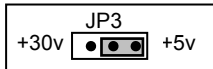

- For a 0-5V modulation signal, choose a +5V supply

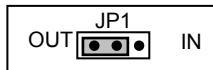

- For a 0-5V modulation signal, choose voltage (OUT) input

2.5.4 REMOTE SETPOINT (PPC6000)

If the remote setpoint or track signal is being used, link JP2 must be set to suit the type of signal. For example:

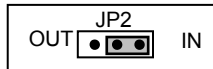

- For a current input set JP2 to IN position to ensure burden resistor *is* connected.

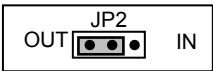

- For a voltage input signal set JP2 to OUT to ensure burden resistor *is not* connected.

2.5.5 RS485 serial communications termination resistor (PPC6000)

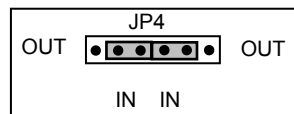

Please note that the RS485 serial communications supplied as part of the basic control is non-isolated, the termination resistor is selected by JP4. The two controls at the end of the communications bus should have this link set to the IN position. All other controls should have the link set to the OUT position. If only two controls are on the communications bus, set the links on both controls to the IN position.

2.5.6 RS485 serial communications termination resistor (daughter board)

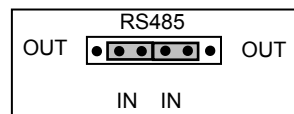

The optional daughter board provides an isolated RS485 serial communication function, the termination resistor is selected by **the RS485 (JP2) jumpers on the daughter board, but the terminals are provided as part of the PPC6000.** The two controls at the end of the communications bus should have both of the RS485 (JP2) links set to the IN position. All other controls should have the links set to the OUT position. If only two controls are on the communications bus, set the links on both controls to the IN position.

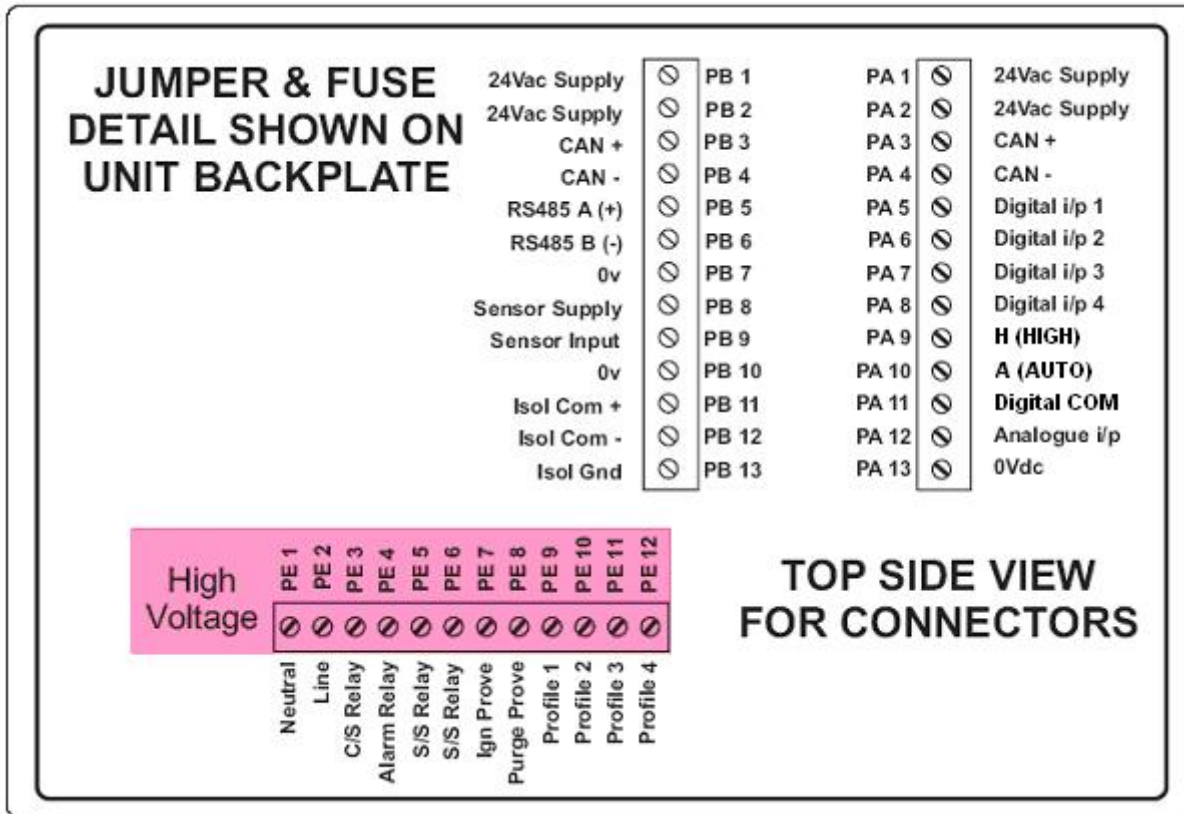

Note: All wiring to terminals PA & PB are low voltage and must be braided shielded wire per table 2.6.1A. Wiring to terminals “PE” are line voltage. The maximum wire size is 16AWG (19.3mm) for all terminals.

Note: PE7 & PE8 provide purge and low fire position signals to the flame safeguard control. These outputs **MUST NOT** have a load greater than 30mA (i.e. relays, lamp, etc.), damage to the PPC6000 will result. This connection **MUST** be braided shielded wire.



2.6 Wiring

Typical Schematic

An abbreviated typical wiring schematic diagram showing the PPC6000 Parallel Positioning Controller, YB110 Flame Safeguard Control and YZ300 Expansion Module can be found in section 9.6 in this manual.

This diagram is for reference only and may not meet all national or local codes. In all cases, local codes prevail with respect to the final installation of this product.

2.6.1 General

READ THIS FIRST!!!!

There are numerous mentions of "...overall braided shielded (screened) wire" throughout this manual. This is an important aspect to reliable operation. **Table 2.6.1-A lists the only approved wire** for this control. While one of the specifications relating to shielded wire indicates the amount of coverage (0-100%), this is not the only factor in selecting wire. While it is true, "foil and drain" shielded wire specifications indicate 100% coverage as compared to approximately 85% for braided type, the cross sectional area of the braid provides the required noise immunity. Also, the special grounding clamp bars on this control do not provide adequate connection to foil shield. In fact most foil shields do not conduct on the surface. **Using the "drain" wire to a ground stud does not properly protect the control.**



CAUTION

- Disconnect the power supply before beginning installation to prevent electrical shock, equipment and/or control damage. More than one power supply disconnect may be involved.
- Wiring must comply with all applicable codes, ordinances and regulations.
- Loads connected to the PPC6000 series, optional daughter board and optional oxygen probe interface must not exceed those listed in the specifications as given in this manual.
- Ensure the maximum total load on the CANbus cabling (servo-motors, display etc) is within the specifications of the PPC6000 and for the cable being used.
- This control **MUST NOT** be directly connected to any part of a Safety Extra Low Voltage (SELV) circuit.

WIRING INSTALLATION MUST BE CARRIED OUT BY A COMPETENT ELECTRICIAN AND IS SUBJECT TO I.E.E. WIRING REGULATIONS (BS 7671:1992), NEC AND/OR LOCAL STANDARDS, WHICH MAY PREVAIL.

HAZARDOUS VOLTAGES MUST BE ISOLATED BEFORE SERVICE WORK IS CARRIED OUT.

The PPC6000 unit **MUST** be mounted within a 'burner cabinet' or similar and **MUST** be grounded (earthed) to the overall enclosure to ensure safe and reliable operation.

Do not use a green or green/yellow conductor for any purpose other than ground (earth). The metal body of all component parts **MUST** be connected to ground (earth) using a green or green/yellow conductor.



The screen of the signal cable **MUST** not be used to provide the safety ground (earth), a separate connection using the largest cross-sectional area green or green/yellow ground (earth) wire possible **MUST** be made.

The screen termination clamps on the control are only provided to allow connection of the cable screens to the PPC6000 they do not provide strain relief. The signal cable screens **MUST** be connected at the screen termination clamps only, unless stated otherwise. **Screened cables MUST be of the 'copper braid shield' type** and not 'foil with drain wire', the cross section of the drain wire is insufficient to provide correct screening of the signals and there is also no provision to connect the foil or drain at the PPC6000.

Secure all cables carried in conduit at both ends using a suitable anchorage method in the cabinet.

All cabling that is required to operate at above 50v must be multi-strand single conductor (core), PVC insulated, 16 AWG (19/0.3mm) and should meet the requirements of I.E.C. 227 or I.E.C. 225, NEC

To comply with EMC requirements, wire the control and any optional units using the specified cable sizes and screen connections observing any maximum cable length limitations. **The manufacturer of this equipment recommends the use of bootlace ferules on all wire ends, as a "best practice"**.



Bootlace
Ferules

The equipment described in this manual has been tested for compliance to the CE and UL directives listed in the section headed 'approvals'. However, once connected to a burner and other associated controls it is the responsibility of the installer to ensure the complete installation meets the requirements of the UL or CE directives relevant to the particular installation.

IMPORTANT: Wiring Guidelines

NOTE: Interposing terminal blocks should be avoided when shielded cable is required. Interposing terminals present a risk of electrical noise interference resulting in unreliable operation.

All wiring to this control *must* comply with National, State and Local electrical codes. In general, all insulation must meet or exceed the highest voltage present on any conductor in a conduit, raceway or panel, e.g. 480 volt motor wiring would require at least 600-volt insulation. Consult the National Electric code for guidance.

IMPORTANT: Low Voltage (vertical terminal strips)

All low voltage circuits and communication wire must be fully shielded braided type wire of the specified gauge and number of conductors. **Table 2.6.1-A provides the only approved wire for this application. No "or equal" is provided. Use of wire not approved by Fireeye may VOID warranty.**

All wiring to terminal block "PA" & "PB" as well as to any optional daughter board (e.g. VSD) and the Power/CANbus wiring to the display, must be fully shielded braided wire per Table 2.6.1-A.

Under no circumstances should these input/outputs be connected to mains potential. Connection of any voltage above 5 volts to these terminals **will** damage or destroy the unit.



	Alpha (conductors)		Carol (conductors)		Belden (conductors)	
	4	2	4	2	4	2
300V	25164	25162	---		9940	
600V	25524	25522	C2688		7895A*	

* **NOTE:** If Belden 7895A wire is used it will be necessary to use 2 conduit adapters per device if wired as a “daisy chain.”
See Table 2.6.1-D

Table 2.6.1-A

IMPORTANT: Line Voltage (horizontal terminal bottom (PE) must NOT be shielded wire.

All line voltage wiring must be no greater than 16 AWG (19/0.3mm) THHN, TFFN or equal.
The following table provides a guide for converting from NEMA Enclosure Type Numbers of IEC Enclosure Classification Designations.
The NEMA Types meet or exceed the test requirements for the associated IEC Classifications; for this reason the table should not be used to convert from IEC classifications to NEMA Types and the NEMA to IEC conversion should be verified by test.

NEMA Enclosure Type Number	IEC Enclosure Designation
1	IP10/IP40/IP20
2	IP11
3	IP54
3R	IP14
3S	IP54
4 and 4X	IP56
5	IP52
6 and 6P	IP67
12 and 12K	IP52
13	IP54

Table 2.6.1-B

International Wire Size Conversion Table: All dimensions shown are as accurate as possible, however, when converting AWG, SWG, inches and metric dimensions, round-off errors do occur. Wire and cable also vary depending upon manufacturer.

American or Brown & Sharpe's AWG	British Standard SWG	Nominal Conductor Diameter (0) (inches)	Fractional Equivalent (inches)	Nominal Conductor Diameter (0) (mm)	Cross Sectional Conductor Area Sq mm (mm ²)	** Stranded Wire Construction	
						Number of Strands x Diameter of Strands (inches)	(mm)
16	-	0.051	-	1.30	1.33	26 x .010	19 x .30
18	19	0.040	-	1.02	0.82	16 x .010	7 x .4
20	21	0.032	-	0.81	0.52	10 x .010	16 x .2
24	25	0.020	-	0.51	0.20	7 x .008	7 x .2

Table 2.6.1-C

CONDUIT CONNECTOR ADAPTERS	
Metric to ½ inch NPSL Female	
Device	Fireeye Part Number
NXC04 Servomotor	35-321
NXC12 Servomotor	35-321
NXC20, NXC20A Servomotor	35-322
NXC40 Servomotor	35-372
NXIATS Inlet Air Sensor	35-336
NXO2INT Oxygen Interface	35-372
All O2 Probe Assembly	35-372

Table 2.6.1-D

2.6.2 Grounding cable screens

Two screen termination clamps are provided on the PPC6000 for termination of cable screens (copper braid type) where necessary, if the unit is used with a daughter board the screens of these cables **MUST** also be terminated to the cable clamps and the screen and associated insulation left on the cable until as close as possible to the terminals to which they are connected. Where screened cables are required to run through one unit to connect to another a terminal is provided to allow the screens to be connected, by forming a 'tail' with the braided screen of each cable, the length of unscreened cable should be kept as short as possible but in any case **MUST** not exceed 1³/₁₆" (30mm), per cable 'tail'.

Connect all signal cable 'braid' screens to ground (earth) using the screen termination clamps provided on the control. Connect all cable screens to ground (earth) at the control only, with the exception of the cables that connect the temperature and pressure sensors where fitted. Where the wiring is 'run through' one unit to connect to another terminals are provided to ensure the screen connection is maintained.

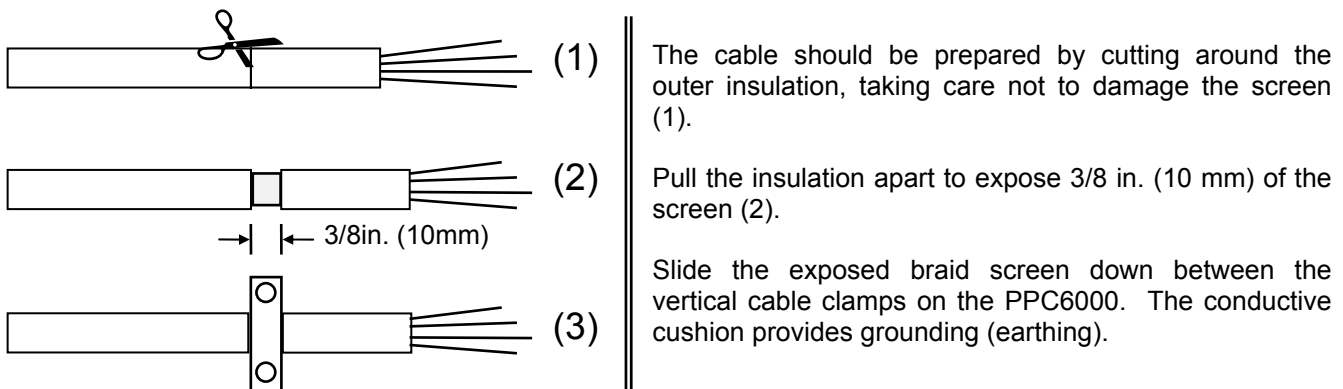

2.6.3 GROUND (EARTH) connection

The PPC6000 **MUST** be connected to ground (earth); the connection should be made at the stud with the tag showing the Ground (earth) symbol. This connection is required to maintain the overall electrical safety of the installation and ensure the EMC performance of the equipment; failure to comply with the wiring requirements will affect the performance of the system and may cause a hazardous condition to occur. Ensure that a good electrical connection is made between both the unit and the burner panel then between the burner panel and ground (earth). Where necessary, scrape any paint away from connection points and use shake-proof washers to ensure a reliable electrical connection. Always use the largest cross-sectional area ground (earth) wire possible.



2.6.4 Ground (earth) Connection (*display unit*)

The display unit MUST be connected to ground (earth); the connection should be made at the stud with the tag showing the Ground (earth) symbol. This connection is required to maintain the overall electrical safety of the installation and ensure the EMC performance of the equipment; failure to comply with the wiring requirements will affect the performance of the system and may cause a hazardous condition to occur. Ensure that a good electrical connection is made between both the unit and the burner panel then between the burner panel and ground (earth). Where necessary, scrape any paint away from connection points and use shake-proof washers to ensure a reliable electrical connection. The screen of the signal cable MUST not be used to provide the electrical safety ground (earth), a separate connection using the largest cross-sectional area ground (earth) wire possible MUST be made.

If the display unit is mounted into a burner cabinet door ensure there is a good electrical connection between the door and the main cabinet in addition to a good electrical contact between the display unit and the door.

2.6.5 Terminal Designation

All terminals within the system have 'unique' terminal designations to reduce the possibility of wiring errors. This information is tabulated below:

Terminal Number	Location	Function	Voltage Range
PA1	PPC6000	24Vac Supply for Servos, Display etc.	24 – 40Vac
PA2	PPC6000	24Vac Supply for Servos, Display etc.	24 – 40Vac
PA3	PPC6000	CAN + (CANbus)	0 – 5V
PA4	PPC6000	CAN - (CANbus)	0 – 5V
PA5	PPC6000	Digital Input 1	0 – 5Vdc
PA6	PPC6000	Digital Input 2	0 – 5Vdc
PA7	PPC6000	Digital Input 3	0 – 5Vdc
PA8	PPC6000	Digital Input 4	0 – 5Vdc
PA9	PPC6000	High purge request	0 – 5Vdc
PA10	PPC6000	Auto	0 – 30Vdc
PA11	PPC6000	Digital Input Common	0 – 5V
PA12	PPC6000	Analog Input 5 (Aux mod./remote Setpoint)	0 – 5Vdc
PA13	PPC6000	Sensor Supply (+30Vdc)	0-30Vdc
PB1	PPC6000	24Vac Supply for Servos, Display etc.	24 – 40Vac
PB2	PPC6000	24Vac Supply for Servos, Display etc.	24 – 40Vac
PB3	PPC6000	CAN + (CANbus)	0 – 5V
PB4	PPC6000	CAN - (CANbus)	0 – 5V
PB5	PPC6000	RS485 comms A (+)	0 – 5V
PB6	PPC6000	RS485 comms B (-)	0 – 5V
PB7	PPC6000	RS485 comms 0 Volt (not shield)	0 – 5V
PB8	PPC6000	Sensor Supply (30V)	0 – 5V
PB9	PPC6000	Sensor Input	0 – 5V
PB10	PPC6000	Sensor 0 Volt (not shield)	0 – 5V
PB11	PPC6000	Isolated comms (Modbus) A+	0 – 5V
PB12	PPC6000	Isolated comms (Modbus) B -	0 – 5V
PB13	PPC6000	Isolated 0 Volt (Modbus)	0 – 5V
PE1	PPC6000	PPC6000 neutral (L2)	115 - 230Vac
PE2	PPC6000	PPC6000 live (L1)	115 - 230Vac
PE3	PPC6000	Controlled Shutdown relay output	0 – 230Vac
PE4	PPC6000	Alarm Relay	0 – 230Vac
PE5	PPC6000	S/S Relay	0 – 230Vac



Terminal Number	Location	Function	Voltage Range
PE6	PPC6000	S/S Relay	0 – 230Vac
PE7	PPC6000	Ign Prove (Low Fire output)	0 – 230Vac
PE8	PPC6000	Purge Prove (High Purge output)	0 – 230Vac
PE9	PPC6000	Profile 1 Select	0 – 230Vac
PE10	PPC6000	Profile 2 Select	0 – 230Vac
PE11	PPC6000	Profile 3 Select	0 – 230Vac
PE12	PPC6000	Profile 4 Select	0 – 230Vac
PK1	On Servomotor	24Vac Supply	24 – 40Vac
PK2	On Servomotor	24Vac Supply	24 – 40Vac
PK3	On Servomotor	CAN +	0 – 5V
PK4	On Servomotor	CAN -	0 – 5V
PK5	On Servomotor	Screen connection	Not applicable
PL1	Oxygen Interface	Unit Supply (live L1)	115 - 230Vac
PL2	Oxygen Interface	Unit Supply (neutral L2)	115 - 230Vac
PL3	Oxygen Interface	CAN +	0 – 5V
PL4	Oxygen Interface	CAN -	0 – 5V
PL5	Oxygen Interface	Analog input 2 (NA - future)	0 – 5V
PL6	Oxygen Interface	Analog input 1 (4 – 20mA O ₂ third party probe.	0 – 5V
PL7	Oxygen Interface	Analog input 0v	0 – 5V
PM2	Oxygen Interface	Oxygen Cell mV (-)	0 – 100mVdc
PM3	Oxygen Interface	Oxygen Cell mV (+)	0 – 100mVdc
PM4	Oxygen Interface	Oxygen Cell Temperature (-)	0 – 100mVdc
PM5	Oxygen Interface	Oxygen Cell Temperature (+)	0 – 100mVdc
PM6	Oxygen Interface	Flue Temperature (-)	0 – 100mVdc
PM7	Oxygen Interface	Flue Temperature (+)	0 – 100mVdc
PM8	Oxygen Interface	Heater Output	0 – 40Vac
PM9	Oxygen Interface	Heater output	0 – 40Vac

NX610 Display Relays – General Purpose Shown
For Alarm, see Section 5.5.1 Option 17.x Table A

PR1	Display Unit	Relay output 1 normally open	0 – 250V
PR2	Display Unit	Relay output 1 normally closed	0 – 250V
PR3	Display Unit	Relay output 1 common	0 – 250V
PR4	Display Unit	NO CONNECTION	N/A
PR5	Display Unit	Relay output 2 normally open	0 – 250V
PR6	Display Unit	Relay output 2 normally closed	0 – 250V
PR7	Display Unit	Relay outputs 2 & 3 common	0 – 250V
PR8	Display Unit	Relay output 3 normally closed	0 – 250V
PR9	Display Unit	Relay output 3 normally open	0 – 250V

NXTSD104 Touchscreen Display Relays – General Purpose Shown
For Alarm, see Section 5.5.1 Option 17.x Table C

PR1	Display Unit	Relay output 1 common	0 – 250V
PR2	Display Unit	Relay output 1 normally closed	0 – 250V
PR3	Display Unit	Relay output 1 normally open	0 – 250V
PR4	Display Unit	Relay output 2 common	0 – 250V
PR5	Display Unit	Relay output 2 normally closed	0 – 250V
PR6	Display Unit	Relay output 2 normally open	0 – 250V



Terminal Number	Location	Function	Voltage Range
PR7	Display Unit	Relay output 3 common	0 – 250V
PR8	Display Unit	Relay output 3 normally closed	0 – 250V
PR9	Display Unit	Relay output 3 normally open	0 – 250V
PR10	Display Unit	Relay output 9 common (TSD104 only)	0 – 250V
PR11	Display Unit	Relay output 9 normally closed (TSD104 only)	0 – 250V
PR12	Display Unit	Relay output 9 normally open (TSD104 only)	0 – 250V
PT1	Display Unit	24Vac Supply	24 – 40Vac
PT2	Display Unit	24Vac Supply	24 – 40Vac
PT3	Display Unit	CAN +	0 – 5V
PT4	Display Unit	CAN -	0 – 5V
STUD	Display Unit	Screen connection	Not applicable
PZ1	Daughter Board	Channel 1 output [4-20mA] (-)	0 – 20V
PZ2	Daughter Board	Channel 1 output [4-20mA] (+)	0 – 20V
PZ3	Daughter Board	Channel 2 output [4-20mA] (-)	0 – 20V
PZ4	Daughter Board	Channel 2 output [4-20mA] (+)	0 – 20V
PZ5	Daughter Board	Channel 3 output [4-20mA] (-)	0 – 20V
PZ6	Daughter Board	Channel 3 output [4-20mA] (+)	0 – 20V
PZ7	Daughter Board	Encoder (proximity counter) Feedback 1	0 – 12V
PZ8	Daughter Board	Encoder Supply	12Vdc
PZ9	Daughter Board	Encoder (proximity counter) Feedback 2	0 – 12V
PZ10	Daughter Board	Encoder Supply	12Vdc
PZ11	Daughter Board	Encoder Feedback 3	0 – 12V
PZ12	Daughter Board	Channel 1 Feedback [4-20mA] (-)	0 – 5Vdc
PZ13	Daughter Board	Channel 1 (+) & Channel 2 (-)	0 – 5Vdc
PZ14	Daughter Board	Channel 2 Feedback [4-20mA] (+)	0 – 5Vdc
PZ15	Daughter Board	Relay output 7 common	0 – 40V
PZ16	Daughter Board	Relay output 7 normally open	0 – 40V
PZ17	Daughter Board	Relay output 8 common	0 – 40V
PZ18	NXDBVSD	Relay output 8 normally open	0 – 40V

2.6.6 LINE and NEUTRAL supply (PPC6000) PE1 & PE2



WARNING

Incorrect setting of the Supply Voltage Links **WILL** damage or destroy the unit.

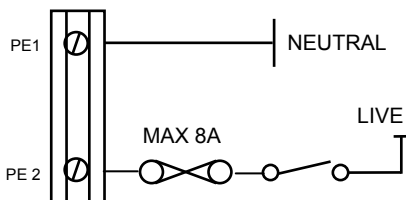

The LINE and NEUTRAL supplies must be connected using multi-strand single conductor (core) PVC insulated 16 AWG (19/0.3mm) wire. The live connection **MUST** be fused with a **maximum rating** as shown.

NOTE: Line (live) is term PE2. If a fuse greater than 8A is fitted, each relay (safety shutdown and controlled shutdown) output supplied via this terminal **MUST** be separately fused at 8A maximum, to protect the relay contacts from 'welding'. It is also recommended that the alarm relay be fused at 4A maximum to protect the relay contacts from 'welding', which may cause incorrect alarm indication.

2.6.7 Safety Shutdown output (PPC6000)

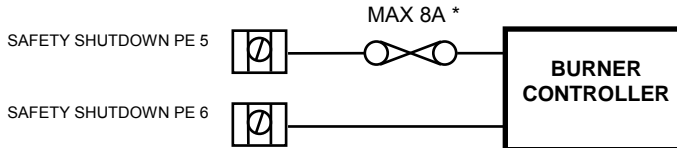

The safety shutdown relay output must be connected using multi-strand single conductor (core) PVC insulated 16 AWG (19/0.3mm) wire. This output must be connected to ensure the burner will shutdown if no output is present.

*** If a control panel fuse greater than 8A is fitted, the safety shutdown output terminal **MUST** be separately fused at 8A maximum.**

2.6.8 Controlled Shutdown Relay Output (PPC6000)



WARNING

- Any external limit device, if fitted must be connected into the controlled shutdown circuit, unless connected into the auxiliary inputs and the correct function selected.
- If a limit device is fitted into the controlled shutdown circuit it must be capable of supplying the total current required by devices connected to this circuit.
- Any limit device connected to the PPC6000 series control must be approved for the specific purpose for which it is being used.
- Wiring must comply with all applicable codes, ordinances and regulations.

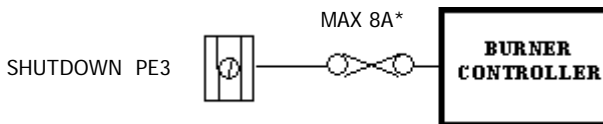

The controlled shutdown relay output must be connected using multi-strand single conductor (core) PVC insulated 16 AWG (19/0.3mm) wire.

If a control panel fuse greater than 8A is fitted, the controlled shutdown circuit **MUST be separately fused at 8A maximum to protect the relay contacts from 'welding'.**

2.6.9 Alarm Relay output – RELAY 4 (on the PPC6000) (See option parameter 14.7 for further programming options.)

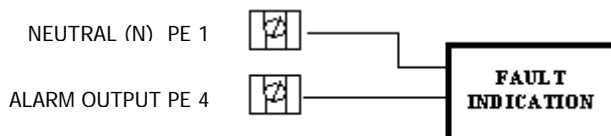

The alarm relay output must be connected using multi-strand single core PVC insulated 16 AWG (19/0.3mm) wire. This (line voltage) output must only be used for indication, as it is not fail-safe. **If a fuse greater than 4A is fitted in the supply to**

the control, it is recommended the alarm relay output be separately fused at 4A maximum.

NOTE: Relays 1 to 3 are (optionally) provided on the display board. Relays 5 and 6 are reserved for future products. Relays 7 and 8 are (optionally) provided on the daughter board.



2.6.10 Auxiliary Relay Outputs (*display*)

- RELAY 1 NORMALLY OPEN PR 1
- RELAY 1 NORMALLY CLOSED PR 2
- RELAY OUTPUTS 1 COMMON PR 3
- NO CONNECTION PR 4
- RELAY 2 NORMALLY OPEN PR 5
- RELAY 2 NORMALLY CLOSED PR 6
- RELAY 2 & 3 COMMON PR 7
- RELAY 3 NORMALLY CLOSED PR 8
- RELAY NORMALLY OPEN PR9



NOTE: The above is for Alarm Function – See Option 14.1, 14.2 and 17.x for important details

Fuses not exceeding 4A must protect all relay outputs. If a control panel fuse greater than 4A is fitted, the relay common MUST be separately fused at 4A maximum. Where the total relay current exceeds 4A, fit a separate fuse on each relay output to achieve this.

These outputs must be connected using multi-strand single core PVC insulated 16 AWG (19/0.3mm) wire. Since this cable may be run in conduit with high voltage wiring, its voltage rating must exceed the maximum voltage carried by any other cable connected to the control or run in the same conduit.

The 3 auxiliary relays provide volt free change over contacts. Two of the relays (2&3) share a common voltage source. The relays are separated on the circuit board to allow either the pair sharing the common or the single relay to operate at high voltage while the other(s) operate at low voltage. Alternatively all relays may operate at the same voltage. The relay functions can be set via the option parameter, or via the programmable blocks. **See Option 17.x for important details regarding these relays.**

2.6.11 Fuel Select /Profile Select Input/Purge and Ignition Prove Outputs (*PPC6000*)

The four fuel-profile select inputs are designed for operation at between 120 & 230Vac. (*relevant Engineer's Keys EK11-EK14, section 6.6.2*)

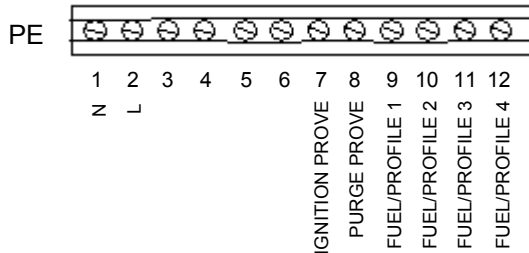

These inputs must be connected using multi-strand single core PVC insulated 16 AWG (19/0.3mm) wire. Since this cable is to be run adjacent to, and/or in the same conduit as high voltage wiring, its voltage rating must exceed the maximum voltage carried by any other cable connected to the control or run in the same conduit.

Note: PE7 and PE8 provide purge and low fire position signals to the flame safeguard control. These outputs **MUST NOT** have a load greater than 30mA (i.e. relays, lamp, etc.), damage to the PPC6000 will result.

READ THIS FIRST!!!!

There are numerous mentions of "...overall braided shielded (screened) wire" throughout this manual. This is an important aspect to reliable operation. Table 2.6.1-A lists **THE ONLY APPROVED WIRE** for this control. While one of the specifications relating to shielded wire indicates the amount of coverage (0-100%), this is not the only factor in selecting wire. While it is true, "foil and drain" shielded wire specifications indicate 100% coverage as compared to approximately 85% for braided type, the cross sectional area of the braid provides the required noise immunity. Also, the special grounding clamp bars on this control do not provide adequate connection to foil shield. In fact most foil shields do not conduct on the surface. Using the "drain" wire to a ground stud does not properly protect the control.

NOTE: If wire entrances to terminals face inward (under the cover), then these wires require *braided shielded wire*. If the terminals face outward, **NO** braided wire is to be used.

2.6.12 Low Voltage Digital Inputs (PPC6000) – relevant Engineer’s Keys EK1-EK4 (Sec. 6.6.2)
(See option parameter 16.1 and 18.1-18.4 for further details.)

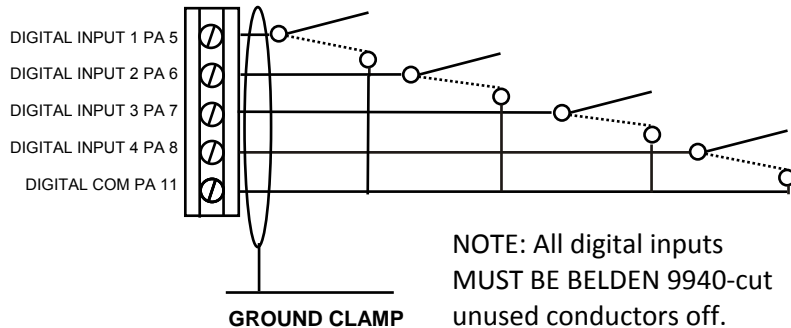

These inputs must be connected using multi-strand overall screened two conductor PVC insulated 24 AWG (7/0.2mm) wire. (See Table 2.6.1-A, Section 2.6.1) Note that these inputs are dynamic low voltage (0/5V) signals and must be connected between the relevant terminals provided. Measuring the voltage between any input and PA11 will indicate 0 volts with input closed,

up to 5V with input open. As it is a dynamic input, the voltage will not be a steady 5V DC. Since this cable is to be run adjacent to, and/or in the same conduit as high voltage wiring, its voltage rating must exceed the maximum voltage carried by any other cable connected to the control or run in the same conduit. (See Section 2.6.1, IMPORTANT Wiring Guidelines)

These functions are all fail-safe and may be used to lockout or shutdown the burner. The fault number generated always relates directly to the input that caused the fault (by going open circuit). Thus F1 comes from input 1, F2 comes from input 2 and F4 comes from input 4. The lockout functions themselves are activated by putting a number into option parameters 18.1 to 18.4 for inputs 1 to 4. The number is a one, two or three digit number. **See option parameter 18.1 to 18.4 for settings.**

Under no circumstances should these input/outputs be connected to mains potential. Connection of any voltage above 5 volts to these terminals **will** damage or destroy the unit.

2.6.13 Servo-motor and Display Connection (PPC6000)

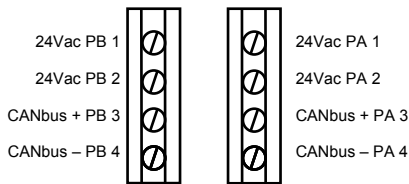

There are 2 sets of terminals available for the CANbus connection - both sets are identical.

CANbus allows several options for connecting the units together, based on the actual position of each unit relative to the PPC6000 and the current required by each unit. The recommended cable, overall

screened 4-core PVC insulated minimum 24 AWG (7/0.2mm) wire, has a maximum current capability at 60°C (140°F) of 600mA (Belden 7895A or equal) which will limit the maximum number of units which can be connected via a single ‘bus’. Since this cable is to be run adjacent to, and/or in the same conduit as high voltage wiring, its voltage rating must exceed the maximum voltage carried by any other cable connected to the control or run in the same conduit. **(See Table Section 2.6.1)**

Once the location of each unit is defined (usually by the mechanics of the burner/boiler the ‘best’ cable route to each device can be selected. If required several cables can be run directly from the PPC6000 or a single cable can be ‘looped through’ (daisy chain) all the connected units, providing the maximum current capability of the cable is not exceeded.

Where the maximum current required on the cable exceeds 600mA (for example when using 50Nm servo – motors which are rated at 15VA) suitable overall screened 4 conductor (core) cable must be substituted. Use of 2 overall screened cables (one for the CAN and one for the power is not recommended since this would increase the number of ‘screens’ to be connected in each device for which there is no provision.

Connect the screen with the use of the screen termination clamp, at the PPC6000. If wiring is being ‘looped through’ units, ensure that the screen of the cable is connected to the terminals provided to ensure continuity of the screen. **Incorrect connection may damage or destroy the units being connected.**

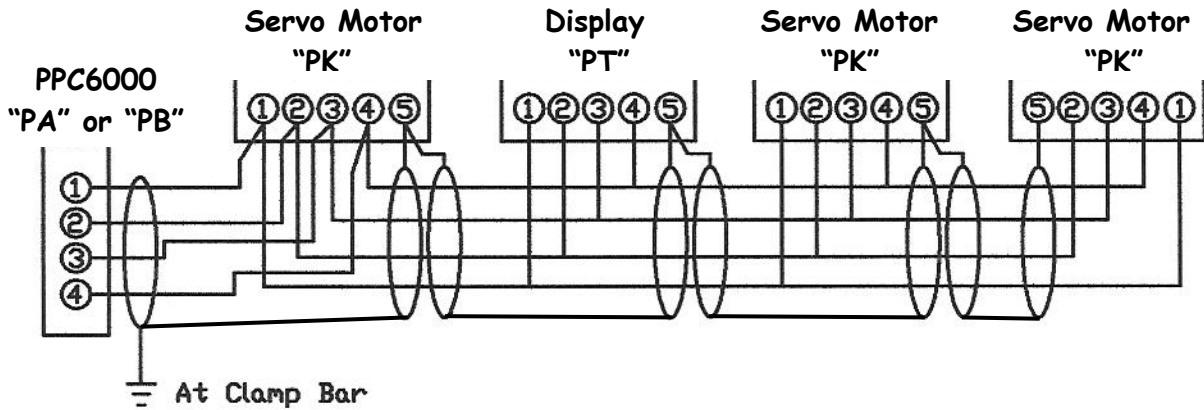

NOTE: Interposing terminal blocks should be avoided when shielded cable is required. Interposing terminals present a risk of electrical noise interference resulting in unreliable operation.

2.6.14 Display Connection with PPC6000 and BurnerLogix YB110

Connect the touchscreen display (TSD) to the PPC6000 using shielded cable from positions PA1-PA4 or PB1-PB4. Terminate wires to the 4 position terminal block on the back of the touch-screen display.

Connect the YB110 using the three terminal connector labeled A+, B-, 0 volt. The A+ & B- connections are connected to the Fireeye ED610 terminal block (purchased separately) on terminals 10 & 9 (A & B), the 0 volt connection is not used. The ED610 is connected to the YB110 via an ED512-4 cable (purchased separately).

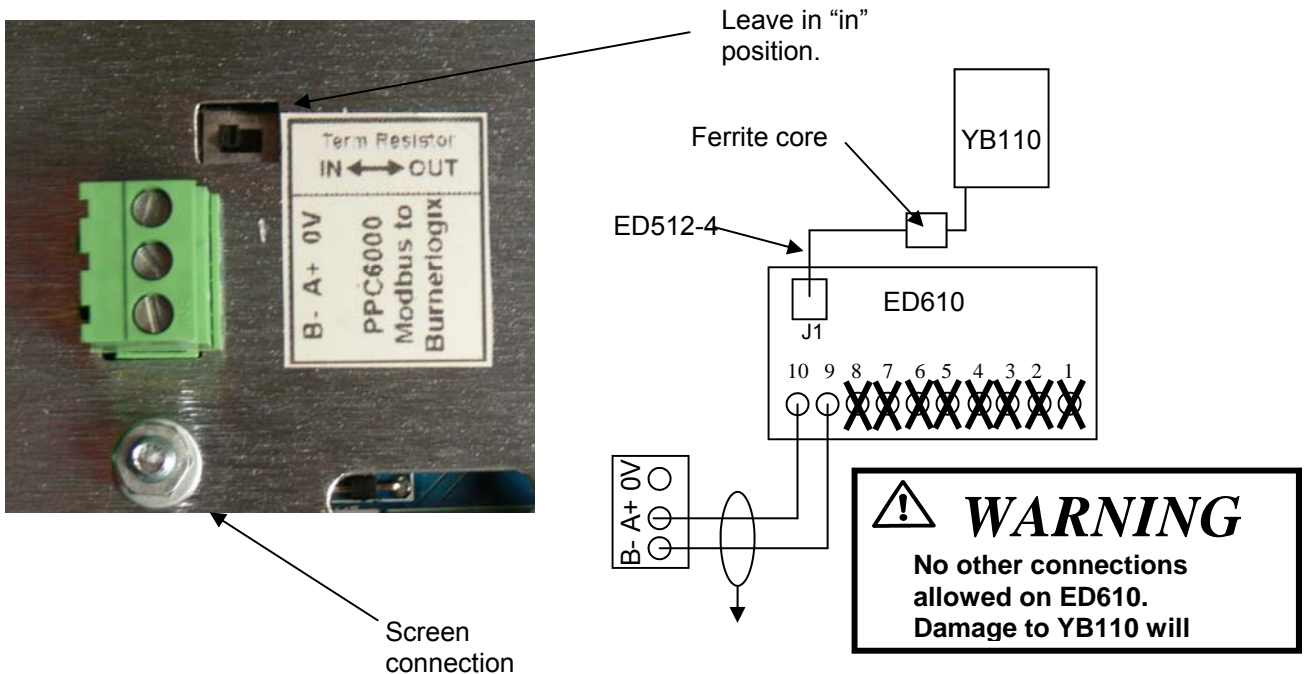

TSD104 setup for use with YB110

After wiring the YB110 to the TSD as shown above, the TSD must be told to communicate to the YB110 via Modbus. With the burner off, enter full commissioning mode. (see section 5.3.1.1) by pressing: Menu, Burner Setting (enter suppliers passcode LV3), then , Menu, Screen Configuration, Display. Press the Modbus Configuration button. The default is Integrated NX6100. Next set the Modbus Node id to match the YB110, for example,1. See Fireeye bulletin BL-1001 for details as to configuring the Modbus in the BurnerLogix. At this point you will set the current Modbus configuration to PPC/BurnerLogix. When the dialog box appears, press

Change. Next, press the RS485 Comms button and select the baud rate that matches the BurnerLogix YB110. The default is 9600,N,1. The currently displayed message from the YB110 display should now appear in the lower right section of the TSD. Any status or lockout messages for the YB110 will be displayed here also. The fault numbers assigned to YB110 lockouts is the Modbus message number (found in BL-1001) plus 200. For example, if the YB110 locked out during PTFI, the message on the TSD104 would be: F207 LOCKOUT FLAME FAILURE_PTFI. That is, Modbus message number 7+200= F207. **See Section 6.8 for a list of TSD Fault messages.**



Caution

Do **NOT** mechanically connect the servomotor to the driven shaft *until* the servo-motor direction has been established and set. See section 3.2 for details.

2.6.15 Oxygen Probe Interface Connection (PPC6000)

The Oxygen Probe Interface is not powered from the PPC6000; therefore only CANbus signals need to be derived from the PPC6000 and not the power.

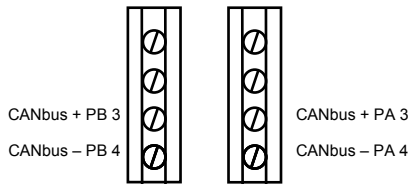

The recommended cable, for this (CANbus) connection is overall screened 2-core PVC insulated minimum 24 AWG (7/0.2mm) cable, since this cable is to be run adjacent to, and/or in the same conduit as high voltage wiring, its voltage rating must exceed the maximum voltage carried by any other cable connected to the control or run in the same conduit.

Connect the screen with the use of the screen termination clamp, at the PPC6000 and be cut back and insulated at the Oxygen Probe Interface.

Incorrect connection may damage or destroy the units being connected.

FOR MORE DETAILS: See section 2.6.18 thru 2.6.20

2.6.16 Pressure/temperature sensor input (PPC6000)

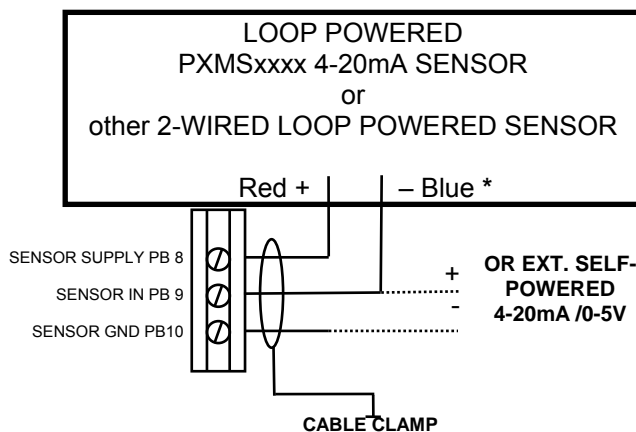

The pressure/temperature cabling must be overall screened PVC insulated minimum 24 AWG (7/0.2mm) (number of conductors (cores) as required by the relevant sensor). Since this cable may be run in conduit with high voltage wiring, its voltage rating must exceed the maximum voltage carried by any other cable connected to the control or run in the same conduit.

The input is suitable for use with 0-5V or 4-20mA signals (externally or internally powered). Refer to section 2.5.3 for details on setting the option links for the correct voltage and input type.

*** NOTE: Do NOT use the Black wire of the PXMS Sensor**

Incorrect connection may damage or destroy the units being connected.

WARNING

Do not wire the Sensor “live” with power on. With JPI in the “IN” position a 220 ohm resistor is put across terminals PB9 and PB10. Shorting or miss-wiring these terminals may damage this resistor. Should the resistor become open, an external 220 ohm +/- 1% ½ watt resistor may be installed across terminals PB9 and PB10.

2.6.17 Remote Setpoint (Analog Input 5) (PPC6000)

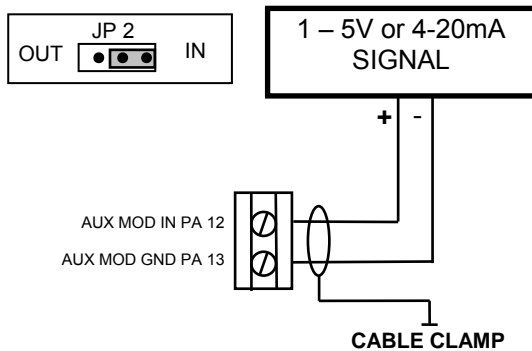

The auxiliary modulation input cabling must be overall screened PVC insulated minimum 24 AWG (7/0.2mm) (number of cores as required by the relevant sensor). Since this cable may be run in conduit with high voltage wiring, it's voltage rating must exceed the maximum voltage carried by any other cable connected to the control or run in the same conduit. Ensure link JP2 is set to the 'IN' position if the input is being connected to a device with a 4-20mA output.

Incorrect connection may damage or destroy the units being connected.

2.6.18 RS485 interface (PPC6000)

The RS485 interface included in the basic control is intended to be used for interconnection of several Fireye units or connection of a 'lap-top' computer during commissioning if it is intended to make a permanent connection to a PC or non-Fireye equipment the optional isolated RS485 daughter board should be installed. The RS485 cabling **MUST** be overall braided shielded (screened) 3-core PVC insulated 24 AWG (7/0.2mm). Since this cable may be run adjacent to, and/or in the same conduit as high voltage wiring, its voltage rating must exceed the maximum voltage carried by any other cable connected to the control or run in the same conduit.

Terminate the screen **at each control** using the cable clamps provided. **Incorrect connection or application of excess voltage may damage or destroy the units being connected.**

Sequencing

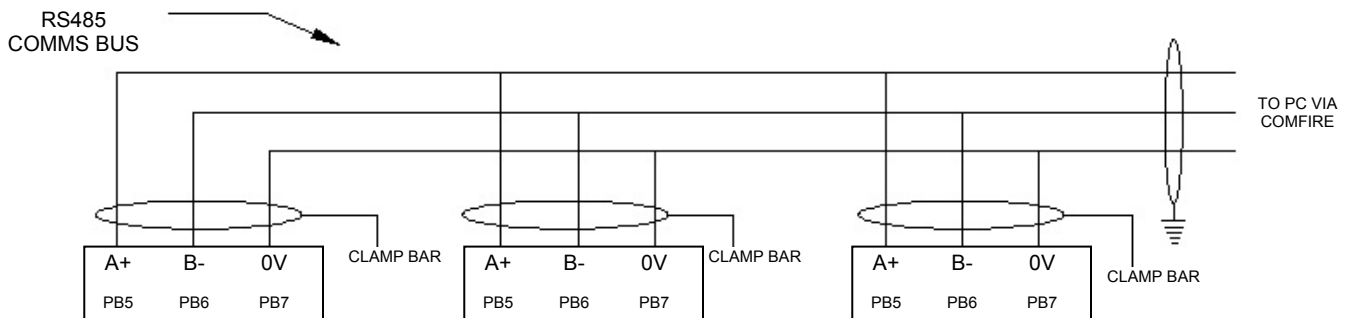

Building Automation

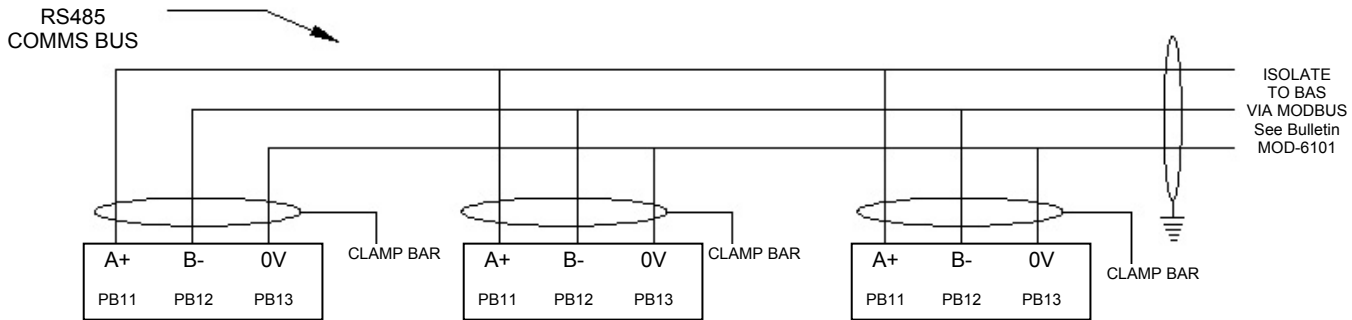

NOTE: Due to differences in communications hardware, it may be necessary to reverse the “A” and “B” wires.

RS485 A (+) PB 5	
RS485 B (-) PB 6	
RS 485 GND PB 7	
RS 485 ISOL A (+) PB 11	
RS485 ISOL B (-) PB 12	
RS485 ISOL GND PB 13	

For details on connecting PPC6000 series controls to a PC on the communications bus, refer to the manual NX-1502 (Comfire2 combustion analysis tool).

NOTE: Isolated RS485 (PB11 thru PB13) for use with Modbus / BAS integration – Requires optional Daughter Board. See MOD-6101 for details.

NOTE: Interposing terminal blocks should be avoided when shielded cable is required. Interposing terminals present a risk of electrical noise interference resulting in unreliable operation.

2.6.19 Variable Speed Drive Selection:

The NX6100 may have an optional daughter board within the main enclosure to allow control of 1 or 2 inverter drives. Optionally the daughter board is also available to allow feedback to be taken directly from encoders measuring the speed of the relevant motor, fan or pump shaft. There is also an option to allow the cup speed of an additional rotary device, e.g. atomizing cup, to be monitored as an encoder input.

When not configured to control an inverter, the 4-20mA outputs may be configured to transmit system variables as current outputs (4-20mA) such as modulation rate, steam pressure, etc.

There are special wiring requirements for inverter feedback. See Caution in Section 2.6.20.

Important note: When selecting a VSD or variable frequency drive (VFD) consideration must be given to the size and weight of the blower wheel. While a “fan” application is by nature a variable torque load, the inertia (weight) of the blower wheel must be considered. Typical HVAC type drives do not speed up or slow down large blower wheels with enough control to operate within the tolerance of the PPC or NX series control. Therefore, a VSD (VFD) with some built in breaking capability, such as a constant torque drive, should be used. At a minimum, if the drive has a constant torque setting, it must be enabled to minimize faults due to drive hunting. Since VFD’s are expected to perform as if they are servomotors, similar positional errors are applied to VFD’s. See Section 7.

2.6.20 PPC6000 Variable Speed Drive Daughter Board P/N NXDBVSD

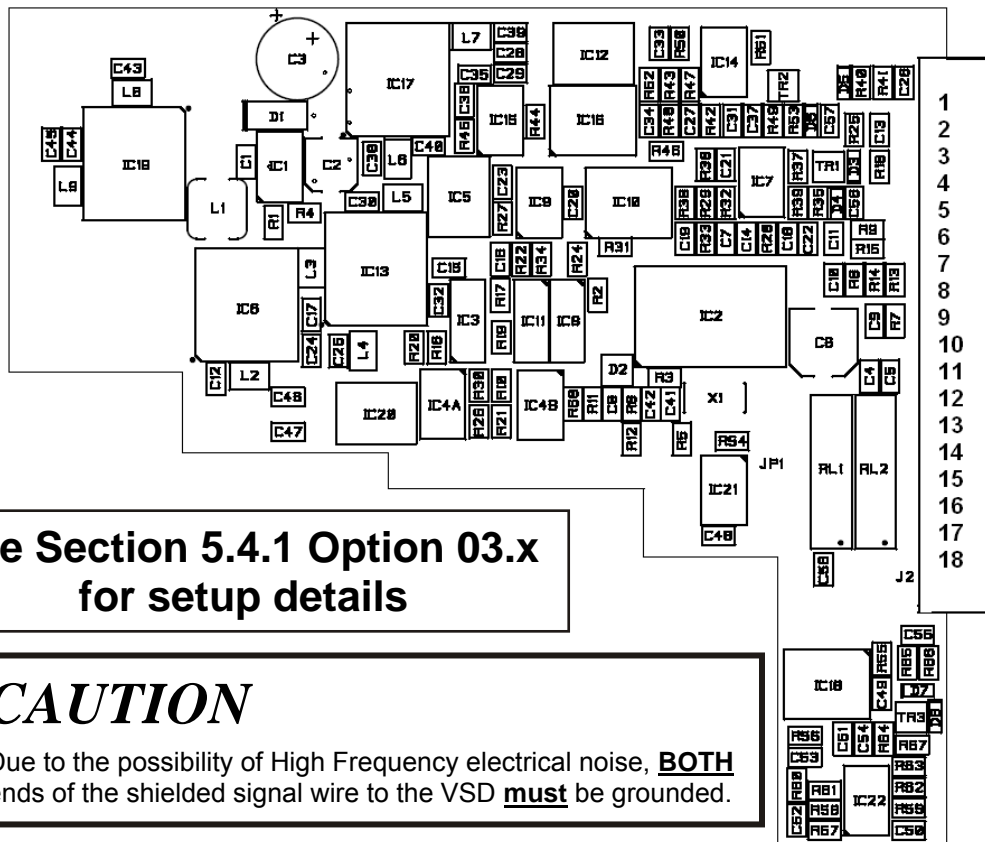

See Section 5.4.1 Option 03.x
for setup details



CAUTION

Due to the possibility of High Frequency electrical noise, **BOTH** ends of the shielded signal wire to the VSD **must** be grounded.

- 4-20mA Output Channel 1 - PZ 1
- 4-20mA Output Channel 1 + PZ 2
- 4-20mA Output Channel 2 - PZ 3
- 4-20mA Output Channel 2 + PZ 4
- 4-20mA Output Channel 3 - PZ 5
- 4-20mA Output Channel 3 + PZ 6
- Counter Input 1 PZ 7
- +12Vdc PZ 8
- Counter Input 2 PZ 9
- +12Vdc PZ 10
- Counter Input 3 PZ 11
- Input Channel 1 - PZ 12
- Input Channel 1 ± PZ 13
- Input Channel 2 + PZ 14
- Relay 7 common PZ 15
- Relay 7 normally open PZ 16
- Relay 8 common PZ 17
- Relay 8 normally open PZ 18

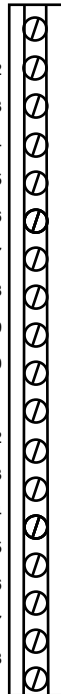

The cabling for all of these terminals must be 2-conductor (core) overall screened PVC insulated 24 AWG (7/0.2mm). Since this cable may be run in conduit with high voltage wiring, it's voltage rating must exceed the maximum voltage carried by any other cable connected to the control or run in the same conduit.

The counter inputs are for use with encoder(s) for speed feedback from the devices being controller by the inverter(s) connected to the 4-20mA output(s) on this daughter board.

The analog outputs are isolated but the analog inputs are not and therefore special precautions must be taken when using these inputs.

The inputs are for 4-20mA signals **must** be isolated as the second input connects 'on-top' of the first to ensure 'cross-talks' will be detected. Terminal PX13 alternates ± to be shared with PZ12 and PZ14. This "switching" detects a direct link between input 1 and input 2 which is not allowed.

The function of relay 1 & 2 can be set by option parameter, but please note the maximum rating of these relays is 200mA at 50V.

Incorrect connection may damage or destroy the units being connected.

2.6.21 LIVE and NEUTRAL supply (optional Oxygen Probe Interface unit)



WARNING

Incorrect setting of the Supply Voltage Links **WILL** damage or destroy the unit.

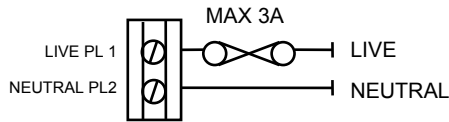

The LIVE and NEUTRAL supplies must be connected using multi-strand single conductor (core) PVC insulated 16 AWG (19/0.3mm) wire. The live connection should be fused with a maximum rating of 3A.

2.6.22 Oxygen probe connection (optional Oxygen Probe Interface unit), NX02INT

Bussman S504 series

PN GMA-5

5 AMP (Fast Acting)

(to protects transformer primary DC circuit)

Alternate Source:

Mouser Electronics : PN 504-GMA-5

PM 9 - PROBE HEATER >24VAC
 PM 8 - PROBE HEATER >24VAC
 PM 7 - FLUE TEMP. THERMOCOUPLE +
 PM 6 - FLUE TEMP. THERMOCOUPLE -
 PM 5 - CELL TEMP. +
 PM 4 - CELL TEMP. -
 PM 3 - CELL OUTPUT +
 PM 2 - CELL OUTPUT -

Bussmann - S504 series

P/N GMD-630 (TIME Delay) for 115V

P/N GMD-315 (TIME Delay) for 230V

(to protect 24V circuit

Alternate Source::

Mouser Electronics

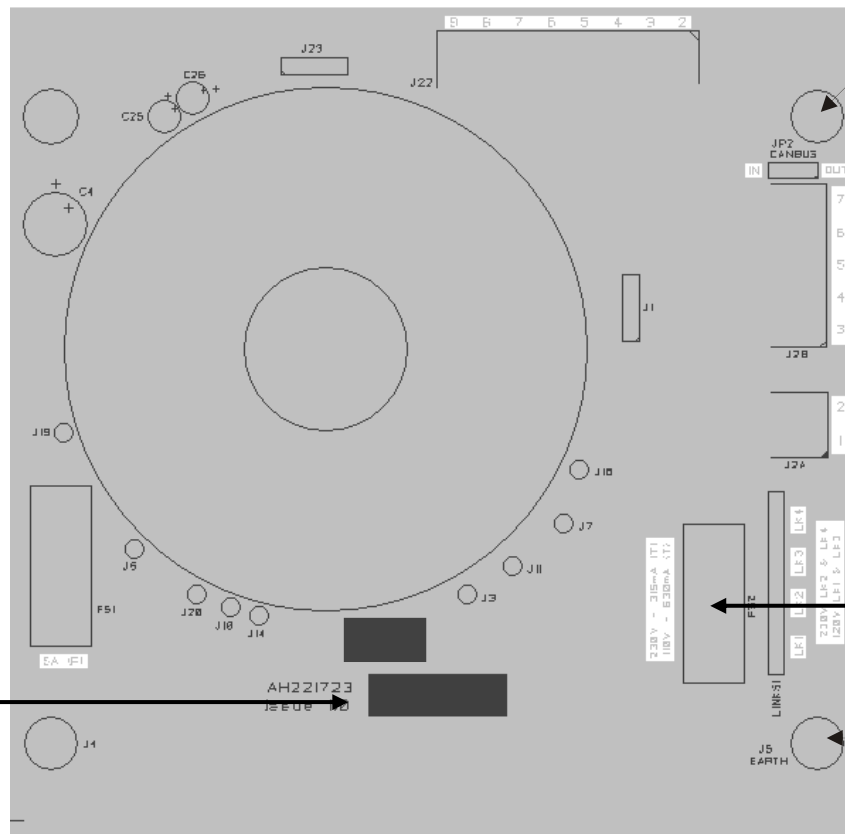

Termination for screens from Oxygen Probe (screw)

PL 7 0v Common (-) see note
 PL 6 I/P 2 4 + 20mA (+) see note
 PL 5 N/A future use
 PL 4 CANbus -
 PL 3 CANbus +

PL 2 Neutral
 PL 1 Live

Ground (Earth) (screw)

NOTE: 4-20mA O₂ input from non-Fireye O₂ probe. See sections 30.1 and 30.2



CAUTION

- Disconnect the power supply before beginning installation to prevent electrical shock, equipment and/or control damage. More than one power disconnect may be involved.
- Wiring must comply with all applicable codes, ordinances and regulations.
- Wiring where required, must comply with NEC Class 1 (Line Voltage) wiring.

The cabling between the unit and the probe consists of the following:

Cable	Specification
Probe heater cable	<ul style="list-style-type: none">• Max. voltage in use <30V ac• Overall braid screened 2-core PVC insulated 16 AWG (19/0.3mm) (300V 176°F (80°C)).• Max. cable length 20 meters between units.
Probe cell signal cable	<ul style="list-style-type: none">• Max. voltage in use < 15V dc• Overall braid screened 2-core PVC insulated 20AWG – 16/0.2mm (300V 176°F (80°C)).• Max. cable length 20 meters between units.
Heater and flue thermocouple compensation cable	<ul style="list-style-type: none">• Max. voltage in use <15V dc• Cable Colors:<ul style="list-style-type: none">◆ EU -- 2 PVC insulated cores, green (+ve) and white (-ve) covered by a green PVC sheath.◆ US -- 2 PVC insulated cores, yellow (+ve) and red (-ve) covered by a yellow PVC sheath.• Each core consists of 24AWG – 7/32AWG (300V 80°C) solid conductors covered by PVC insulation. (EU cable may be stranded wire.)• Type K compensating cable

NOTE: Thermocouple wires are polarized. Failure to connect the correct color to the designated terminal will result in a temperature offset that will affect the operation. CHECK TWICE to be certain.

Oxygen Probe Wiring

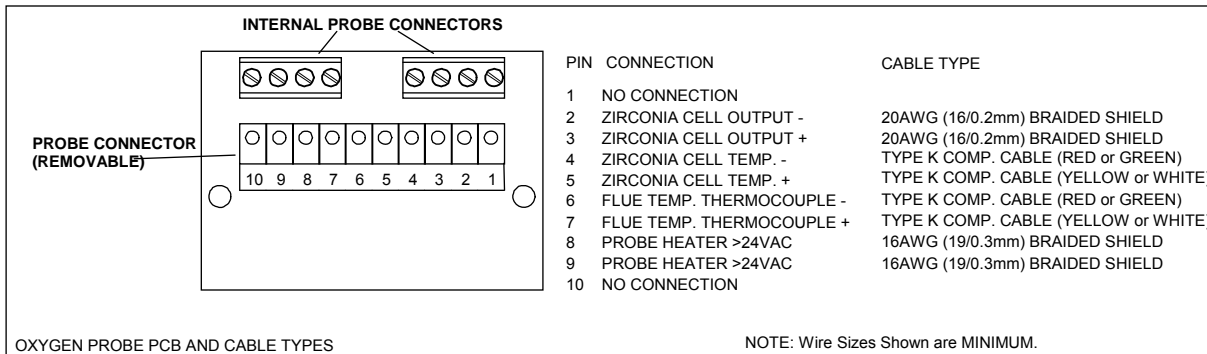
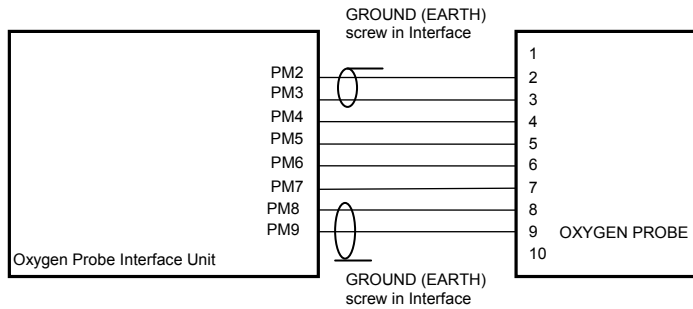

After ensuring all connectors are correctly fitted, secure the probe cap on the probe. The heater supply must be connected using screened 2 conductor (core) 16 AWG (19/0.3mm) PVC insulated cable. The oxygen cell output must be connected using screened 2 conductor (core) 20 AWG (16/0.2mm) PVC insulated cable. Both thermocouple connections must be made using type K compensating cable. **For screen connection detail refer to section 2.6.2. DO NOT connect the screens at the probe.**

Incorrect connection may damage or destroy the units being connected.

2.6.23 Inlet temperature sensor (optional)

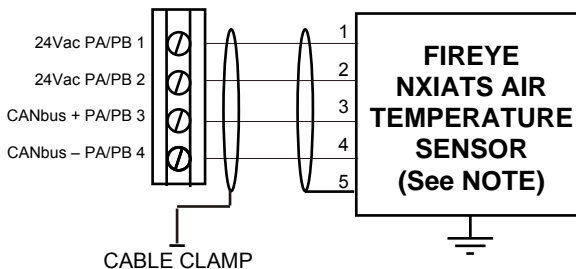

NOTE: Insulate Shield (Terminal 5) to prevent accidental shorting to pins on circuit board (J1)

The system allows direct connection of an FIREYE inlet temperature sensor. The unit is connected via CANbus similar to the servo-motors and display, using overall screened 4 conductor (core) 24 AWG (7/0.2mm) PVC insulated cable. Since this cable is to be run adjacent to, and/or in the same conduit as high voltage wiring, its voltage rating must exceed the maximum voltage carried by any other cable connected to the control or run in the same conduit. **See Sections 2.6.1 & 2.6.2.**

Incorrect connection may damage or destroy the units being connected.

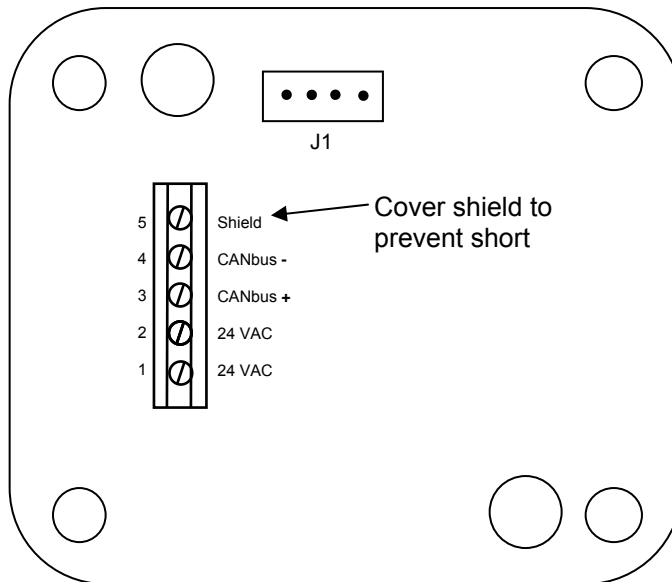

NOTE: Insulate Shield (Terminal 5) to prevent accidental shorting to pins on circuit board (J1)

NXIATS
Inlet Air Temperature Sensor

2.7 Final checks



WARNING

Incorrect setting of the Supply Voltage Links **WILL** damage or destroy the unit.

Before applying power, make the following checks:

- The control(s) supply voltage is correctly set, incorrect setting **will** destroy the unit(s).
- All other jumper (link) positions are correct.
- The fuse(s) are of the correct type and value, incorrect type or value may damage or destroy the units.
- All wiring and connections have been made according to the specifications detailed in this chapter.
- Before applying power to the control ensure that the probe heater output is not attempting to drive into a short circuit by checking between terminals PM8 and PM9 using a resistance meter. The expected resistance with an oxygen probe fitted should be greater than 15ohms.
- Enclosure lid(s) are fitted before applying power to the control(s).

3 Servo-motor selection and calibration



CAUTION

- All servo-motors connected to the PPC6000 control system **must** be approved as part of system.
- The total electrical load for all connected servo-motors **must not** exceed 40VA.
- Valve and motor alignment and calibration **must** be set in commission ratio mode prior to commissioning any profile setpoints.

3.1 Servo-motor selection

3.1.1 Motor requirements

Only servo-motors supplied by FIREYE may be used with this equipment, various servo-motors are available, to suit differing applications. The information below is intended as a general guide only; ensure that when installing or adjusting the servo-motors fitted to the appliance that reference is made to the correct instruction manual.

- All servo-motors must be connected via CANbus, no other possibility exists.
- All 24V servo-motors operate at 24Vac and are supplied from the PPC6000 (main) unit.
- All have a 90° maximum movement with an operating time of approximately 30 seconds for 90° travel.
- All have internal limit switches, which must be adjusted during commissioning to allow the close position check to be performed and to protect the burner/boiler against damage should a failure of the electronics occur. **NOTE: Any profile must NOT exceed 40VA.**

PPC6000 Servomotor Guide

Model	Rating FT/LB (Nm)	Voltage	VA
NXC04	3.0 (4Nm)	24	3
NXC12	8.75 (12Nm)	24	5
NXC20, NXC20A	15.0 (20Nm)	24	10
NXC40A	29.0 (40Nm)	24	18

Table: 3.1.1-A

Example: The profile requires 1 NXC20 / NXC20A, 1 NXC40, 2 NXC04

Motor	VA
NXC04	6
NXC20 / NXC20A	10
NXC40	18
Total	34

3.2 IMPORTANT: Servo-motor direction *warning*

It is necessary to ensure that each motor travels in the correct direction to match the mechanical configuration of the burner. The default setting is for a servo to move counter-clockwise (looking at the output shaft) as the motor is driven 'UP'. Option parameters 5.0 to 5.9 can be used to reverse this.

Servo-motors are shipped with the shaft flat in the 9-12 o'clock (facing motor shaft) position and by default rotate counter (anti) clockwise. For applications requiring clockwise rotation the motor must be left disconnected from the device being driven until after the system is powered and the motor set for clockwise direction via **Option Parameter 5.x**. Setting this option to "1" causes the motor to display the maximum travel degree (e.g. 90.0) as set by the internal adjustable end switch. After selecting all motors that are to travel in a clockwise direction, switch to the "adjust motors" display by pressing the "Mode" key. It is now possible to manually drive each of the clockwise motors to the new "P0" position (e.g. 1.0) as set by the adjustable end switch. The flat (facing the shaft) will now be in the 6-9 O'clock position. At this point the mechanical connection to the driven device can be made up. Fireeye "D" hole couplings should be used in order to assure a secure connection. Set screws alone are not recommended as they can come loose resulting in a potentially unsafe condition. Motor shafts are hardened generally preventing set screws from "biting" in and thus loosening after commissioning. Fireeye bulletin NEXBK-1000 provides information on "D" hole couplings. **Setting the option with the motor connected to the device being driven may cause damage to the device or motor.**

Note: The motor shaft, when directly coupled, will rotate in the opposite direction from the driven shaft. For example, if the gas valve rotates counter clockwise to open, then the servomotor **MUST be set to clockwise rotation in Option 5.x**

Shaft Positions as viewed from Shaft End
For NXC04, NXC12, NXC20, NXC20A, NXC40 ONLY

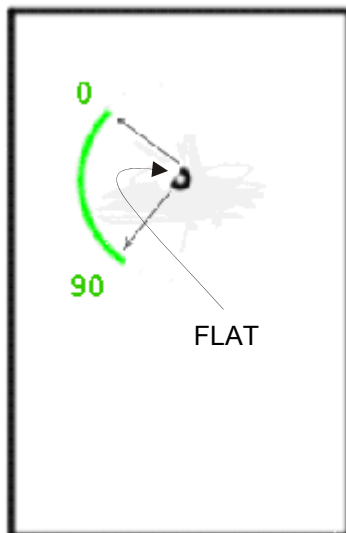

P0
Option Parameter 5.x
Set to 0

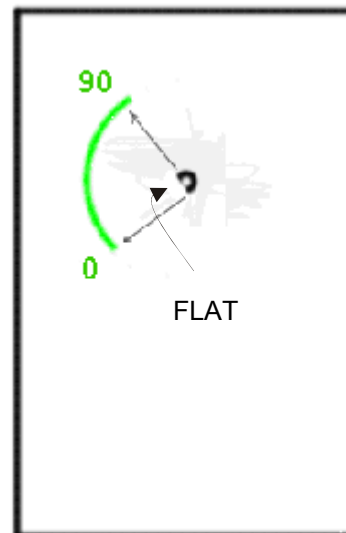

P0
Option Parameter 5.x
Set to 1

Servomotor Shaft Position Warning:

It is not possible to reposition the shaft of the servomotor other than to the factory settings of either clockwise or counter clockwise. That is, the shaft flat (as viewed from the shaft end) will either be in the 9-12 o'clock or 6-9 o'clock position at PO (burner off). Using the "out of the box" settings will make future replacement of servomotors easier. See previous page.

Some motors have a clutch release to allow for the driven device to be rotated for inspection after commissioning. It must be noted that releasing the clutch while the motor is powered will cause the servomotor to drive back to the commissioned P0 position. Power should be removed if the clutch is used for this purpose.

3.3 Locking the servo-motor to the valve shaft



WARNING

- Once the position of the servo-motor shaft relative to the valve shaft is correct, each motor **must** be locked to its valve shaft, for all air damper(s) and fuel valve(s).
- In order to prevent the joint between motor and shaft moving, it is recommended that the device used to link the two items is pinned together.
- It is essential that the motor and valve remain securely connected to ensure safe operation of the equipment, since feedback is only taken from the servomotor.
- Servomotor shafts are hardened; set screws alone are **NOT** sufficient to guard against slippage.

A variety of "D" hole couplings are available. Contact your Fireeye Distributor, or Fireeye, Inc., for assistance.

3.4 Feedback potentiometer



WARNING

- The servo-motor internal feedback potentiometer must be secured within the servo-motor to ensure that there is no possibility that the potentiometer can become disconnected from the motor output shaft.
- For direct drive servo-motor potentiometers (NXC40 only) ensure the potentiometer body is secured to the flexible mounting to prevent any movement between output shaft and potentiometer. Do not adjust the 'nuts' retaining the flexible mounting to the metalwork.
- For gear driven servo-motor potentiometers (4Nm, NXC04, NXC12, NXC20, NXC20A servo-motor) ensure the potentiometer is secured to its mounting bracket and that the bracket is correctly attached to the servo-motor body to prevent any backlash between the potentiometer and the output shaft. **DO NOT**

For each motor, it is necessary to adjust the servo-motor position relative to the shaft it is driving (e.g. gas valve) in order to obtain the correct open and closed positions on the display.

To do this, follow the procedure below:

1. **Ensure that the correct servo-motor direction is set before connecting the servo-motor to the relevant valve.** If the servo-motor direction is incorrect use the relevant option parameter to reverse.
2. Move the valve to its fully closed position and adjust the servo-motor position by driving the motor so that approximately 1° is shown on the display.
3. Move the valve to its fully open position by driving the servo-motor and check that the display reads approximately 90° or the maximum angular opening required from the servo-motor if this is less than 90°.

3.5 Adjusting microswitch positions

Each time a burner start-up sequence is initiated, the control will move the fuel and air damper motors to their respective closed positions to prove correct motor and potentiometer operation. Each motor has microswitches fitted to set the close position obtainable during this proving operation, and limit the maximum 'open' position to prevent burner/boiler damage in the event of a system failure.

To set the microswitch positions, follow the procedure below.

1. Enter commission ratio mode (see section 5)
2. Move each motor to approximately 45°, using the **UP/DOWN** keys, this is to ensure the **DOWN** key will drive the motor.
3. Holding the **DOWN** key, tighten up the low limit microswitch until the motor will no longer move down.
4. Holding the **DOWN** key, gradually slacken off the low limit microswitch until the motor starts moving down. Continue to slacken off the microswitch until the motor stops with a reading on the display of approximately 1°.
5. Move the motor up and down a few times to check that the motor stops each time at approximately 1°, and re-adjust the microswitch if necessary. This position will allow for some tolerance in microswitch operation.
6. Hold the **UP** key and tighten up the high limit microswitch until the motor will no longer move up.
7. Holding the **UP** key, gradually slacken off the high limit microswitch until the motor starts moving up. Continue to slacken off the microswitch until the motor stops in the desired purge position. This position does not have to be 90°, but it is recommended that it is more than 45° and less than 90°.
8. Move the motor, up and down a few times to check that the motor stops each time at the desired 'limit' position. Repeat steps 3 to 7 if necessary.

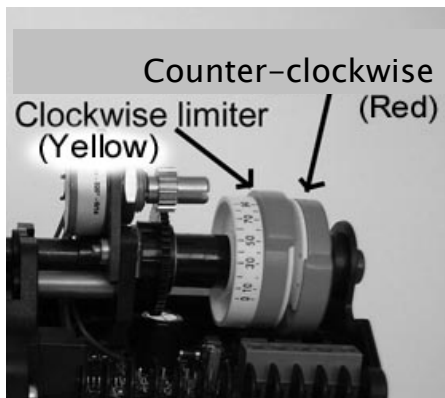

NOTE: For NXC04, NXC12, NXC20, NXC20A SERVOS ONLY

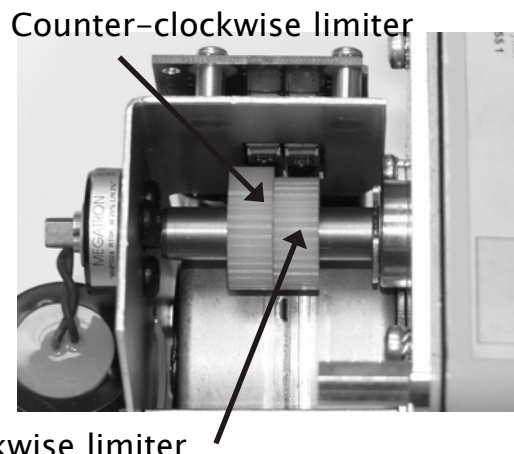

NOTE: For NXC40 SERVO ONLY



3.6 Servomotor Replacement

After a system has been commissioned replacing an undersized or failed servomotor requires the following considerations:

1. First determine the direction the motor travels as the replacement will have to be set the same way. This can be found in Option Parameter 5.x (x being the number of the drive. Eg. 5.3 is drive 3). If the device being driven rotates clockwise to increase firing rate, then the servomotor must drive counter clockwise (as viewed from the servomotor shaft) and vice versa.
2. **DO NOT COUPLE THE MOTOR TO THE DRIVEN SHAFT UNTIL AFTER THE DIRECTION HAS BEEN SET. SEE SECTION 3 OF THIS MANUAL.**
3. Deselect the original servomotor serial number using Option Parameter 3.x.
4. Select the new servomotor serial number from Option 3.x. The serial number appears on the servomotor label but will also appear as "unreserved" in the list.
5. The burner will have to be started in full commissioning mode and each position, P0 though PX (high fire), must be verified by using the "next" key on the display. This is covered in the commissioning section of the manual (Bulletin PPC-6001). Combustion should be checked while doing this so as to assure a safe operation.

4 Description of operation

4.1 The Display / Keypad

The display is a 2 line, 20 character per line, dot matrix vacuum fluorescent type allowing the use of plain text messages for most display parameters. The keypad is a membrane construction with tactile keys to give a positive feedback of the actuation.

NOTE: The display can be attached to more than one PPC6000 via CANbus. The display must be interrogating the address of the desired PPC6000, if not a fault message will be displayed. See the troubleshooting section (Section 6.7.1) for details.

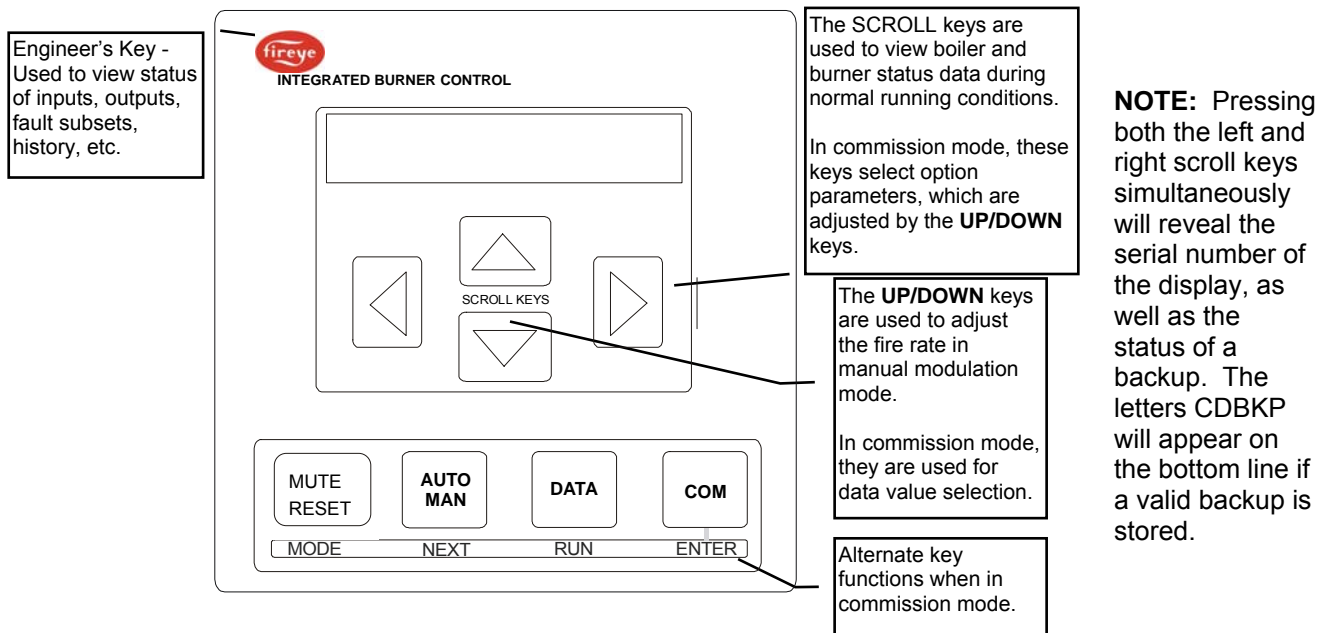

Key	Function
	Selects Engineers Key mode. See section 6.6 for further details.
MUTE/RESET	Press this key to mute (open) the alarm relays, then hold the key down for three seconds to remove any cleared faults.
AUTO MAN	Selects auto or manual burner modulation. In manual mode the UP/DOWN keys are used to alter the firing rate.
DATA	Toggles the display between normal run mode and servo-motor position. In COM missioning mode this key is used to return to run mode. Selects different data types on the display window. Holding the DATA key down for 5 seconds allows for selection of operating modes: NORM = normal / remote, used for sequencing. Loc1 = use PID 1 only Loc2 = use PID 2 only LEAD= Boiler is Lead (upper case) lead = Boiler is not lead (lower case) OFF = Turns burner off
COM	Changes operation to commission mode via a passcode. In COM missioning mode this key is the "enter" key.



4.2 Start-up sequence

This fuel / air ratio control performs burner start-up and shut-down in conjunction with an external 'burner controller'. The external 'burner controller' provides burner management functions such as flame / air pressure monitoring and it also controls the fuel shut-off valves and combustion air fan.

The start-up and shutdown sequence is handled by a progression of stages, each requiring a certain set of conditions to move on to the next one. The progression through the stages requires 'handshaking' between the two devices. This is accomplished with a variety of signals. Relevant Engineers Key, if available, will be shown as (EK#).

From burner controller to fuel-air ratio controller:

Signal Name:	Alternate Names / Pin:	Description:
H (HIGH) (EK5)	Purge request, PA9. Low Voltage	Commands fuel / air ratio controller to move the servos UP for either a pre-purge or a post purge. LOW VOLTAGE. This input is made by connection to PA11. If this input comes on during burner normal run (modulation), the burner will be turned off and a post-purge initiated.
A (AUTO) (EK6)	Release to Modulate, PA10. Low Voltage	Releases the fuel / air ratio controller to modulate as required to support the load on the boiler. LOW VOLTAGE. This input is made by connection to PA11. If this input goes OFF during a normal run, the motors will move to their low-fire (not ignition) positions and stay there. No feedback will be given on LFS (see below). (See OPT 16.1 for return to pilot)
PROFILE SELECT (EK11-14) (EK31)	PE9, PE10, PE11, PE12 Line Voltage	Tells the fuel / air ratio controller which fuel / air profile to run. This signal must be removed when the burner goes off, before a new start-up can begin. It is common to use a selector switch fed from the fan contactor output of the burner controller for this input. LINE VOLTAGE. If this signal is removed at any time, the controlled shutdown output (PE3) will turn off for at least 3 seconds to ensure the burner is off. (See OPT 16.2 for profile swap on the fly.)

From fuel-air ratio controller to burner controller:

Signal Name:	Alternate Names / Pin:	Description:
SAFETY SHUTDOWN	Lockout, PE5 – PE6. Line Voltage	These contacts will open in the event of a lockout of the fuel-air ratio controller. When this happens, PE3 will loose power a short time later. These contacts MUST be in the main safety circuit of the Flame Safeguard, effectively interrupting power to the fuel valves. LINE VOLTAGE. The installation must guarantee that if these contacts open, the burner goes off IMMEDIATELY.
CONTROLLED SHUTDOWN (EK18) (EK30)	Call for heat. PE3. Line Voltage	When the fuel-air ratio controller requires the burner to come on, LINE VOLTAGE will be present on this terminal.



Signal Name:	Alternate Names / Pin:	Description:
HFS (HIGH FIRE SWITCH)	Purge proved, PE8. Line Voltage	When the purge (P1) position is reached (pre-purge or post-purge), LINE VOLTAGE will be present on this terminal. Line voltage will also be present here when the control is modulating and high fire is reached, but only if the AUTO input is ON. (See OPT 16.2 for profile swap on the fly.)
LFS (LOW FIRE SWITCH)	Ignition proved, PE7. Line Voltage	When the ignition (P2) position is reached and the fuel-air ratio controller is ready for ignition, LINE VOLTAGE will be present on this terminal. Line voltage will also be present here when the control is modulating and low fire is reached, but only if the AUTO input is ON. . (See OPT 16.2 for profile swap on the fly.)

The startup / shutdown stages are as follows:

Stage no.	Stage name	Description
0.	Non-volatile lockout / safety shutdown	<p>The burner is held in this state until all faults are removed.</p> <p>The 'safety shutdown' output (PE5 – PE6) will be open. The 'controlled shutdown' output on PE3 will also be OFF during this time, however if the burner was running when the fault occurred, the 'safety shutdown' output will have opened first.</p>
1.	Burner off (EK18)	<p>The burner is checked to make sure that it has switched off completely. The fuel/profile select inputs must all go OFF when the burner is switched off (or at the end of post-purge). This provides a feedback to confirm that the burner is off, and ensures that this control is always synchronized with the burner controller.</p> <p>The 'controlled shutdown' output on PE3 will be OFF during this time, however the 'safety shutdown' output PE5 – PE6 will be closed during this time.</p> <p>The control will advance to status 2 when:</p> <ul style="list-style-type: none"> - All fuel/profile select inputs are OFF - The 'boiler status' is equal to 1 (call for heat). See engineers key 18. - The 'AUTO' input (PA10 – PA11) is OFF (open).



Stage no.	Stage name	Description
2.	Wait for purge (EK5) (EK11-14) (EK31)	<p>The 'controlled shutdown' output on PE3 will be switched on, to tell the burner controller there is a call for heat.</p> <p>This control waits for a fuel/profile select signal on one of the (line voltage) terminals PE9, PE10, PE11 or PE12 and a purge request (HIGH input, PA9 - PA11 closed. This input is low voltage). This would normally come from the burner controller.</p> <p>If the fuel/profile select input is removed (PE9, 10, 11 or 12), the control will immediately move to status 1.</p> <p>Note: Statuses 3 and 4 are reserved for a gas valve proving system and are not implemented on this control. This control will advance directly to status 5 once the conditions above have been met.</p>
3. & 4.	N/A	Not Applicable to PPC6000
5.	Prove closed positions (EK80-89)	<p>In all profiles, the fuel and air motors are moved down until they are stopped by the 'closed position' micro-switches in the servos. The final positions are compared with the closed positions stored in memory, and must be within $\pm 5^\circ$ of the stored values otherwise the control will lockout.</p> <p>Variable speed drives must read zero. (4 mA). This includes any VSD (VFD) assigned to the chosen profile.</p> <p>When all drives have stopped moving, the control will advance to status 7. The 'HIGH' input (PA9 to PA11) still must be made during this time.</p> <p>If the fuel/profile select input is removed (PE9, 10, 11 or 12), the control will immediately move to status 1.</p> <p>Note: Status 6 is reserved for air pressure detection, and is not implemented in this control. This function must be provided by the burner controller.</p>
6.	N/A	Not Applicable to PPC6000
7.	Moving to Purge	<p>The selected motors are moved up towards the purge position. When the drives have all stopped, the control moves to status 8.</p> <p>If the fuel/profile select input is removed (PE9, 10, 11 or 12), the control will immediately move to status 1.</p>



Stage no.	Stage name	Description
8.	Pre-purge	<p>The controller confirms all required drives are at their purge positions, and gives a 'purge proved' signal by providing (line voltage) to terminal PE8 (high-fire-switch).</p> <p>The control will remain in this status until the burner controller signals the end of pre-purge by breaking PA11 – PA9 ('HIGH' input).</p> <p>If the fuel/profile select input is removed (PE9, 10, 11 or 12), the control will immediately move to status 1.</p>
9.	Move to ignition positions	<p>The selected motors are moved to their ignition positions. The 'purge proved' signal is switched off. When the drives have all stopped moving, the control advances to status 10.</p> <p>If the fuel/profile select input is removed (PE9, 10, 11 or 12), the control will immediately move to status 1.</p>
10.	Ignition	<p>The controller confirms all required drives are at their ignition positions, and gives an 'ignition proved' signal by supplying line voltage to terminal PE7 (low-fire-switch).</p> <p>The controller will hold the drives at their respective ignition positions until the signal to modulate is received from the burner controller. This is performed by closing the circuit on PA10 – PA11 (AUTO input).</p> <p>If the fuel/profile select input is removed (PE9, 10, 11 or 12), the control will immediately move to status 1.</p>
11-14	N/A	<p>NOTE: Statuses 11 to 14 control the light-up sequence of the burner and are provided by the 'burner controller' device used for the application. This control will jump from status 10 to status 15 when the light up is completed.</p> <p>Not Applicable to PPC6000</p>



Stage no.	Stage name	Description
15.	Moving to low fire	<p>Once the AUTO signal is received the fuel and air motors are moved from their ignition positions to their low fire positions. These positions may or may not be the same as the ignition positions. The 'ignition prove' terminal PE7 (low-fire-switch) is switched off.</p> <p>If the fuel/profile select input is removed (PE9, 10, 11 or 12), the control will immediately move to status 1.</p> <p>Once the drives have reached their low fire positions, and an AUTO signal is received (PA10 - PA11), the control will advance to status 16.</p> <p>IF Option 23.0 (warming limit) is enabled, drive will remain at low fire until time set by Option 23.0 expires.</p> <p>NOTE: terminal PE7 will always be OFF during status 15.</p>
16.	Modulation (EK33)	<p>Once the fuel and air motors reach their low fire positions, they are modulated according to the demand placed on the burner.</p> <p>In this burner status the 'high-fire-switch' and 'low-fire-switch' outputs (PE8 & PE7) will come on at high and low fire respectively and may be used for indication purposes.</p> <p>If a 'HIGH' input is provided by closing PA9 – PA11, this control will move to status 17.</p> <p>If the 'AUTO' input is removed by opening PA10 – PA11, this control will modulate down to low fire then jump to status 15. Note: Terminal PE7 will not be energized in this case. This may be used to provide a low fire post purge, or a low fire hold function.</p> <p>If the fuel/profile select input is removed (PE9, 10, 11 or 12), the control will immediately move to status 1.</p> <p>If this control wishes to turn the burner off (there is no call for heat, for example), it will open the 'controlled shutdown' relay, removing power from PE3. It will remain in modulation status however, until one of the conditions above is met.</p>
17.	Move to post-purge	<p>The selected motor(s) are moved to their purge positions all others are moved to their closed positions. When the drives have all stopped, the control will move to status 18.</p>



Stage no.	Stage name	Description
18.	Post-purge	<p>The controller confirms all required drives are at their purge positions, and gives a 'purge proved' signal by providing (line voltage) to terminal PE8 (high-fire-switch).</p> <p>The control will remain in this status until the burner controller signals the end of pre-purge by breaking PA9 – PA11 ('HIGH' input), or the fuel/profile select input is removed (PE9, 10, 11 or 12). In either case, the control will immediately move to status 1.</p>

4.3 Non-volatile lockout

Non Volatile lockouts cannot be cleared without operator intervention and are remembered in the event of power being removed from the control.

A non-volatile lockout will occur under the following conditions:

- In any stage the interface signals are incorrect.
- In stages 5, 7 and 8, stages 10-16 (inclusive) and stage 18 if a motor is not in the correct position
- In any stage, if an internal or external fault not previously mentioned occurs which may affect the safe operation of the burner (see section 0)

4.4 Modulation

During stage 16 (modulation), the control will position the fuel and air motors within the programmed profile appropriate to the requirement for heat. The control has 2 modes of operation using the standard Fireeye PID modulation function, Remote and Local. The mode of operation is set via the keypad by pushing the "Burner ON/OFF" key and selecting the mode. Using the programmable block function (option) within the control it is possible for the modulation control to be generated with alternate options, these are not covered in the standard manual as they may be generated by the user. For an overview of Function Block Programming, see Section 10.

4.4.1 Normal/Remote mode.

In Remote mode, the modulation rate is determined by the internal PID control settings, Manual modulation from the keypad, or by one of the following remote influences:

- Auxiliary modulation input,
- Serial communications.

4.4.2 Local mode. (LOC 1, LOC 2)

In Local mode, the modulation rate is determined by either the internal PID settings or Manual modulation via the UP/DOWN keys. External modulation inputs and setpoint selection inputs are ignored.

When "Local1" is displayed the burner is running using the Setpoint 1 PID settings.

When "Local2" is displayed the burner is running using the Setpoint 2 PID settings.

5 Commissioning the control



WARNING

- This manual may cover more than one model from the PPC6000 series. Check for additional information at the end of this chapter.
- While the control is operating in commissioning mode certain safety checks cannot be performed by the control and therefore the safety of the system operation is the sole responsibility of the commissioning engineer.
- Do not allow fuel to accumulate in the combustion chamber. If fuel is allowed to enter the chamber for longer than a few seconds without igniting, an explosive mixture could result.
- If a flame failure occurs at any point the control will not attempt a re-start until the fault is cleared, unless the option to allow recycling is enabled. Before moving to the ignition position to attempt a re-start the system will perform any selected pre-purge.
- Where operating times are adjustable ensure that those selected are acceptable for the appliance being controlled.
- Ensure that a purge position is entered for each drive as required, failure to enter a purge position will mean all drives remain at their 'closed' positions.
- Once all safety times have been selected it is the responsibility of the commissioning engineer to verify that the times entered are correct for the appliance being controlled.
- After entering and/or adjusting any profile points for any profile it is the responsibility of the commissioning engineer to verify that the resulting fuel air ratio is acceptable for the appliance being controlled.

5.1 General

If any settings in the control are to be changed, it is necessary to enter a commission mode. Three passcodes are available for this purpose.

- *Supplier passcode* - allows entry to all commissioning modes. LV3
- *Adjust Ratio mode*. LV2
- *Site passcode* - allows adjustment of some option parameters. LV1

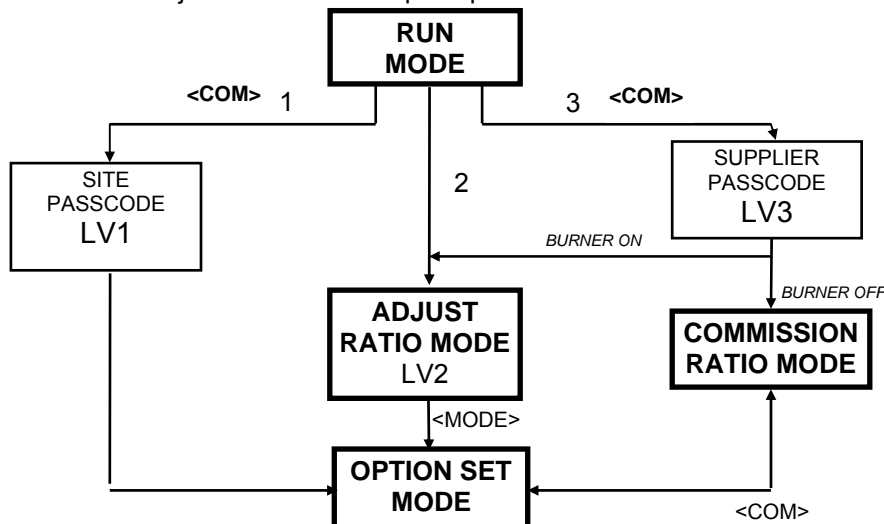

5.2 Commissioning data

5.2.1 Option parameters

The PPC6000 series is configured by programming Option Parameters (memory registers) that describe the configuration of the burner and the boiler. Option parameters are set and adjusted in *Option Set* mode, but it may not be possible to adjust all of them if the burner is on.

5.2.2 Setpoints

Setpoints contain information about required motor positions. There are four profiles (or tables) of setpoints available in a standard control. The profiles may be represented using the diagram below:

Gas position (°)	Air position (°)		Oil position (°)	Air position (°)
2.1	1.9	CLOSE (P0)	1.7	1.9
2.1	88.9	PURGE (P1)	1.7	88.9
24.6	30.6	IGNITION (P2)	10.6	28.7
21.3	25.8	LOW FIRE (P3)	10.6	28.7
76.8	85.6	HIGH FIRE (Px)	50.2	83.5

Up to 24 setpoints may be entered for each profile, including close, purge, and ignition.

New setpoints must be entered in *commission ratio mode*.

Existing setpoints may be modified in *adjust ratio mode* or *commission ratio mode*.

5.3 The Commissioning process

5.3.1 Navigation

The symbols below will be used throughout the Commissioning Process in this manual to indicate the correct application for each commissioning OPTION, for use by the Commissioning Personnel.

A convenient check box has been added to the beginning of the symbols so that the Commissioning Personnel can mark each appropriate option as it is completed.

SYMBOL

MEANS:



Commissioning Personnel **MUST** execute this option

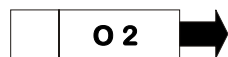

For Customers with **O2 TRIM** option, Commissioning Personnel **MUST ALSO** execute this option



For Customers with **VSD** options, Commissioning Personnel **MUST ALSO** execute this option



After each appropriate option parameter is complete, **CHECK THE BOX!**

There are two (2) types of Displays available for the PPC6000. The first is the standard 12-key keypad shown below and the second is the optional 10.4" touchscreen (NXTSD104) described in section 5.4. Both displays rely on the information in section 4, and the manual reads as though the standard display is being used, so please read the entire section 4 regardless of the type of display in the configuration being used.

5.3.1.1 Entering commission ratio mode

To enter commission ratio mode, turn the burner off. Once the burner has completely shut down, press the key labeled **COM** and select the supplier passcode value using the **UP/DOWN** keys. The supplier passcode is normally two sets of three numbers and is entered as shown below.

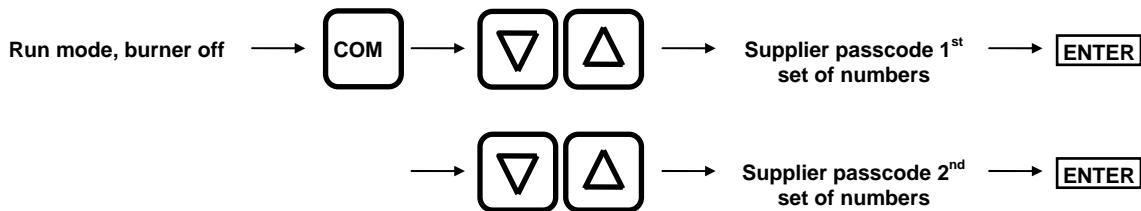

If the entered passcode was correct, 'P 0' will be seen on the display. This represents the closed position setpoint.

5.3.1.2 Changing from Commission / Adjust Ratio mode to Option Set mode

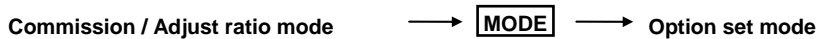

To enter option set mode, enter commission ratio mode or adjust ratio mode (see sections 5.3.1 or 5.4.14 respectively) and press the key labeled **MODE**.

5.3.1.3 Changing from option set to Commission / Adjust ratio modes



5.3.1.4 Exiting from commission mode

To exit from any commission mode to run condition, press the key labeled **RUN** and then **ENTER**.

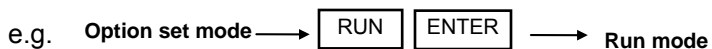

NOTE: Exiting from "full commissioning" mode at P3 or higher will erase any point above the displayed Px. If this is **undesirable**, exit "full commissioning" mode at **HIGH FIRE**.



5.4 Description of Touchscreen operation.

5.4.1 The Touchscreen

The touchscreen provides all of the functions required to control and monitor the burner, it is also used to commission the control.

Once commissioning mode is selected the display background changes to red to alert the user that the control is in commissioning mode and therefore unable to monitor certain safety functions such as fuel air ratio positions.

For a detailed overview of the NXTSD104 – see bulletin NXOGTSD-6101 Operator's Guide.

5.4.2 Touchscreen Power on.

Initialization of the control and display will take approximately 16 seconds, during this initialization period the status LED will remain red. The display backlight will come on and the relays will be held in their no alarm state to avoid the possibility of nuisance alarms, which may otherwise occur.

Five (5) seconds after power is applied the Fireeye splash screen (shown below) will be displayed for 6 seconds, after which a period of 5 seconds of a blank white screen will show.



Once the initialization is complete the touchscreen will show the overview screen (shown in section 5.4.3) and the control will operate normally, changing the LED to green and relays to operate in line with the control status.

5.4.3 The Operation Mode line and Status messages

The line at the top of the screen displays the current burner: operating mode, profile, modulation mode and unit address. Burner status, and fault information, if applicable, is displayed in the bottom right corner of the display.

Dependent on the actual fault the audible alarm may be active and the control may move to safety shutdown.

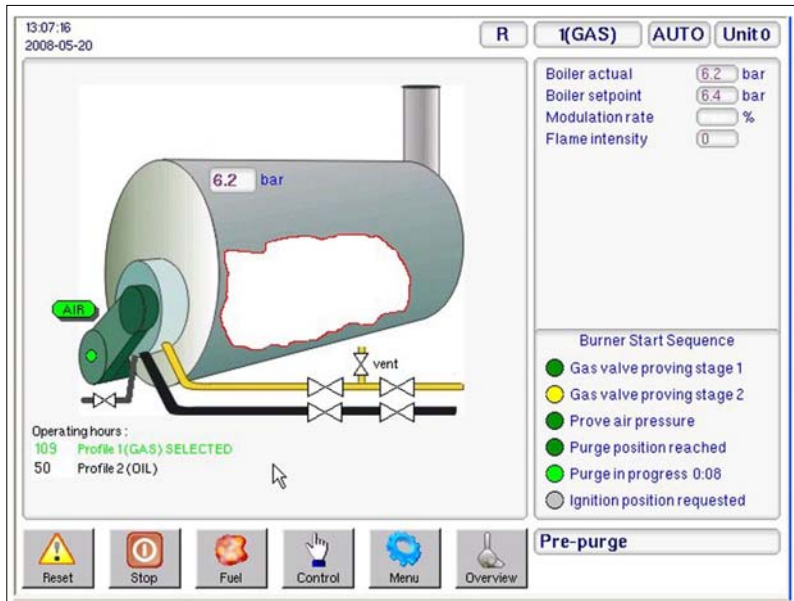

Dedicated 'buttons' at the lower edge of the screen perform the following functions:

Mute / Reset – used to reset a burner lockout, mute alarms or to test audible alarms. If an alarm is present the button is yellow and the text on the 'button' changes to Alarm Mute.

Burner Start/Stop – starts the burner, grayed out if the burner is already operating.

Fuel – allows selection of which fuel/profile is to be used, from a list of fuels/profiles available.

Control – used to enable selection of modulation mode.

Menu – used to access configuration, adjustment modes.

Overview – returns screen to burner overview mode.

The following table shows the icons that are displayed on the touchscreen above the information panels and their details.

Icon	Description	Details
	State of CANbus connection	Displays when CANbus communication is faulty
	State of Oxygen Interface	Displays when Oxygen Interface related fault is present.

Icon	Description	Details
COM	Indicates commissioning mode	Displays when the control is operating in commissioning mode.
MAN	Indicates HAND modulation mode.	Displays when the control is operating in HAND modulation mode.
AUTO	Indicates AUTO modulation mode.	Displays when the control is operating in AUTO modulation mode.
R / L(1) / L(2)	Indicates Boiler Setpoint mode	Displays Boiler setpoint selected, remote, local setpoint 1 or local setpoint 2.
1 / 2 / 3 / 4	Indicates profile selected	Displays the profile number for the selected profile.
13:07:16 2008-05-20	Indicates Time and Date	Displays Actual Time and Date, used for fault history and event logging. Date format is yyyy-mm-dd

5.4.4 Touchscreen Overview display.

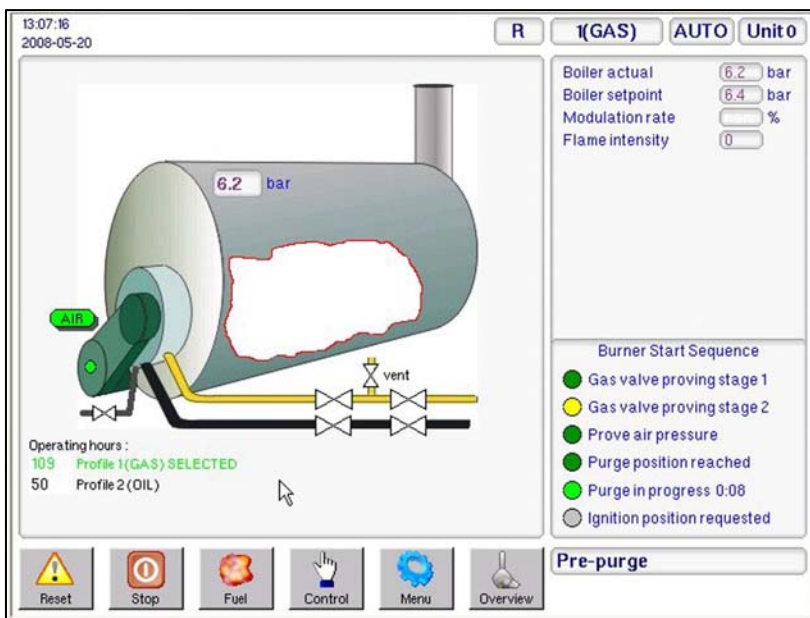

While the burner is changing 'status' the bottom-right one sixth of the display is used to provide a graphical indication of changing status.

The sequences displayed in this manner include, burner start-up, burner shutdown and fuel changeover.

In each case there is a 'lamp' for each stage, providing a ripple through lamp system to clearly indicate the progress of the change in burner 'status'.

The example shown in the picture is for the burner start-up sequence display.

Once the sequence is complete then the display will return, after a short delay, to the overview screen.



5.4.5 Touchscreen Lockout Reset (Alarm Mute) Function.

The **Reset** (Alarm Mute) 'button' on the touchscreen is multi-functional. In normal operation it may be used to test the alarms, this is achieved by holding the button for in excess of 10 seconds after which the alarm relays will activate.

The **Reset** (Alarm Mute) button is also used to mute alarms and reset the control following a safety shutdown. If the alarm is sounding, the button will show the text **Mute**, pressing the button will mute (silence) the alarm, and then the text in the button will change to **Reset**, holding the button for greater than 3 seconds will allow the burner to restart if the faults have cleared. Further details of the functionality of this button are defined below.

There are three types of fault (alarm):

Alarm Only This will allow the burner to continue to operate, while the alarm is sounding.

If the **Reset** (Alarm Mute) button is pressed while the control is in this mode and the alarm is sounding the alarm will be muted and the burner will continue to operate.

Controlled Shutdown This will cause the burner to perform a controlled shutdown, and the alarm will sound, once the fault clears the burner will restart without the requirement for manual intervention.

If the **Mute/ Reset** button is pressed while the control is in this mode the alarm will be muted and the burner will remain in controlled shutdown.

If the **Mute/Reset** button is pressed after the control has restarted following a controlled shutdown the alarm will be muted and the burner will continue to operate.

Safety Shutdown This will cause the burner to perform a safety shutdown, and the alarm will sound, once the fault has cleared the burner will remain in safety shutdown until a **Mute/ Reset** is performed.

If the **Mute/ Reset** button is pressed while the control is in safety shutdown and the fault is still present the alarm will be muted and the burner will remain in safety shutdown. When the fault clears the alarm will sound once more.

If the **Mute/ Reset** button is pressed while the control is in safety shutdown and the fault has cleared the alarm will be muted and if the button is held for in excess of 3 seconds the burner will re-start.

5.4.6 Touchscreen LED Indication.

The Touchscreen also houses a multi-functional LED for indication of current status.

The LED will be green, permanently on, if no faults or limits are present.

The LED will be red, flashing, if there is a limit or an alarm condition present, which does not cause a lockout.

The LED will be red, permanently on, if there is a fault present, even if the fault has been muted, which causes a lockout.

5.4.7 Touchscreen Fuel/Profile Select.

Once the **Fuel** soft-button is pressed, a pop-up window appears on the right giving the user a choice of available fuels/profiles.

The PPC6000 allows for a maximum of four profiles. Any profiles, which are not programmed and therefore not available, will be 'grayed-out'.

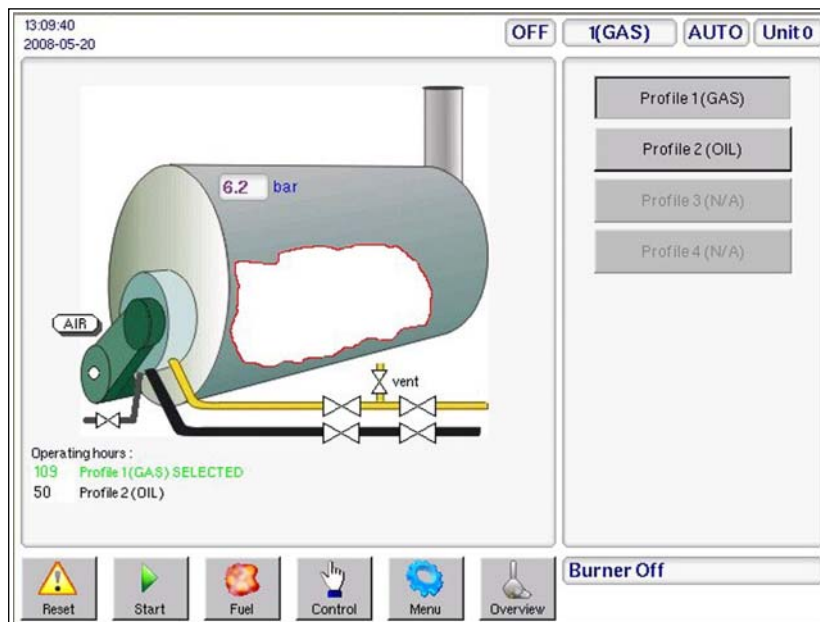

The 'Name' for each available profile will be either the default as set by the relevant option parameter or that entered via the Configuration Screen.

If the profile change is made while the burner is firing, there are two possibilities dependent on the options set in the control.

If the unit does not have the option to perform an online changeover enabled (switch profile without the burner going off) the burner will go through a controlled shutdown on the original profile and then restart on the new profile.

The online changeover allows a digital input to be configured to allow a profile swap without turning the burner off. If this input is ON and a fuel profile selection change is made, the control will go to low fire then back to pilot ignition (P2) on the original profile. It will then drop the main fuel valves and run with just the pilot on (and the ignition transformer if option parameter 14.6 is not set to 1). It will then move all drives to the P2 position of the new profile and open the appropriate main fuel valves.

To exit this operation window and return to the overview screen press the **Overview** button.

5.4.8 Touchscreen 'Control' screen.

Once the **Control** button is pressed, a window appears giving the user a choice of options. If an option is unavailable it will be 'grayed out', for example Manual Modulation may be disabled during commissioning.

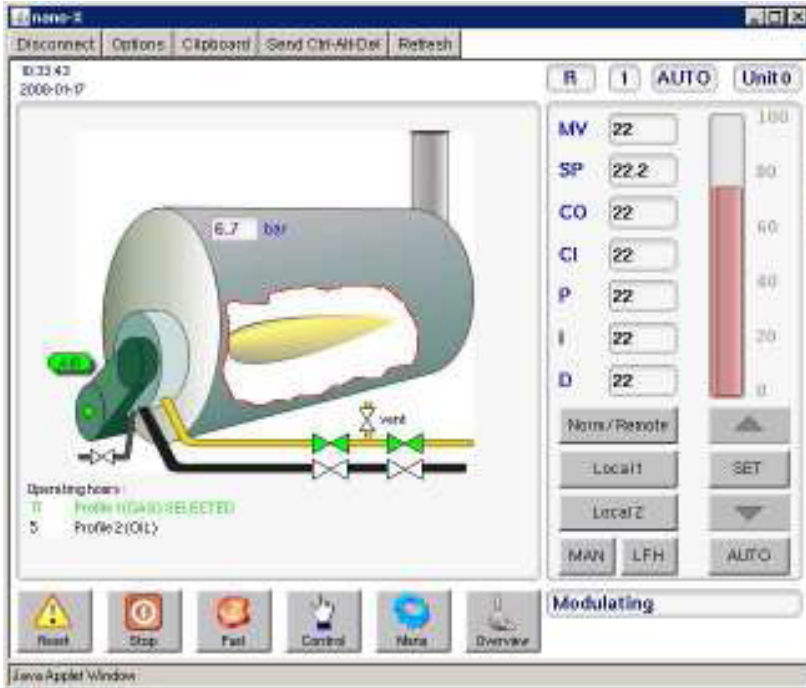

If the burner is firing, then the modulation percentage will be displayed in a window between the 'Burner off' and 'Auto' boxes.

Using the buttons available from this window will change the way the burner is operating.

To exit this control mode window and return to the overview screen use the **Overview** button.

5.4.9 Touchscreen 'Menu' button.

Once the **Menu** button is pressed, a pop-up window appears on the right giving the user a choice of options. If an option is unavailable it will be 'grayed out'.

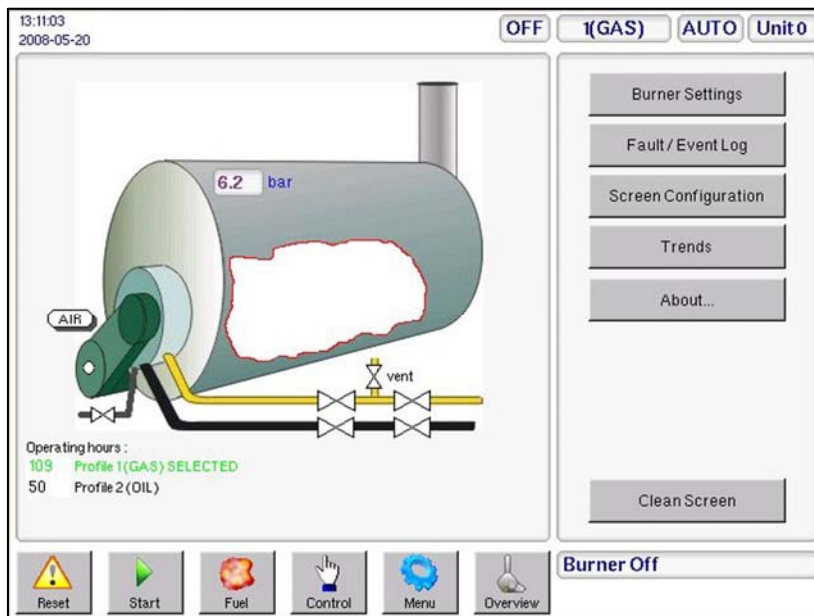

Using the buttons available after pressing the **Menu** button will generate a new pop-up window in the left hand area of the screen.

To exit this operation window and return to the overview screen press the **Overview** button.

5.4.10 Touchscreen 'Burner

Settings' button.

Once the **Burner Settings** button is pressed, a window appears giving the user a choice of data types by Tab. Selecting, by touching a tab, it is possible to view a variety of data, in the example here the Option Parameters are available.

16:45:46
2008-05-20

R (GAS) MAN Unit 0

Burner Settings

Drives Options Engineers Values Pro1 Pro2 Pro3 Pro4

Opt	Value	Description	Set...
21.0	1	PID 1 Enable	
21.1	6.6	PID 1 Setpoint	
21.2	2.4	PID 1 P Band	
21.3	38	PID 1 I-time (seconds)	
21.4	0	PID 1 D-time (seconds)	
21.5	1	PID 1 Limit Type (0 to 2)	
21.6	5.6	PID 1 Low Limit (cut-in)	
21.7	7.2	PID 1 Hi Limit (cut-out)	
21.8	0.0	Remote SP1 (AN5) Zero	
21.9	0.0	Remote SP1 (AN5) Span	

Boiler actual: 6.2 bar
Boiler setpoint: 6.6 bar
Modulation rate: %
Flame intensity: 0

Burner Start Sequence

- Wait for purge
- Open fuel valve
- Gas valve proving stage 1
- Gas valve proving stage 2
- Prove air pressure
- Purge position reached

Change / view parameters. NEXT ENTER COM

Reset Stop Fuel Control Menu Overview

*** LOCKOUT ***
C 14 Air pres. not ON

In the following example the Engineers Key values are displayed. The scroll bar at the side of the data tab allows the user to move up and down the table.

16:48:35
2008-05-20

R (GAS) MAN Unit 0

Burner Settings

Drives Options Engineers Values Pro1 Pro2 Pro3 Pro4

EK	Value	Description
10	0	DigIN10Profile 2(LV)
11	0	DigIN11Profile 4(LV)
12	0	Digital input12 (HV)
13	0	Digital input13 (HV)
14	1	Burner select IN(HV)
15	0	Air flow input
16	0	Low Fire Hold
17	0	Flame detected
18	1	Boiler status (1=go)
19	0	Confirm to adjust

Boiler actual: 6.2 bar
Boiler setpoint: 6.6 bar
Modulation rate: %
Flame intensity: 0

Burner Start Sequence

- Wait for purge
- Open fuel valve
- Gas valve proving stage 1
- Gas valve proving stage 2
- Prove air pressure
- Purge position reached

Change / view parameters. NEXT ENTER COM

Reset Stop Fuel Control Menu Overview

*** LOCKOUT ***
C 14 Air pres. not ON

5.4.11 Touchscreen 'Fault/Event Log' button.

Once the **Fault/Event Log** button is pressed, a window appears showing the Fault/Event history. Users may select to see Fault data only, Events data only or a combined history as shown in this example. For more information on fault codes and fault finding refer to the Fault Finding section of the PPC6000 manual – Fireeye bulletin NEX-6101.



5.4.12 Touchscreen 'Screen Configuration' button.

Once the Screen **Configuration** button is pressed, a window appears giving the user a choice of options. From the General Tab a name may be entered for each profile in use.

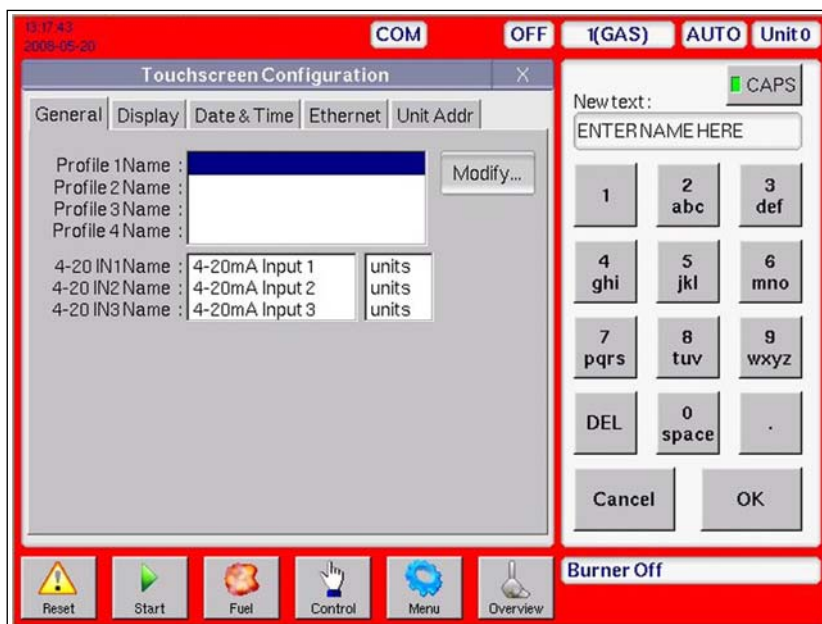

Highlight the profile for which a name is to be entered or modified and press the Modify button. This will cause a window to appear allowing the required name to be entered using the button pad.

Once the name is displayed against the required profile the mode can be exited by pressing the 'X' in the top right corner of the Touchscreen Configuration window.

To exit this configuration window and return to the overview screen press the **Overview** button.

5.4.13 Cleaning the Touchscreen



WARNING

To prevent possible damage to the touchscreen, ensure the correct 'fluid' is used when cleaning the screen.

Before attempting to clean the screen ensure the clean screen function is enabled to ensure operation of the burner is not affected

Once the 'Clean Screen' function is selected the display keys will be unavailable for 20 seconds

Before attempting to clean the screen it is essential to select the **Clean Screen** function to prevent any pressure applied to clean the touchscreen being 'seen' as a 'button press'. The function can be accessed by selecting the **Menu** button at the base of the touchscreen and then, selecting **Clean Screen** from the list of functions available.

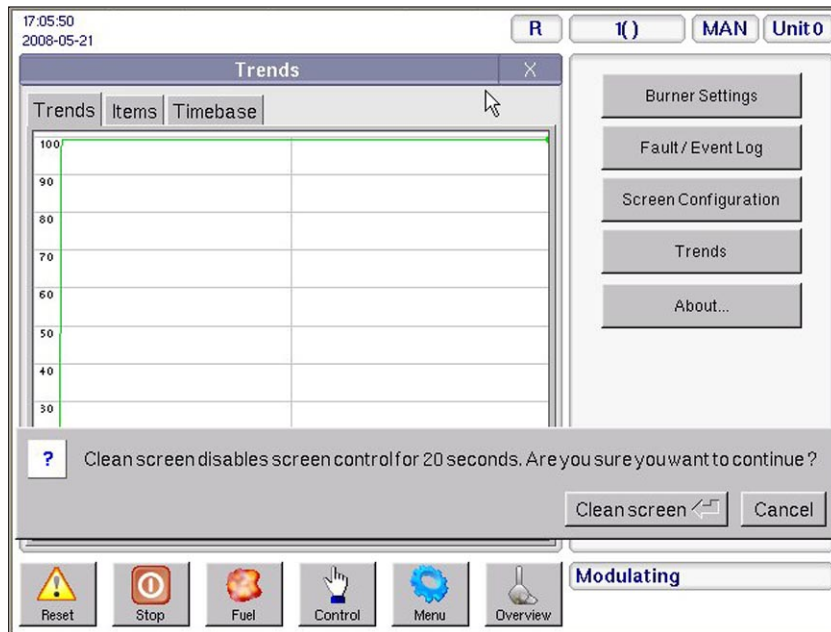

When cleaning the touchscreen ensure the correct LCD screen cleaner is used. Use of any other cleaning fluid or water may damage the screen.

There are designated commercial cleaning solutions on the market for touchscreens only. Also, these products are recommended to be used only with a very soft cloth. Please note the directions and the warnings on the product.



CAUTION

- Do NOT use any ammonia-based window cleaner. These chemical cleaners can ruin the touchscreen surface.
- Do NOT use any abrasive rags, towels or paper towels. An abrasive towel can scratch the touchscreen.

5.4.14 Touchscreen Commission mode.

To allow Option Parameters or Drives to be adjusted it is necessary to enter the relevant access passcode.

To enter the passcode press **MENU**, then **BURNER SETTING**, then the **COM** button. This will prompt the keypad pane to appear, allowing the relevant passcode to be entered using the soft keypad and confirmed by pressing the **OK** button.

NOTE: The Supplier's Passcode (LV3) is six digits. Enter ALL, including any zeros, followed by the **OK** button.

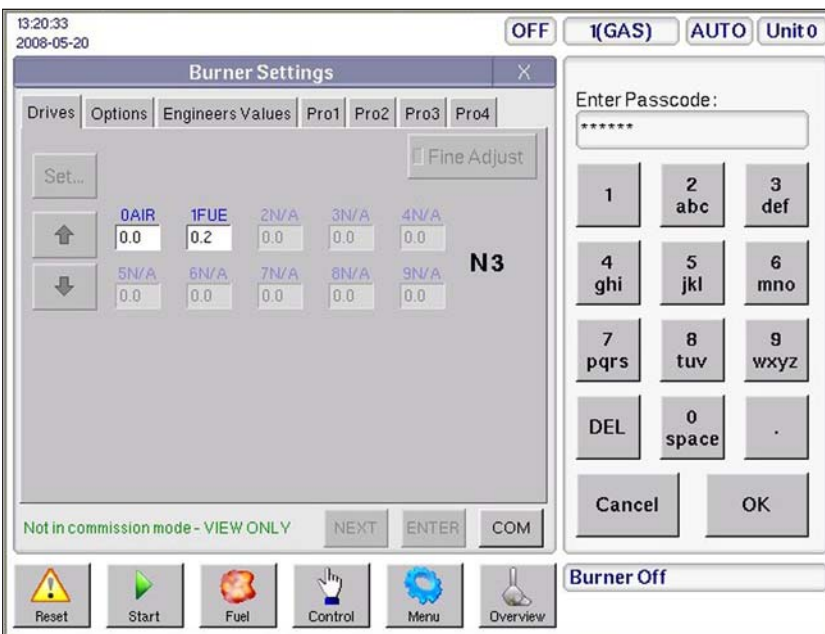



CAUTION

- Use extreme care while commissioning the system. While operating in commissioning mode the safety of the system is the sole responsibility of the commissioning engineer.
- Ensure a pre-purge position is entered for the relevant drives.
- Incorrect positioning of either fuel or air could cause a hazardous situation to occur.
- If the servo-motor positions have been up-loaded it is essential that the combustion is verified at each firing position to ensure a hazardous condition cannot occur, and for the data to be stored in the control.
- It is recommended that the close position for each servo motor is re-entered as part of the burner service regime, to compensate for wear in the servo-motor micro-switch during operation.
- Once all profile positions have been adjusted/entered it is essential that all profile points are checked to verify that the fuel air ration is acceptable for the appliance being controlled.

Once the correct passcode is entered the unit will enter commissioning mode and allow the option parameters and profile points to be adjusted, the text on the **COM** button will change to **RUN**. To warn the 'user' that the unit is in commissioning mode the overall display background changes to red and COM is displayed top-center on the screen

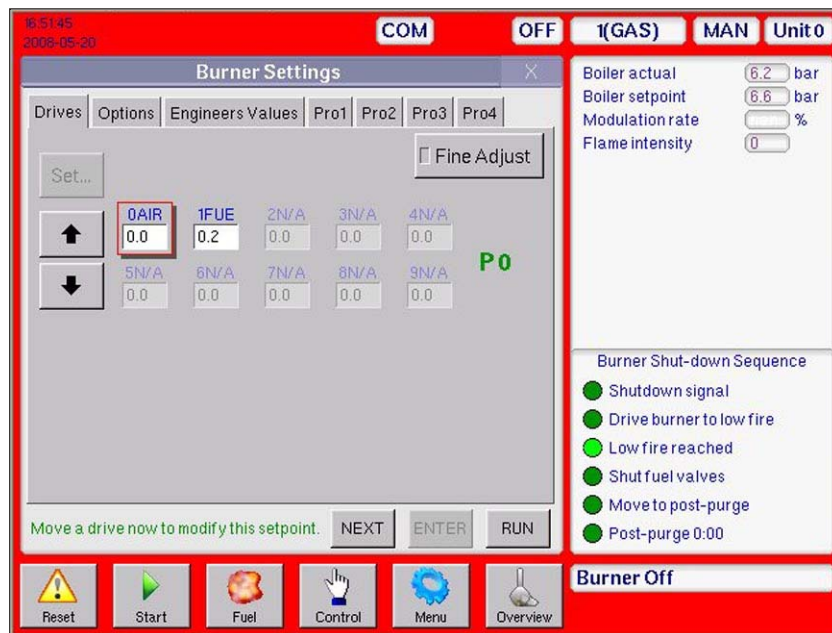

To enter or adjust Drive positions it is necessary to select the relevant Drive to be set, and then use the up/down arrows to move the drive to the required position. Set all the drive positions for each profile point before using the **ENTER** button to store the values and move to the next profile point (if already entered) then repeat the procedure for this point and any others required up to high fire.

NOTE: When adjusting servo motor positions, it may require the use of the “Fine Adjust” button to get the motor to the exact spot you desire.

Once the required values have been entered or changed the mode can be exited by pressing **RUN** followed by **ENTER**, the ‘X’ at the top right corner of the Burner Adjust window will be grayed out and inoperative.

5.5 Using option set mode

- Use the UP/DOWN keys to select the Option parameter to be adjusted.
- Use the Scroll (< >) keys to navigate between Option numbers and the Option values.
- Use the UP/DOWN keys to change the value of the option parameter. When the correct value is selected then press the ENTER key to store the new value.
- Set or adjust all of the parameters as required by moving between the parameters and adjusting as described above.

5.5.1 Option parameter list



CAUTION

- Use extreme care when entering option parameters. Incorrect data entry could cause a hazardous situation to occur.
- It is possible that additional parameters may be present in the unit depending on the application and/or supplier.

Note: Option parameters are marked with LV1, LV2, and LV3, which indicate what level passcode is required. If, when using the supplier passcode (LV3), it is not possible to adjust the value of an option parameter, then the burner must be turned off to make the adjustment.

Option 00.1 - Site passcode (0 - 999) DEFAULT VALUE is 154. LV3

This is a three-digit passcode that will allow the site engineer or end-user to enter option set mode and adjust a limited range of option parameters (those not marked with ‘LV2’ or ‘LV3’ in this section). This passcode can be zero, in which case the user only needs to press the COM / ENTER key twice to enter option set mode with limited access.

Option 00.2 - Serial communications control address (0 - 15) LV3

If the control is to be connected to other equipment via the serial communications interface, it must be given a unique address using this option parameter. Additionally if more than one control unit is connected on the CAN bus (for example to share a display), the units must all have unique addresses BEFORE THEY ARE CONNECTED TO THE SAME CANbus.



Option 00.3 - Reset hours run (0 - 1) LV3

This option parameter allows the HOURS RUN display for all fuels to be reset to zero. To perform a reset, set this option parameter to **1** and leave option set mode. When the burner begins to modulate, the HOURS RUN display will be reset and the option parameter automatically returns back to **0**.

Option 00.4 – User program select (0 / 1) LV1

This parameter may not be available. Where it is available, it allows the user to de-select the Fireeye’s standard modulation program, and select a user program. The user program may be modified using PC software to change the controls behavior for non-standard applications.

The programmable system only allows access to non-safety related functions such as modulation, enabling / disabling burner start-up and other similar functions. Only the user program can be modified, and Fireeye’s program can be re-selected at any time by changing this parameter back to zero.

Option 00.4 value	Meaning
0	Run standard manufacturer modulation program. Controls PID, control limits, and some Input / Output settings (see option parameters 20.0 to 29.9)
1	Run user program, if available.

Option 00.5 – Alternate Language select (0 / 1) LV1

DEFAULT: 0

This parameter may not be available. Where it is available, it allows the user to change the language used for the display. Depending on spare memory and customer requirements, this option may only change the text displayed to users in RUN mode, and not in COMMISSION mode – or all text can be changed to a second language.

Table below is for basic display. Language selection on the touchscreen is handled on the touchscreen directly.

Option 00.5 value	Meaning
0	Operate with standard language (usually ENGLISH).
1	Operate with alternate language, at least in RUN mode – but possibly in other modes depending on specification of the control.

Option 00.6 – Reserved

Option 00.7 – Modbus device address (1 – 99) LV3

Default value is 0= OFF

This option sets the Modbus device address for the controller and must be unique for each device on the bus.

NOTE: Only available with NXDBMB (Modbus) or NXDBVSD (variable speed drive) daughterboard installed.



Option 00.8 – Modbus communications speed (0 – 3) LV3

Default value 0

NOTE: Only available with NXDBMB (Modbus) or NXDBVSD (variable speed drive) daughterboard installed.

This option sets the Modbus communications speed in each controller as follows:

Option 00.8 value	Speed, bits/s
0	9600
1	4800
2	9600
3	19200

Option 01.0 – Power Up Option (0 - 30) LV3

DEFAULT 15 (after Sept 2011)

This option can be used to modify the behavior of the control at power-up.

Option 01.0 value	Meaning
0	Normal power-up. If no faults and fuel / burner selected, the burner will start.
1	Lockout. The burner will always lockout after a power-up. An F75 will be generated which will require manual intervention to clear.
2 – 30	The control will power-up as normal, but wait for 2 to 30 seconds before checking the digital inputs for fault conditions. This may be useful to prevent nuisance lockouts at power-up due to water levels and plant interlocks. The control will remain in safety shutdown (but not locked out) for this time.

Option 01.1 – Keyboard Auto/Manual enable (0 - 1) LV3 [Engineer's Key 33]

DEFAULT: 1

It is possible to enable/disable the auto/man facility from the keyboard. Selecting a 0 will disable the operation of the 'auto/man' function from the keyboard. Selecting a 1 will enable the operation of the 'auto/man' function from the keyboard.

Option 01.2 – Mute/Reset Input enable (0 - 2) LV3

The Mute/Reset function is available via Comfire 2, on the keyboard and can also be selected to be from a digital input. Selecting a non-zero value will enable the operation of the 'Mute/Reset' function from the corresponding digital input. It should be ensured that the digital input selected is not used for any other function (option parameters 1.x, 16.x and 18.x, 20.x). MUST be connected as shown in section 3.6.11.

Please note any key/button providing a fault mute function must be mounted local to the burner.

Number entered in parameter 01.2	Mute/Reset Function	Digital inputs used
0	Comview & Keyboard only	NONE
1	Input 1	Input 1, PA5 to PA11 Low Voltage
2	Input 2	Input 2, PA6 to PA11 Low Voltage
3	Input 3	Input 3, PA7 to PA11 Low Voltage
4	Input 4	Input 4, PA8 to PA11 Low Voltage

PPC → Option 02.x – Drive Name LV3



CAUTION

- The total electrical load for all connected servo motors **must not** exceed 40VA.

Each Drive connected to the system can be given a name which will then be shown on the text display, there are a maximum of 10 drives (0 – 9), which can be connected, the names are set by option parameter 02.0 to 02.9.

The drives are displayed with the drive number first, then a three character label, such as '1GAS', '2AIR', '3AIR' etc.

The permitted drive names are:

Number entered in parameter 02.X	Drive Name	Considered as:	Trim if selected:	Meaning
0	N/A	Not used	N/A	This drive will not be used.
1	FUE	Fuel drive	YES	Generic fuel drive
2	GAS	Fuel drive	YES	A gas drive
3	OIL	Fuel drive	YES	An oil drive
4	CUP	Fuel drive	YES	Cup speed for rotary cup burners
5	FGR	Fuel drive	NO	Flue Gas Recirculation damper
6	PUM	Fuel drive	YES	VSD controlled oil pump. Can be used for oil warming – see option parameter 9.8
7	WAS	Fuel drive	YES	Waste fuel (combined fuel firing)
8	PRI	Fuel drive	YES	Primary (flame shaping) air
9	FUE	Fuel drive	NO	Generic fuel, but not trimmed.
10	AIR	Air drive	YES	Main combustion air damper
11	FAN	Air drive	YES	Main combustion air fan
12	SEC	Air drive	YES	Secondary air (same as 10 apart from name)
13	AIR	Air drive	NO	Generic Air, but not trimmed.
14	SLE	Air drive	YES	Burner Sleeve

Two (or more) drives can be allocated the same name.

The number entered also tells the control information about the drive. If the number entered here is less than 10, the drive is considered a fuel. If the number is greater than or equal to 10, it is considered an air drive. This only makes a difference when oxygen trim is enabled for a particular drive, since it determines the trim direction. Selection of fuel trim or air trim is made with option parameters 31.1 to 31.4.

Primary air is considered a fuel drive since it is used for flame shaping and should normally track the fuel valve.

PPC → **Option 03.x – Drive Serial Number LV3**



CAUTION

- The total electrical load for all connected servo motors **must not** exceed 40VA.
- Due to the possibility of High Frequency electrical noise, **BOTH** ends of the shielded signal wire to the VSD **MUST** be grounded

Each Drive connected to the system has a unique serial number allocated to it during production testing. This number cannot be changed and is used to uniquely identify each drive.

When the system is in commissioning mode the serial number of all the connected drives is read by the PPC6000 and displayed as a 'list' to allow the selection of the relevant serial number unit for each drive (0 – 9) to be made.

Scrolling the list in an upward direction will scroll through all drive options available until '0, No Drive' is displayed. Enter this value to disconnect the specified drive from any hardware.

Scrolling the list in a downward direction will stop when the currently selected item is displayed, and the value will stop flashing.

The display will show type information for each drive present (such as the torque rating of a servo), but the commissioning engineer should be aware of which serial number servo is connected to which item on the burner.

If the optional VSD daughterboard is fitted, four additional options are present (reference section 2.6.18):

Displayed Option	Meaning
-a,VSD1:mA	VSD channel 1 is used with a 4-20mA feedback
-b,VSD1:Hz	VSD channel 1 is used with an encoder pulse (frequency) feedback
-c,VSD2:mA	VSD channel 2 is used with a 4-20mA feedback.
-d,VSD2:Hz.	VSD channel 2 is used with an encoder pulse (frequency) feedback.

If a drive serial number is changed, any profiles using that drive will require re-commissioning. A 'profile invalid' fault (see FAULT 64) will lock the burner out on an attempt to fire a profile which has had a previously commissioned drive removed. The profile can be re-commissioned by using the NEXT / ENTER keys in commission ratio mode to verify all points on the combustion curve.

PPC → **Option 04.x – Drive Usage Information LV3**

The system will allow a maximum of four fuel / air profiles to be entered. Each drive (servo or VSD) can be selected to operate for any, all or none of these profiles. For example: The system can be programmed to use the 'gas' servo on a gas profile – but not an oil profile.

When the control is firing a profile that doesn't use a specific drive that drive can be disconnected or faulty and the control will carry on working. For example, if the gas servo is broken, the burner can be run on oil.

The number to be entered is a binary code:

- +1 if the drive is used for profile 1,
- +2 if the drive is used for profile 2,
- +4 if the drive is used for profile 3,
- +8 if the drive is used for profile 4.

This means that the number entered is from 0 to 15: (see chart below):

Number entered in parameter 4.X	Drive X used for profile(s)
0	NONE
1	1
2	2
3	2+1
4	3
5	3+1
6	3+2
7	3+2+1
8	4
9	4+1
10	4+2
11	4+2+1
12	4+3
13	4+3+1
14	4+3+2
15	4+3+2+1 (ALL)

If these parameters are changed after the burner has been commissioned, any profiles affected will need to be re-commissioned. A 'profile invalid' fault (see FAULT 64) will lock the burner out on an attempt to fire a profile which has had a previously commissioned drive removed.

If a drive has been added / removed from a profile, it is recommended that the specified profile is erased (using option parameter 45.X) before an attempt is made to re-commission it.

Example of use:

- Option parameter 4.0 = 4 → drive 0 used for profile 3 only.
- Option parameter 4.2 = 1 → drive 2 used for profile 1 only.
- Option parameter 4.0 = 15 → drive 0 used for all profiles.
- Option parameter 4.4 = 5 → drive 4 used for profile 1 and profile 3 only.

Option 05.x – Drive Options LV3

This parameter is used to specify direction for each servo drive. This parameter has no effect for variable speed drives (VSD). If this parameter is changed, affected profiles must be re-commissioned by a qualified engineer. A 'profile invalid' fault (see FAULT 64) will lock the burner out until this is done.

Number entered in parameter 5.X	Drive Options
0	Drive moves anti-clockwise
1	Drive moves clockwise.

PPC → **Options 06.1-06.4 – Profile Naming LV3**

This selects the fuel associated with each profile (1 thru 4) to be displayed after the burner-on hours, e.g. 861 hours Profile 1 Gas, visible on the main display during operation.

Normally available options:

Number entered in parameter 6.X	Fuel solenoid valves opened
0	NONE
1	GAS1 + GAS2
2	OIL1
3*	GAS1 + GAS2 + OIL1

*selection 3 allows combined gas and oil firing. This selection may not be available on certain versions of this product.

In addition, for special applications further options may be allowed – again the availability depends of product version.

Options 07.x, 08.x– RESERVED

VSD → **Option 09.0 - Inverter control accuracy (0 / 1) LV3**

This parameter affects the inverter connected to the unit.

Option parameter 09.0 value	Meaning
0	Low accuracy (normal setting). Control will be performed to within approximately 9 display units, $\pm 0.54\text{Hz}$ for a 0-60Hz system.
1	High accuracy. Control will be performed to within approximately 3 display units, $\pm 0.18\text{Hz}$ for a 0-60Hz system.

Note: When using the high accuracy setting, the control may have difficulty with controlling the speed of the inverter. If this occurs, use the low accuracy setting for reliable operation.

VSD → **Option 09.1 - Inverter error tolerance (0 / 1) LV3**

This option parameter affects the inverter connected to the unit.

Option parameter 09.1 value	Meaning
0	Small tolerance (normal setting). The control will perform a non-volatile lockout if the inverter positioning error exceeds ± 30 for 15 seconds or ± 55 for 3 second (units conform to those seen on the display).
1	Large tolerance. The control will perform a non-volatile lockout if the inverter positioning error exceeds ± 55 for 3 seconds (units conform to those seen on the display).

Note: Only use the large tolerance setting if an inverter error of up to ± 55 will not cause an unsafe combustion condition to occur at any firing position.



Option 09.2 - Inverter closed loop gain (15 – 125%) LV3

DEFAULT: 100

This option parameter affects all inverters connected to the control.

For normal operation, use 100%. If the inverter control is unstable, reducing this value has the effect of damping the inverter's response as its speed approaches its setpoint.



Option 09.3 - Inverter stop time (0 – 100 seconds) LV3

Determines the minimum time between a burner shutdown and subsequent startup. Set this parameter to give the inverter sufficient time to stop before the burner restarts. This parameter will increase the time the burner is held in status 5.



Option 09.4 - Inverter acceleration time (0–100 seconds) (60 seconds max. recommended) LV3

DEFAULT 30

The value entered for this parameter should be the time in seconds for the inverter(s) to move from minimum to maximum speed.

The inverter(s) should also be able to move from maximum to minimum speed in the same time, if this is not the case adjust the time in the inverter(s) to ensure the time to accelerate and de-accelerate are the same.

If this option parameter does not match the true VSD acceleration / deceleration times, drive positioning will be compromised and position faults will be likely.

Note: This parameter can be set to values between 60 and 100, but this should only be used as a last resort if required, and is not recommended. If a very slow inverter is used, care must be taken during commissioning that UP / DOWN keys are not held for more than a few seconds. It is possible that the control could get out of step with the inverter and cause a position fault during the commission process. This control is not designed to work with inverters that take more than 60 seconds to drive from zero to maximum speed.



Option 09.5 – VSD1 Speed Encoder Scaler (255 - 999) LV3

When using encoder feedback for VSD1, this option should be programmed to ensure that the feedback signal gives between 950 and 995 when the motor is at maximum speed (drive signal at 20mA). The value for the parameter may be calculated using the following formula:

$$\frac{(\text{Motor Max RPM} \times \text{No of teeth on encoder})}{60} = \text{Scaler}$$

The value may need adjustment once the unit has been tested. Specifically, it must be ensured that the feedback received never exceeds this value. In practice this may mean adding 2% to 5% to this value. See section 9.2 for more details.

VSD → **Option 09.6 – VSD2 Speed Encoder Scaler (255 - 999) LV3**

When using encoder feedback for VSD2, this option should be programmed to ensure that the feedback signal gives between 950 and 995 when the motor is at maximum speed (drive signal at 20mA). The value for the parameter may be calculated using the following formula:

$$\frac{(\text{Motor Max RPM} \times \text{No of teeth on encoder})}{60} = \text{Scaler}$$

The value may need adjustment once the unit has been tested. Specifically, it must be ensured that the feedback received never exceeds this value. In practice this may mean adding 2% to 5% to this value. See section 9.2 for more details.

Option 09.7 – Reserved

Option 09.8 – Reserved

Option 14.0 – Primary Fault Relay (0 - 8) LV3
 DEFAULT: Relay 4 (PD5)

This option parameter assigns the primary faults to a specific relay. Relays 2 & 3 share a common connection on the NX610 display. NXTSD104 relays are independent.

Option parameter 14.0 value	Meaning	Connection Details NX610
0	Primary faults not assigned to any relay.	N/A
1	Primary faults assigned to relay 1	Display, PR3(COM), PR1(NC), PR2(NO). Low voltage or line voltage.
2	Primary faults assigned to relay 2	Display, PR7(COM), PR5(NC), PR6(NO). Low voltage or line voltage.
3	Primary faults assigned to relay 3	Display, PR7(COM), PR9(NC), PR8(NO). Low voltage or line voltage.
4	Primary faults assigned to relay 4	PPC6000, PE1(COM), PE4(NO). Low voltage or line voltage.
5	Reserved for future expansion	N/A
6	Reserved for future expansion	N/A
7	Primary faults assigned to relay 7	Daughterboard, PZ15 – PZ16. LOW VOLTAGE AND CURRENT ONLY.
8	Primary faults assigned to relay 8	Daughterboard, PZ17 – PZ18. LOW VOLTAGE AND CURRENT ONLY.

These relays MUST NOT be used to provide a safety function.

A relay can be used to indicate any combination of fault conditions from 14.0, 14.1 and 14.2 – this means that one relay could be used for all faults. When used for an alarm function, the relay will de-energize when in the fault condition, so an alarm bell would be wired in series with the normally closed contacts.



Option 14.1 – Limit Relay (0 - 8) LV3

DEFAULT: Relay 4 (PD5)

This option parameter assigns the limits to a specific relay. Relays 2 & 3 share a common connection on the NX610 display. NXTSD104 relays are independent.

Option parameter 14.1 value	Meaning	Connection Details NX610
0	Limits not assigned to any relay.	N/A
1	Limits assigned to relay 1	Display, PR3(COM), PR1(NC), PR2(NO). Low voltage or line voltage.
2	Limits assigned to relay 2	Display, PR7(COM), PR5(NC), PR6(NO). Low voltage or line voltage.
3	Limits assigned to relay 3	Display, PR7(COM), PR9(NC), PR8(NO). Low voltage or line voltage.
4	Limits assigned to relay 4	PPC6000, PE1(COM), PE4(NO). Low voltage or line voltage.
5	Reserved for future expansion	N/A
6	Reserved for future expansion	N/A
7	Limits assigned to relay 7	Daughterboard, PZ15 – PZ16. LOW VOLTAGE AND CURRENT ONLY.
8	Limits assigned to relay 8	Daughterboard, PZ17 – PZ18. LOW VOLTAGE AND CURRENT ONLY.

These relays MUST NOT be used to provide a safety function.

A relay can be used to indicate any combination of fault conditions from 14.0, 14.1 and 14.2 – this means that one relay could be used for all faults. When used for an alarm function, the relay will de-energize when in the fault condition, so an alarm bell would be wired in series with the normally closed contacts.

Option 14.2 – Oxygen and Flue Temperature Limit Relay (0 - 8) LV3

DEFAULT: Relay 4 (PD5)

This option parameter assigns the limits to a specific relay. Relays 2 & 3 share a common connection on the NX610 display. NXTSD104 relays are independent.

Option parameter 14.2 value	Meaning	Connection Details NX610
0	Flue Limits not assigned to any relay.	N/A
1	Flue Limits assigned to relay 1	Display, PR3(COM), PR1(NC), PR2(NO). Low voltage or line voltage.
2	Flue Limits assigned to relay 2	Display, PR7(COM), PR5(NC), PR6(NO). Low voltage or line voltage.
3	Flue Limits assigned to relay 3	Display, PR7(COM), PR9(NC), PR8(NO). Low voltage or line voltage.
4	Flue Limits assigned to relay 4	PPC6000, PE1(COM), PE4(NO). Low voltage or line voltage.
5	Reserved for future expansion	N/A
6	Reserved for future expansion	N/A.
7	Flue Limits assigned to relay 7	Daughterboard, PZ15 – PZ16. LOW VOLTAGE AND CURRENT ONLY.
8	Flue Limits assigned to relay 8	Daughterboard, PZ17 – PZ18. LOW VOLTAGE AND CURRENT ONLY.

A relay can be used to indicate any combination of fault conditions from 14.0, 14.1 and 14.2 – this means that one relay could be used for all faults. When used for an alarm function, the relay will de-energize when in the fault condition, so an alarm bell would be wired in series with the normally closed contacts.

PPC → **Option 15.0 - Modulation sensor input type (0 - 3) LV3**

The modulation sensor input caters for connection to a standard 0-5V, 4-20mA signal or a Fireeye fail-safe pressure/temperature sensor. When using a Fireeye fail safe sensor, the control may be used to monitor the boiler high safety limit and perform a non-volatile lockout if it is exceeded. Ensure that the links on the circuit board are set to correspond with the requirements of the sensor/signal being used. If a 4.20mA sensor (Fireeye PXMSxxx) is used it is still possible to set a safety limit, but an external limit device **must** be fitted to protect the boiler.

Option parameter 15.0 value	Meaning
0	0 - 5V operation. Set the JP1 link to 'OUT'. Set the JP3 link as required. This option is used to provide a 0 to 5 volt tracking input only. The burner modulation will track the voltage applied, going to high fire for 5 volts. There is no 'measured value', just a tracking setpoint. Option parameters 15.0 to 15.5 are unavailable.
1	4 - 20mA operation. Set the JP1 link to 'IN'. Set the JP3 link to '30V'. This option allows for connection to a 4 to 20mA pressure or temperature sensor. The burner modulation will track the current applied, going to high fire for 20mA and low fire for 4mA. If the current goes outside the range, the burner will go to low fire. There is no 'measured value', just a tracking setpoint. Option parameters 15.1 to 15.5 are unavailable.
2	4 - 20mA operation. Set the JP1 link to 'IN'. Set the JP3 link to '30V'. This option allows for connection to a 4-20mA measured value input device such as a pressure or temperature sensor. The internal PID will be used, if selected.

Option 15.1 – Modulation input decimal places (0 to 2)

This parameter specified the number of decimal places to which the measured value and setpoint are displayed. It also affects the scaling of the zero, span and safety limit – **it is vital that this parameter is set before parameters 15.2, 15.3 and 15.5**

Option parameter 15.1 value	Meaning
0	Measure value and setpoint displayed with no decimal places. Range of values is from 000 to 999.
1	Measure value and setpoint displayed with one decimal place. Range of values is from 00.0 to 99.9.
2	Measure value and setpoint displayed with two decimal places. Range of values is from 0.00 to 9.99.

 **Option 15.2 – Modulation input zero value (-999 to +999 / -99.9 to +99.9 / -9.99 to +9.99) LV3**

This value will normally be left at zero. It is the measured value to be displayed when the sensor connected is at its minimum value.

If a 4-20mA sensor is used, this parameter should be set to the 4mA value (usually zero).

NOTE: This option has been modified to allow for vacuum systems (available after June 2011).

 **Option 15.3 – Modulation input span value (-999 to +999 / -99.9 to +99.9 / -9.99 to +9.99) LV3**

This value is the measured value to be displayed when the sensor connected is at its maximum value.

If a 4-20mA sensor is used, this parameter should be set to the 20mA value.

NOTE: This option has been modified to allow for vacuum systems (available after June 2011).

 **Option 15.4 – Setpoint display units (0 – 3) LV3**

This option selects the displayed units for setpoint and measured value.

Option parameter 15.4 value	Meaning
0	Show measured value as 'PSI'.
1	Show measured value as 'bar'.
2	Show measured value as '°F'
3	Show measured value as '°C'
4	Show measured value as '%'
5	Show measured value as 'no units'

 **Option 15.5 - Boiler high safety limit (0 - 999 / 0.0 - 99.9 / 0.00 – 9.99) LV3**

If a 4-20mA sensor is used, and this parameter is set to a value other than zero, PPC6000 will *lockout* when the value is *exceeded*. **Note: When a 4-20mA sensor is used, external limits must be in place to protect the boiler in case of sensor failure. Zero disables this parameter.**

Option 15.6 – Modulation Time (0 – 120 seconds) LV3

This option parameter sets the minimum time the burner will take to modulate from low to high fire or vice versa. Note - only the modulation speed in AUTO mode is affected. The burner may modulate slower than this setting if the drive speeds dictate this at any point in the range.



Option 15.7 – Bumpless Transfer (0 or 1) LV3

This parameter affects the burner operation while in MANUAL mode only.

Option parameter 15.7 value	Meaning
0	When the burner comes back on after going off, it will remain at low fire.
1	When the burner comes back on after going off, it will go to the last modulation rate that it was set to in manual mode and stay there.

Option 15.8 – Low before Off (0 or 1) LV3

When set to 1, this parameter will change the way a normal controlled shutdown works.

Option parameter 15.8 value	Meaning
0	The burner will turn off immediately when it is expected / required to.
1	The burner will modulate down for up to 30 seconds (or until low fire is reached) and then turn off.

Note: This function works for shutdowns caused by control limits for the currently selected setpoint and for shutdowns caused by option parameter 20.1 (aux shutdown) only. Lockouts / shutdowns caused by the alarm inputs in parameters 18.X will always work immediately.

Option 15.9 - reserved

Option 16.1 – Go back to pilot (0 to 15) LV3

This option allows a digital input to be configured to force the control to modulate down to low fire (if not already there) and then move to the ignition position (P2) and close the main fuel valves. When at P2 the ignition-prove output (LFS) comes on. The burner will continue to run with only the pilot on (in status 12) until the digital input is removed. The ignition transformer will not come on during the time that the 'go back to pilot' input is on, however it may come on briefly when the input is removed as part of the normal start-up procedure, as determined by option parameter 14.6.

This function can be used to prevent the burner from having to go off when the demand is low, meaning that it is ready to immediately respond to a sudden increase in demand (no pre-purge required).

The digital input number to use for this function is entered as the option parameter value.

NOTE: This option should only be used if the pilot is designed for continuous operation. Consult the burner manufacturer, national, state and local codes.



Number entered in parameter 16.1	Digital input used:
0	None.
1	Input 1, PA5 to PA11 Low Voltage supplied from PA11 ONLY
2	Input 2, PA6 to PA11 Low Voltage supplied from PA11 ONLY
3	Input 3, PA7 to PA11 Low Voltage supplied from PA11 ONLY
4	Input 4, PA8 to PA11 Low Voltage supplied from PA11 ONLY
5	Do not use.
6	Do not use.
7	Not a real input. Used for custom applications.
8	Not a real input. Used for custom applications
9	Not a real input. Used for custom applications
10	Not a real input. Used for custom applications
11	Not a real input. Used for custom applications
12	Not a real input. Used for custom applications
13	Not a real input. Used for custom applications
14	Not a real input. Used for custom applications
15	Not a real input. Used for custom applications

Option 16.2 – Allow profile swap (0 to 16) LV3

This option allows a digital input to be configured to allow a profile swap without turning the burner off. If this input is ON and a fuel profile selection change is made, the control will go to low fire then back to pilot ignition (P2) on the original profile. It will then close the main fuel valves and run with just the pilot on (and the ignition transformer if option parameter 14.6 is not set to 1). It will then move all drives to the P2 position of the new profile and open the appropriate main fuel valves.

The digital input number to use for this function is entered as the option parameter value.

Number entered in parameter 16.1	Digital input used:
0	None.
1	Input 1, PA5 to PA11 Low Voltage supplied from PA11 ONLY
2	Input 2, PA6 to PA11 Low Voltage supplied from PA11 ONLY
3	Input 3, PA7 to PA11 Low Voltage supplied from PA11 ONLY
4	Input 4, PA8 to PA11 Low Voltage supplied from PA11 ONLY
5	Do not use.
6	Do not use.
7	Not a real input. Used for custom applications.
8	Not a real input. Used for custom applications
9	Not a real input. Used for custom applications
10	Not a real input. Used for custom applications
11	Not a real input. Used for custom applications
12	Not a real input. Used for custom applications
13	Not a real input. Used for custom applications
14	Not a real input. Used for custom applications
15	Not a real input. Used for custom applications



Option 17.0 – Relay output function LV3

This option parameter assigns 'events' to the relay outputs. Set option parameter 17.1 to select the function for relay output 1, option 17.2 to select the function for relay 2 etc.

Option parameter 17.x value	Meaning
0	No function set from this option parameter
1	Digital Input 1 (PB9 to PB10 Low Voltage)
2	Digital Input 2 (PB9 to PB11 Low Voltage)
3	Digital Input 3 (PB9 to PB12 Low Voltage)
4	Digital Input 4 (PB9 to PB13 Low Voltage)
5	Digital Input 5 (PB14 to PB15 Low Voltage)
6	Digital Input 6 (PB14 to PB16 Low Voltage)
7	Digital Input 7, (PB14 to PB17 Low Voltage)
8	Digital Input 8, (PB5 to PB6 Low Voltage)
9	Digital Input 9, (PB5 to PB7 Low Voltage)
10	Profile 2 select (PB6 – PB8) ONLY
11	Profile 4 select (PB7 – PB8) ONLY
12	i/p 12, PE4 to live High Voltage
13	i/p 13, PE5 to live High Voltage
14	i/p Burner Select (PE6)
15	Air Flow On
16	Warming limit exceeded
17	Flame Detected
18	Boiler Below Control Limit
19	Gas Profile Selected (profile fires gas)
20	Oil Profile Selected (profile fires oil)
21	Controller in 'Lockout'
22	Burner is Shutdown from a Limit or Input event
23	Burner on/off from the keypad (only applicable to touchscreen with NX6100)
24	N/A
25	Burner modulating
26	VSD Run
27	Fan Run
28	Gas booster function (ON status 6 to 16 inclusive if profile selected fires gas)
29	Lockout or shutdown as selection 21 or 22.
30	Draft control relay (ON at status 15-18 inclusive)
31	Profile 1 selected – same as 8
32	Profile 3 selected – same as 9
33	Profile 2 selected – same as 10
34	Profile 4 selected – same as 11
35	Spare
36	Spare
37	Spare
38	Burner Available – ON unless locked out or held OFF by fault or burner select or keypad is off.
39	Purging – burner status = 8 (Firmware Version 1.204 and above)
40	Purge Complete – burner status = 9 (Firmware Version 1.204 and above)
41	Burner NOT turned off from keyboard / touchscreen.
42	Relay de-energized
43	Relay on if in normal mode (inverse of 23). Relay off if in local mode, or control powered off.
44	Relay on if control is powered up.



Option parameter 17.x value	Meaning
45	Relay ON status 2 onwards and during lockout post-purge (Fan on if burner on or waiting for burner select.)
46	Burner available. Relay on status 2 to 16 inclusive.
47	Low fire output.
48	High fire output.
49 – 100	+
101 – 199	Fault numbers 1 – 99 control the relay
200	Relay de-energized
201 - 250	EK101 – EK150 control the relay

Details of the relay connection details are shown below. Relays 2 & 3 on the display share a common connection and 4 & 5 on the PPC6000ler share a common connection. When used to indicate a fault or limit the N/O contacts will be closed when **NO** alarm is present, to ensure the alarm indication is fail-safe, therefore alarm devices should be wired to the normally closed contacts.

Abbreviations: Com.= Common, N.C. = normally closed, N.O. or N. Open = normally Open

A) For NX610 – 9-key keypad, if set as Alarm, no alarm present, at power up, relays change state as follows::

NOTE: No connection to terminal 4 on NX610 display

Option Parameter	Relay Output	ALARM Function Connection Detail for NX610 Only			
17.1	1	Display, Low or Line voltage	PR1	Normally Closed	
			PR2	Normally Open	
			PR3	Common	
17.2	2	Display, Low or Line voltage.	PR5	Normally Closed	
			PR6	Normally Open	
			PR7*	Common	
17.3	3	Display, Low or Line voltage	PR7*	Common	
			PR8	Normally Open	
			PR9	Normally Closed	
17.4	4	PPC6000, PE1 PE4 Line voltage output ONLY			
17.5	5	N/A			
17.6	6	N/A			
17.7	7	NXDBVSD, PZ15, PZ16, Low voltage <50V AC/DC, 200mA			
17.8	8	NXDBVSD, PZ17, PZ18, Low voltage <50V AC/DC, 200mA			
17.9	9	Available on NXTSD104 Touchscreen display ONLY			

* common to relays 2 and 3

B) For NX610, if set as General Purpose relay, connections are as follows::

NOTE: You MUST recycle power to reset relay function first

Option Parameter	Relay Output	GENERAL PURPOSE Connection Detail for NX610 Only		
17.1	1	Display, Low or Line voltage	PR1	Normally Open
			PR2	Normally Closed
			PR3	Common
17.2	2	Display, Low or Line voltage	PR5	Normally Open
			PR6	Normally Closed
			PR7*	Common
17.3	3	Display, Low or Line voltage.	PR7*	Common
			PR8	Normally Closed
			PR9	Normally Open
17.4	4	PPC6000, PE1 PE4 Line voltage output ONLY		
17.5	5	N/A		
17.6	6	N/A		
17.7	7	NXDBVSD, PZ15, PZ16, Low voltage <50V AC/DC, 200mA		
17.8	8	NXDBVSD, PZ17, PZ18, Low voltage <50V AC/DC, 200mA		
17.9	9	Available on NXTSD104 Touchscreen display ONLY		

* common to relays 2 and 3

For Example:

If you want an indicator light to illuminate when the warming limit is exceeded (released to modulate) -

1. Use one of the three display relays – for this example #1
2. Set 17.1 (for relay 1) to 16 (value for warming limit exceeded)
3. The contacts between PR3 and PR2 close when this is true.

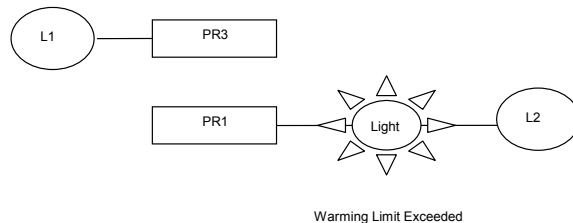

Abbreviations: Com.=

N.O. or N. Open = normally Open

Common, N.C. = normally closed,

C) For NXTSD104, if set as Alarm, no alarm present, at power up, relays change state as follows::



Option Parameter	Relay Output	ALARM Function Connection Detail for NXTSD104 Only			
17.1	1	Display, Low or Line voltage	PR1	Common	
			PR2	Normally Open	
			PR3	Normally Closed	
17.2	2	Display, Low or Line voltage	PR4	Common	
			PR5	Normally Open	
			PR6	Normally Closed	
17.3	3	Display, Low or Line voltage	PR7	Common	
			PR8	Normally Open	
			PR9	Normally Closed	
17.4	4	PPC6000, PE1 PE4 Line voltage output ONLY			
17.5	5	N/A			
17.6	6	N/A			
17.7	7	NXDBVSD, PZ15, PZ16, Low voltage <50V AC/DC, 200mA			
17.8	8	NXDBVSD, PZ17, PZ18, Low voltage <50V AC/DC, 200mA			
17.9	9	Available on NXTSD104 display ONLY	PR10	Common	
			PR11	Normally Open	
			PR12	Normally Closed	

D) For NXTSD104, if set as General Purpose relay, connections are as follows:

NOTE: If any relay has been previously selected for alarm purpose, power MUST be recycled to reset the relay AFTER changing that relay to general purpose.

Option Parameter	Relay Output	GENERAL PURPOSE Connection Detail for NXTSD104 Only			
17.1	1	Display, Low or Line voltage	PR1	Common	
			PR2	Normally Closed	
			PR3	Normally Open	
17.2	2	Display, Low or Line voltage	PR4	Common	
			PR5	Normally Closed	
			PR6	Normally Open	
17.3	3	Display, Low or Line voltage	PR7	Common	
			PR8	Normally Closed	
			PR9	Normally Open	
17.4	4	PPC6000, PE1 PE4 Line voltage output ONLY			
17.5	5	N/A			
17.6	6	N/A			
17.7	7	NXDBVSD, PZ15, PZ16, Low voltage <50V AC/DC, 200mA			
17.8	8	NXDBVSD, PZ17, PZ18, Low voltage <50V AC/DC, 200mA			
17.9	9	Available on NXTSD104 display ONLY	PR10	Common	
			PR11	Normally Closed	
			PR12	Normally Open	

Option 18.1 to 18.4 – Low Voltage Fail-safe Alarm / Lockout Inputs (0 – 460) LV3

These functions are all fail-safe and may be used to lockout or shutdown the burner. The fault number generated always relates directly to the input that caused the fault (by going open circuit). Thus F1 references input 1, F4 references input 4.

The lockout functions themselves are activated by putting a number into option parameters 18.1 to 18.4 for inputs 1 to 4. The number is a one, two or three digit number defined as follows (zero gives no function).



NOTE: In order to enable any Digital Input, a value greater than 0 **MUST** be entered in one of the three columns.

HUNDREDS (fault type)	TENS (fuel type)	UNITS (burner status type)
0 – This alarm will lockout the burner and shows on the display as ‘FXX’. Manual intervention (fault mute) is required to restart the burner once the fault condition has cleared. The burner will lockout within one second.	0 or 1 – Fault will be active for any fuel selection (including no fuel selected at all).	0 or 1 – Fault will be active regardless of the current burner status (i.e. all the time).
1 – This alarm will shutdown the burner and show on the display as ‘FXX’. When the fault condition clears, this fault will change to ‘CXX’ and the burner will restart without manual intervention. The burner will shutdown within one second.	2 – Fault will be active only when the currently selected profile fires GAS.	2 – Fault will be active after the fan has started, the air pressure switch has made and the drives have made their purge positions (i.e. once pre-purge starts). Not active during post purge.
2 – This alarm is for indication only. It will appear on the display as ‘LXX’ but will not stop the burner operating. The limit will operate within three seconds.	3 – Fault will be active only when the currently selected profile fires OIL.	3 – Fault will be active after pre-purge has finished (i.e. drives moving to the ignition position). Not active during post purge.
3 – This operates the same as selection 1 in this column, but the fault will be generated when the input closes. This should not be used for any safety function because if the wire breaks, it cannot be detected.	4 – Fault will be active only when there is a fuel profile currently selected (either firing GAS or OIL).	4 – Fault will be active after pilot ignition has started (status 11 onwards). Not active during post purge.
4 – This alarm will shutdown the burner and show on the display as ‘FXX’. When the fault condition clears, this fault will change to ‘CXX’ and the burner will restart without manual intervention. The burner will shutdown within three seconds.	All other values will work like selection 1 (including zero). 5 to 9 are spare so new functions can be added later.	5 – Fault will be active after main ignition has started (status 13 onwards). Not active during post purge.
5 to 9 are spare and can’t be selected.		6 – Fault will be active after the drives have reached their low fire positions and the burner is ready to modulate (status 16). Not active during post purge. 7 -- fault activates at ignition only (status 10 to 14 inclusive)

continued on next page



HUNDREDS (fault type)	TENS (fuel type)	UNITS (burner status type)
		8 - fault activates at pre-purge only (status 8)
		All other values will work like selection 1 (including zero). 7 to 9 are spare so new functions can be added later.

NOTE: In order to enable any Digital Input, a value greater than 0 **MUST** be entered in one of the three columns.

Option parameter number	Digital Input Number / Terminals	Fault number
18.1	Input 1 – PA5 to PA11 LOW VOLTAGE supplied from PA11 ONLY	F1 or L1
18.2	Input 2 – PA6 to PA11 LOW VOLTAGE supplied from PA11 ONLY	F2 or L2
18.3	Input 3 – PA7 to PA11 LOW VOLTAGE supplied from PA11 ONLY	F3 or L3
18.4	Input 4 – PA8 to PA11 LOW VOLTAGE supplied from PA11 ONLY	F4 or L4

Option 19.1 to 19.4 – Fail-safe Alarm / Lockout Display Messages LV3

The lockout functions are completely separate from the lockout messages. The messages are chosen from a list of 32 possible items using option parameters 19.1 to 19.4 (for inputs 1 to 4) and option parameters 16.5 & 16.6 for the high voltage inputs (12 & 13). These are the default messages, but at least some of them can be modified using serial communications and a PC.

Option parameter 19.X (or 16.5 / 16.6) value	Meaning
0	Alarm Input Open
1	Low Water
2	Extra Low Water
3	High Water
4	High Gas Pressure
5	Low Gas Pressure
6	High Oil Pressure
7	Low Oil Pressure
8	High Oil Temp.
9	Low Oil Temp.
10	Low Atom. Media
11	High Temperature
12	Low Temperature
13	High Pressure
14	Low Pressure
15	Panel Switch Open
16	High Stack Temp.
17	Fan Interlock
18	End Switch Open
19	Oil Interlock
20	Gas Interlock
21	Forced Lockout
22	High High Water
23	OilGun Interlock

Option parameter 19.X (or 16.5 / 16.6) value	Meaning
24	Low Draft
25	BurnerDoorSwitch
26	Emergency Stop
27	ExitDamperClosed
28 to 31	(spare)



CAUTION

- The product allows for customization of various non-safety critical functions including the modulation control. The option parameters shown below relate to the default modulation control function programmed in the control at the factory. To verify this has not been replaced by an application specific function check with the equipment supplier and / or check option parameter 00.4, if available.

Option 20.0 – Set-point Select input (0 - 35) LV3

This option parameter allows for a digital input to be used to select between modulation setpoint sets 1 and 2 (see option parameters 21.0 and 22.0).

- (1 – 4) Open = Setpoint 1, Closed = Setpoint 2
- (16 or 20) Permanently Closed = Setpoint 2
- (21 – 24) Closed = Setpoint 1, Open = Setpoint 2

NOTE: Options 20.0 to 20.6 and 20.8 have two operational modes. In one case a “high,” level or voltage present, as would be the case of a closed switch, will result in the action specified. In the other case, a “low” level or open switch would cause the action specified.

For example:

- If option 20.1 [boiler shut down] is wired to input 2 (low voltage PA6-PA11) and programmed as 20.1 = 2, the boiler would stay off as long as the switch is closed. In this case if the wire fell off, the boiler would START.
- To reverse this function, option 20.1 would be set as 20.1 = 22. This would require the switch be closed to start the boiler. In this case, if the wire fell off, the boiler would SHUT DOWN.

The table below indicates the value for each of these inputs to affect the desired condition.

Please consider the “broken wire” condition when programming these options.



Option Table 20.0 A

Digital Input Numbers Input CLOSED Powered ON	Digital input used:	Digital Input Numbers Input OPEN Powered OFF
0	None. Input disabled.	20
1	Input 1, PA5 to PA11 LOW VOLTAGE supplied from PA11 ONLY	21
2	Input 2, PA6 to PA11 LOW VOLTAGE supplied from PA11 ONLY	22
3	Input 3, PA7 to PA11 LOW VOLTAGE supplied from PA11 ONLY	23
4	Input 4, PA8 to PA11 LOW VOLTAGE supplied from PA11 ONLY	24

Option 20.1 – Boiler Shutdown input (0 - 35). LV3

- (1 – 4) A high level on the input specified here will cause the boiler to go off and stay off until it is removed. No fault / alarm is generated.
- (16 or 20) **Will cause the burner to SHUT OFF permanently. Should NOT be used.**
- (21 – 24) A low level on the input specified here will cause the boiler to go off and stay off until it is switched high (ON). No fault / alarm is generated.

The input numbers are as specified in Option Table 20.0 A above. This is useful when integration to a building management system is required.

Option 20.2 – Low Fire Hold input (0 - 35). LV3

- (1 – 4) A high level on the input specified here will cause the boiler to go to low fire and stay there until it is removed.
- (16 or 20) **Should NOT be used.**
- (21 – 24) A low level on the input specified here will cause the boiler to go to low fire and stay there until it is switched high (ON).

The input numbers are as specified in Option Table 20.0 A above.

Option 20.3 – Oxygen Trim Disable input (0 - 35). LV3

- (1 – 4) A high level on the input specified here will cause the oxygen trim function to switch off (if it is selected) until it is removed.
- (16 or 20) **Should NOT be used.**
- (21 – 24) A low level on the input specified here will cause the oxygen trim function to switch off (if it is selected) until it is switched high (ON).

The input numbers are as specified in Option Table 20.0 A above. See option parameter 30.5.



Option 20.4 – Ignition Wait input (0 - 35). LV3

- (1 – 4) A high level on the input specified here will prevent the burner from igniting. The drives stay at their ignition positions, but the light up sequence will not start until this input is removed.
- (16 or 20) **Should NOT be used.**
- (21 – 24) A low level on the input specified here will prevent the burner from igniting. The drives stay at their ignition positions, but the light up sequence will not start until this input is switched high (ON).

The input numbers are as specified in Option Table 20.0 A above.

Option 20.5 – Purge Hold input (0 - 35). LV3

- (1 – 4) A high level on the input specified here will prevent the burner moving on past pre-purge. The drives stay at their purge positions, until this input is removed.
- (16 or 20) **Should NOT be used.**
- (21 – 24) A low level on the input specified here will prevent the burner moving on past pre-purge. The drives stay at their purge positions, until this input is switched high (ON).

The input numbers are as specified in Option Table 20.0 A above.

Option 20.6 – Purge Time Start input (0 - 35). LV3

- (1 – 4) A high level on the input specified here will prevent the pre-purge time from starting. The drives stay at their purge positions, until this input is removed and the specified pre-purge time has elapsed.
- (16 or 20) **Should NOT be used.**
- (21 – 24) A low level on the input specified here will prevent the pre-purge time from starting. The drives stay at their purge positions, until this input is switched high (ON) and the specified pre-purge time has elapsed.

The input numbers are as specified in Option Table 20.0 A above.

Option 20.7 – Analog Input 5 function (0 - 2). LV3

This parameter allows analog input 5 (the second modulation input PA12 and PA13 to perform specific functions.

Option parameter 20.7 Value	Digital input used:
0	This input does nothing.
1	Remote tracking input. If the control is in AUTO modulation mode accepting remote inputs, and a valid 4-20mA signal is applied, the control will modulate so as to track this input. 4mA = Low fire, 20mA = High fire. If the signal goes below 3.5mA or above 21mA, this mode will be cancelled and normal PID modulation will resume.
2	Remote Setpoint 1 Input. If the control is in AUTO modulation mode accepting remote inputs, the value of setpoint 1 can be overridden when a valid 4-20mA signal is applied to this input. The zero and span are set in option parameters 21.8 and 21.9. If deviation limits are set (see option parameter 21.5), then the high and low control limits will also move with the setpoint. If the signal goes below 3.5mA or above 21mA, this mode will be cancelled and normal setpoint 1 value will be applied.

Option 20.8 – Digital Input - Lead Boiler Select (0 – 35) LV3

- (1 – 4) A high level on the input specified here will select the lead boiler when closed.
(16 or 20) **Should NOT be used.**
(21– 24) A low level on the input specified here will select the lead boiler when open.

The input numbers are as specified in Option Table 20.0 A above.

**NOTE: For the following Options 21.x and 22.x,
see Section 9.7.10 for PID Tutorial.**

Option 21.0 – Set-point 1 enable (0 - 1) LV1

This option parameter is used to select setpoint 1.

Option 21.1 – Set-point 1 control value (0 - 999 / 00.0 - 99.9 / 0.00 - 9.99) LV1

This is the desired pressure or temperature control value used in the PID control loop for setpoint 1. When the control is in auto mode, the PID control loop will modulate the boiler to maintain the measured value at the same level as set by this parameter.

Option 21.2 – Set-point 1 proportional band (0 - 999 / 00.0 - 99.9 / 0.00 - 9.99) LV1

This is the width of the proportional (modulation) band that is used by the PID control loop for setpoint 1. For example, if the setpoint was 100 psi, and this term was set to 10 psi, then the proportional band would be from 90 psi to 100 psi. A measured value of 90 psi would give high fire, and 100 psi would give low fire, assuming no integral or derivative terms were entered.

A value of 0 means no proportional band – the burner would stay at low fire until the high limit (Cut Out) is reached, then turn off. Proportional control is therefore needed to allow the burner to modulate.

Option 21.3 – Set-point 1 integral time (0 – 999 seconds) LV1

This is the integral time used in the PID control loop for setpoint 1. It may be set to any value from 0 to 999, seconds. If a value of 0 is entered the integral function is disabled, otherwise the time entered is the number of seconds the control will take to give an additional modulation change equal to that currently given by the proportional term. The lower the number (apart from zero), the more affect the integral function has. A large number will cause the integral term to act very slowly.

Integral control is required for the burner to accurately reach its setpoint.

Option 21.4 – Set-point 1 derivative time (0 – 999 seconds) LV1

This is the derivative time used in the PID control loop for setpoint 1. It may be set to any value from 0 to 999. A value of zero will disable the derivative function. A non-zero value will have the effect of ‘advancing’ the modulation rate change caused by a constantly changing measured value by the number of seconds given. A low value will have little effect; a large value will cause a large effect.

Derivative control is seldom needed for boilers, but can improve the response of the modulation system to sudden load changes. Too much can cause control instability.

Option 21.5 - Setpoint 1 control limit type (0 - 2) LV3

This option parameter defines the control limit type for setpoint 1. The control limits are used to automatically turn the burner off when it is not needed, and bring it back on when it is needed.

Option parameter 21.5 value	Meaning
0	No limits. The burner will run until another method is used to switch it off.
1	Absolute limit. The values entered in option parameters 21.6 and 21.7 are the actual limit values.
2	Deviation limit. The values entered in option parameters 21.6 and 21.7 represent a deviation (i.e. offset) from the setpoint 1 control value. This means that if the setpoint control value is changed, the limits are automatically changed correspondingly.

Option 21.6 - Setpoint 1 low limit control value (Cut In) (0 - 999 / 00.0 - 99.9 / 0.00 - 9.99) LV1

If the boiler is off due to a controlled shutdown, this parameter defines the measured value at which the boiler will be turned on again.

Option 21.7 - Setpoint 1 high limit control value (Cut Out) (0 - 999 / 00.0 - 99.9 / 0.00 - 9.99) LV1

If the boiler is on and firing, this parameter defines the measured value at which the boiler will be turned off via a controlled shutdown.

Option 21.8 – Remote Setpoint 1 zero (4ma) value (0 - 999 / 00.0 - 99.9 / 0.00 - 9.99) LV1

This is the zero value for the remote setpoint function specified by option parameter 20.7.

Option 21.9 – Remote Setpoint 1 span (20mA) value (0 - 999 / 00.0 - 99.9 / 0.00 - 9.99) LV1

This is the span value for the remote setpoint function specified by option parameter 20.7.

Option 22.0 – PID (set-point) 2 enable (0 - 1) LV1

This option parameter is used to select setpoint 2.



Option 22.1 – Set-point 2 control value (0 - 999 / 00.0 - 99.9 / 0.00 - 9.99) LV1

This is the control value used in the PID control loop for setpoint 2. When the control is in auto mode, the PID control loop will modulate the boiler to maintain the measured value at the same level as set by this parameter.

Option 22.2 – Set-point 2 proportional band (0 - 999 / 00.0 - 99.9 / 0.00 - 9.99) LV1

This is the width of the proportional (modulation) band that is used by the PID control loop for setpoint 2. For example, if the setpoint was 100 psi, and this term was set to 10 psi, then the proportional band would be from 90 to 100 psi. A measured value of 90 psi would give high fire, and 100 psi would give low fire, assuming no integral or derivative terms were entered.

A value of 0 means no proportional band – the burner would stay at low fire until the high limit (Cut Out) is reached, then turn off. Proportional control is therefore needed to allow the burner to modulate.

Option 22.3 – Set-point 2 integral term (0 – 999 seconds) LV1

This is the integral time used in the PID control loop for setpoint 2. It may be set to any value from 0 to 999, seconds. If a value of 0 is entered the integral function is disabled, otherwise the time entered is the number of seconds the control will take to give an additional modulation change equal to that currently given by the proportional term. The lower the number (apart from zero), the more affect the integral function has. A large number will cause the integral term to act very slowly.

Integral control is required for the burner to accurately reach its setpoint.

Option 22.4 – Set-point 2 derivative term (0 - 100) LV1

This is the derivative time used in the PID control loop for setpoint 2. It may be set to any value from 0 to 999. A value of zero will disable the derivative function. A non-zero value will have the effect of ‘advancing’ the modulation rate change caused by a constantly changing measured value by the number of seconds given. A low value will have little effect; a large value will cause a large effect.

Derivative control is seldom needed for boilers, but can improve the response of the modulation system to sudden load changes. Too much can cause control instability.

Option 22.5 - Setpoint 2 control limit type (0 - 2) LV3

This option parameter defines the control limit type for setpoint 2. The control limits are used to automatically turn the burner off when it is not needed, and bring it back on when it is needed.

Option parameter 22.5 value	Meaning
0	No limits. The burner will run until another method is used to switch it off.
1	Absolute limit. The values entered in option parameters 22.6 and 22.7 are the actual limit values.
2	Deviation limit. The values entered in option parameters 22.6 and 22.7 represent a deviation (i.e. offset) from the setpoint 1 control value. This means that if the setpoint control value is changed, the limits are automatically changed correspondingly.



Option 22.6 - Setpoint 2 low limit control value (0 - 999 / 00.0 - 99.9 / 0.00 - 9.99) LV1

If the boiler is off due to a controlled shutdown, this parameter defines the measured value at which the boiler will be turned on again.

Option 22.7 - Setpoint 2 high limit control value (0 - 999 / 00.0 - 99.9 / 0.00 - 9.99) LV1

If the boiler is on and firing, this parameter defines the measured value at which the boiler will be turned off via a controlled shutdown.

Option 22.8 – Maximum modulation rate

DEFAULT 0 – unlimited / Range 1 – 100%

Values represent: 0 = unlimited
1 – 100 is maximum %

Option 22.9 – Reserved

Option 23.0 – Warming Enable (0 or 1) LV1

This parameter allows a warming function to be applied to the boiler, and makes option parameters 23.1 and 23.2 available. If zero is entered, no warming limit is applied.

Option 23.1 – Warming Limit (0 - 999 / 00.0 - 99.9 / 0.00 - 9.99) LV1

If, when the burner starts up and reaches modulation, the measured pressure / temperature value is lower than that specified here, the control will hold the boiler at low fire until the value specified is reached. The control will hold the boiler at low fire (in status 15) indefinitely unless a non-zero time has been entered in option parameter 23.2.

Note: If during normal modulation, the measured value falls below this limit having once been above it, the warming function will not be re-applied. The warming function is only applied on a burner start-up.

Option 23.2 – Warming Time (0 to 999 minutes) LV1

This parameter specifies a maximum time to hold the burner at low fire for, before ignoring the warming limit and allowing normal modulation.

Additionally, when the burner goes off (for any reason other than power interruption), and the measured value falls below the warming limit, the warming function will not be activated again until this time has passed.

NOTE: Further parameters (up to 29.9) may be available here if they are part of a users program or non-standard manufacturers program.



Options 24.x – Sequencing

Sequencing (lead/lag) is managed by using the “setpoint select” function internally to choose between Setpoint 1 and Setpoint 2 via the communications bus between PPC6000’s. The “lead” or “master” boiler controls the “lag” or “slave” boiler(s) by switching them from setpoint 2 (“lag stand by” or “banking”) to the setpoint 1 values, and turns on based on Option 24.6 (lag (slave) On Rate) value. The lead boiler will override the modulation rate of the last lag boiler to come on and cause it to modulate in unison with the lead (master) boiler. If both the lead (master) boiler and last lag (slave) boiler remain above the Option 24.6 value another lag (slave) boiler will be started after Option 24.7 (lag (slave) on delay) value has expired. Other lags (slaves) that are on will remain at high fire until the last lag is turned off. At this point, the next lag boiler will begin to modulate with the lead (master) and so on until the lead (master) is carrying the load. The sequence in which boilers are turned on is set in Option 24.1-24.3 via communications addresses of each PPC6000. When a lead (master) boiler is deselected as lead (master) and Option 24.0 has not been changed to 0, the boiler remains as lead (master) until a new lead (master) takes control. Once the new lead (master) takes control, the previous lead (master) may be turned off based on the demand and Option 24.1-24.3 settings.

If the lead (master) boiler is turned off, or fails to come on within three minutes, while operating as the lead, sequencing will be disabled and all lag (slave) boilers will revert to their own PID settings. Should a lag boiler fail to come on within three minutes, or the PPC6000 is faulted, sequencing will immediately call for the next lag in the priority list.

If the lead (master) boiler is switched to manual modulation it will remain as lead bringing on lag (slave) boilers as required. This will allow the operator to “base load” a lead boiler if required.

The PPC6000 can be the “master” (lead) boiler in a system that has PPC5000 or NX3100/4100 series as the communications message are the same. The PPC6000 cannot be controlled by the PPC5000 or NX3100/4100 series controls as a boiler.

Stand by or Banking values

The “lag stand by” or “banking” temperature or pressure is entered as PID 2 or Setpoint 2 values however, options 22.2, 22.3, 22.4 (the P, I and D) values are unnecessary as the burner will start and remain at low fire until the “lag stand by” or “banking” cut out is reached. These values will be entered by;

1. Setting option parameter 22.0 to 1 (Enable Setpoint 2)
2. Setting option parameter 22.1 to the desired setpoint value when in stand by.
3. Setting option parameter 22.5 to 1 (Absolute Value)
4. Setting option parameter 22.6 to the desired cut in value when in stand by.
5. Setting option parameter 22.7 to the desired cut out value when in stand by.

For example: If the normal operating setpoint is 100 PSI, and the desired stand by pressure is 75 PSI. The setup would be:

Option Parameter	Setting
22.0	1
22.1	75
22.5	1
22.6	75 (cut in or minimum pressure)
22.7	80 (cut out or maximum pressure)



STANDBY WATER TEMPERATURE FOR STEAM BOILER

If a steam boiler is being banked based on boiler temperature, a temperature sensor must be fitted into the boiler water jacket. The temperature sensor must be a 4-20mA device. If this device is to be loop-powered by the PPC6000, it should be connected to the 30V output, “sensor supply” on PA16. See option 25.0 – 25.5.

Example:

Fireye Temp. Sensor – TS350	PPC6000	
Sensor Terminal (1) 4-20mA	PPC6000 Terminal	PB8 or PA12
Sensor Terminal (2) Current	PPC6000 Terminal	PA5, PA6, PA7, PA8

The blocks program needs to be 15 or higher.
EK200 shows the current version

Option/Parameters

20.7 = 0 – If using AUX. input 5. Using inputs 1, 2, 3 will allow the boiler water temperature to be displayed on the TSD104. Input 4 will **NOT**.

25.0 = 1 - Analog input 1, (PA5 to PA12 or PB8. Input 2,3 & 4 will also be powered from PA12 or PB8.

25.1 = 32, Zero value of temp. sensor.

25.2 = 350, Span value of temp. sensor.

25.3 = Cut-in temp.

25.4 = Cut-out temp.

No PID involved, lag boiler will turn on and off on low fire.

Relevant Engineers Keys:

EK115, EK120 to EK139 and EK159

NOTE: When using sequencing, setpoint 2 is unavailable for use with any digital input unless the boiler is removed from sequencing completely.

Option 24.0 Sequence Slaves (number of boilers) (0-3) LV1

This option is set to 1, 2 or 3 in each PPC6000 to equal the number of lag “slave” boilers in the system. Once set, option parameters 24.1, 24.2, and 24.3 will become available. If the value is set to 0 the boiler will be taken out of sequencing and operate on its own PID.

NOTE: OPTION PARAMETER 00.6 MUST BE SET TO 0 FOR SEQUENCING TO OPERATE. ON NEWER PPC6000’s, Option 0.6 has been moved to the NX610 display. Press and hold the DATA key for 5 seconds. Position the cursor to NORM for sequencing. See Section 4.1 for details.

Option 24.1 -24.3 Priority Number(s) LV1

The order in which boilers sequence on is entered as the communication address(s) of the boilers in **Options 24.1, 24.2 and 24.3**. The first to be turned on will have a priority number one above that of the lead boiler.

For example: If the communications address of the four boilers were 1, 2, 3, and 4 (**set in Option 0.2**), boiler 1 master (lead), with the following entered in **Options 24.1-24.3**



Option parameter 24.x value	Comms. Address	Boiler
24.1	2	2
24.2	3	3
24.3	4	4

The sequencing order would be boiler 2, 3 and 4. If boiler 2 were set to lead via **Option 24.5**, the order would be boiler 3, 4 and 1. Setting boiler 3 to master (lead), the order would be boiler 4, 1 and 2. Other sequencing orders can be achieved by changing the communications address entered in **Options 24.1-24.3**.

Note: Communications addresses should be changed while the boilers are not in sequencing (more than one boiler on) so as not to disrupt operation.

Option 24.4 – Lead OFF Time LV1

DEFAULT 0 (after June 2011)

NOTE: MUST BE SET TO 3 MINUTES (3) OR GREATER FOR PROPER OPERATION.

This option allows the lead boiler to remain in control of all lags up to 999 minutes after the lead is turned off. This may be useful during low water testing or if the burner is recycled for some reason. This is especially useful on low pressure steam boilers.

Option 24.5 – Lead (master) Boiler Select Method LV1

This option parameter selects the lead (master) boiler via the keypad, digital input or communications (Comfire 2). The values are:

0 = Not lead, operates on own PID or as commanded by master (lead)

1 to 3 makes lag boilers modulate to their own setpoint 1 PID when commanded to be ON as follows:

1 = lead (master) via Keypad

NOTE: On newer NX610 Keypads, press and hold the Data key for 5 seconds, then move cursor to for right. The word “lead” in lower case indicates the keypad has this boiler set to lag. Pressing the Com key will cause the “lead” to switch to upper case “LEAD”. This indicates the boiler is now Lead via Keypad. Pressing the Data key return you to the normal screen.

2 = lead (master) via digital input. **(Digital Input Selected via Option 20.8)**

3 = lead (master) via communications such as Comfire 2.

4 - Not a lead boiler (lag only) - Same as setting "0"

5 to 7 makes lag boilers modulate in unison with the lead when commanded to be ON as follows

5 = lead (master) via Keypad as above.

6 = lead (master) via digital input. **(Digital Input Selected via Option 20.8)**

7 = lead (master) via communications such as Comfire 2.

Note: When a lead (master) boiler is deselected as lead (master) and Option 24.0 has not been changed to 0, the boiler remains as lead (master) until a new lead (master) takes control. Once the new lead (master) takes control, the previous lead (master) may be turned off based on the demand and Option 24.1-24.3 settings.



Option 24.6 – lag (slave) On Rate (0-100%) LV1

This value determines the firing rate of the lead (master) boiler at which the first and all subsequent slave(s) (lag) boilers come on. The slave(s) (lag) boiler(s) will be delayed in coming on by the time set in **Option parameter 24.7**. At this point, the lead (master) and the last "lag on" will begin to modulate in unison. If the lead (master) and modulate above this point, the next, as determined by priority number (**Option 24.1, 24.2, 24.3**), will be turned on. When more than one boiler is on, the master and last slave will modulate in unison while the other slaves modulate on their own PID,

Option 24.7 – lag (slave) On Delay (0-999 minutes) LV1

This option sets the time delay between the modulation rate of the lead (master) boiler (and last boiler on if any) exceeding the value set in **Option 24.6** and the next being turned on.

This time may also include additional time as set in **Option 25.6**.

Option 24.8 – lag (slave) Off Rate (0-100%) LV3

When the lead (master) boiler and last boiler modulate below this modulation rate and exceed the value set in **Option 24.9**, the last turned on will be turned off. At this point, the lead (master) and the previous (if any) lag turned on will begin to modulate in unison until they together are below this setting. This will continue until only the lead (master) boiler remains on.

Option 24.9 – lag (slave) Off Delay (0-999 minutes) LV3

This option sets the time delay between the modulation rate is at or below the value set in **Option 24.8** and the last turned on being turned off. This also sets the time delay between successive slaves (lag) being turned off should the modulation rate stay below the setting in **Option 24.8**.

Option 25.0 – Banking based on temperature / water temperature standby for steam boiler LV3

This option sets which input will be used and the 4-20mA current input from the temperature sensor must be connected into one of the 5 possible current inputs:

- 0 = lag banking on temperature is not enabled.
- 1 = uses analog input 1 (PB8 to PA5 input)
- 2 = uses analog input 2 (PB8 to PA6 input)
- 3 = uses analog input 3 (PB8 to PA7 input)
- 4 = uses analog input 4 (PB8 to PA8 input)
- 5 = uses analog input 5 (PA12 supply to PA13 input)

NOTE - If a loop-powered sensor is used, the "+" to the sensor is taken from PB8/PA12 ("sensor supply", JP3 must be set to the "30V" position) and the "-" from the sensor is connected to PA5, PA6, PA7, PA8 or PA13 depending on which input number is to be used. If the temperature sensor gives a current feedback that is out of range, i.e. Less than 3.5mA or greater than 21mA, lag banking on temperature will be cancelled and the sequence lag boiler will bank based on steam pressure.



The following option parameters are only visible if option 25.0 is non-zero:

Option 25.1 – Water temperature zero value LV3

Sets the zero value for the 4-20mA input (usually 0 for a 0-xxx degree temperature sensor).

Option 25.2 – Water temperature span value LV3

Sets the span value for the 4-20mA input (i.e. the sensor range xxx).

Option 25.3 – Water temperature cut-in LV1

Sets the low banking cut-in temperature.

Option 25.4 – Water temperature cut-out LV1

Sets the high banking cut-out temperature.

Option 25.5 – Temperature based warming limit LV1

This works independently and in addition to the normal warming limit. If a non-zero value is entered in 25.5, the burner will also hold at low fire, if the temperature drops below this limit.

Option 25.6 – Lag wait time LV1

This option allows for additional time to be added before a second or third lag is started. This allows the previous lag time to contribute to the lead before adding another lag.

Option 28.0 – Analog Input decimals (0-2) LV3

(Option 28.x is available on Firmware Version 1.204 and above (EK56))

Set the number of decimal places for analog input 1 on PA5-PA11.

Option 28.1 – Analog Input 1 zero (0-999) LV3

Set the number to be displayed when the input 1 current is 4mA.

Option 28.2 – Analog Input 1 span (0-999) LV3

Set the number to be displayed when the input 1 current is 20mA. Setting this parameter to a non-zero value also enables this item.

NOTE: Setting the span value enables the item.

On the 2-line display the values can then be seen by scrolling with the <> keys in RUN mode. They will always show up as “Analog Input 1” or “Analog Input 2” or “Analog Input 3”

On the touchscreen, the analog inputs appear on the right hand side list and can be added to the trends chart, etc. Also the touchscreen gives us the flexibility to type in text to name these inputs like the profiles can be (see screen configuration page on the touchscreen).

Option 28.3 – Analog Input 2 decimals (0-2) LV3

Set the number of decimal places for analog input 2 on PA6-PA11.

Option 28.4 – Analog Input 2 zero (0-999) LV3

Set the number to be displayed when the input 2 current is 4mA.

Option 28.5 – Analog Input 2 span (0-999) LV3

Set the number to be displayed when the input 2 current is 20mA. Setting this parameter to a non-zero value also enables this item. See NOTE under Option 28.2.

Option 28.6 – Analog Input 3 decimals (0-2) LV3

Set the number of decimal places for analog input 3 on PA7-PA11.



Option 28.7 – Analog Input 3 zero (0-999) LV3

Set the number to be displayed when the input 3 current is 4mA.

Option 28.8 – Analog Input 3 span (0-999) LV3

Set the number to be displayed when the input 3 current is 20mA. Setting this parameter to a non-zero value also enables this item. See NOTE under Option 28.2.

Option 29.0 – 4-20mA Output 1 function if not VSD LV3

Set this option to a value from the table below to enable an analog output to re-transmit system variables as a 4-20mA signal.

For example, if this output is to represent Flue Gas Temperature, then set a value of 22.

If this output has been assigned for VSD control in option 3.x, then this setting will be ignored.

Option 29.0, 29.3 and 29.6 function list:			
Value	Function	Value	Function
0	Drive 0 Position	20	Spare
1	Drive 1 Position	21	Boiler operating Setpoint
2	Drive 2 Position	22	Flue gas temperature
3	Drive 3 Position	23	Spare
4	Drive 4 Position	24	Spare
5	Drive 5 Position	25	Spare
6	Drive 6 Position	26	Spare
7	Drive 7 Position	27	Spare
8	Drive 8 Position	28	Spare
9	Drive 9 Position	29	Spare
10	Spare	30	Burner modulation rate
11	Spare	31	Spare
12	Measured value	32	Spare
13	Boiler Efficiency	33	Spare
14	Inlet air temperature	34	Spare
15	Flue gas oxygen level	35	Gas pressure
16	Calculated flue gas CO2 level	36	Spare
17	Spare	37	Flame signal
18	Spare	38	Spare
19	Spare	39	Spare

Option 29.1 – Output1 zero value (4mA output) LV3

Set this option to the value which a 4mA output represents. Often this will be zero, but non zero values may be used. For example, a value of 100 may be better suited for a minimum Flue Gas Temperature to ensure best resolution.

If this output has been assigned for VSD control in option 3.x, then this setting will be ignored.

Option 29.2 – Output1 span value (20mA output) LV3

Set this option to the value which a 20mA output will represent. For example, value of 200 may be better suited for a maximum Flue Gas Temperature to ensure best resolution.

If this output has been assigned for VSD control in option 3.x, then this setting will be ignored.

Option 29.3 – 4-20mA Output 2 function if not VSD LV3

Set this option to a value from the table in 29.0 to enable an analog output to re-transmit system variables as a 4-20mA signal.

If this output has been assigned for VSD control in option 3.x, then this setting will be ignored.

Option 29.4 – Output2 zero value (4mA output) LV3

Set this option to the value which a 4mA output will represent. Often this will be zero, but non zero values may be used.

If this output has been assigned for VSD control in option 3.x, then this setting will be ignored.

Option 29.5 – Output2 span value (20mA output) LV3

Set this option to the value which a 20mA output will represent.

If this output has been assigned for VSD control in option 3.x, then this setting will be ignored.

Option 29.6 – 4-20mA Output 3 function if not VSD LV3

Set this option to a value from the table in 29.0 to enable an analog output to re-transmit system variables as a 4-20mA signal.

Option 29.7 – Output3 zero value (4mA output) LV3

Set this option to the value which a 4mA output will represent. Often this will be zero, but non zero values may be used.

Option 29.8 – Output3 span value (20mA output) LV3

Set this option to the value which a 20mA output will represent.

Commissioning Oxygen Trim**CAUTION**

- Use extreme care when entering flow values and oxygen setpoints. Incorrect setting of either could cause a hazardous situation to occur.
- If the flow values and oxygen setpoints have been up-loaded it is essential that the combustion is verified at each firing position to ensure a hazardous condition cannot occur.
- If using automatic oxygen trim commissioning it is the sole responsibility of the commissioning engineer to ensure the values calculated by the system are correct and will not cause a hazardous condition to occur.
- Once the oxygen trim is commissioned the trim flow limit must be set to ensure a fault in the oxygen trim will not cause a hazardous condition to occur.

In order for the oxygen trim system to function correctly, the following information must be entered:

1. Enter the appropriate option parameters from 30.0 to 42.6 as required.

With the burner off, enter commission mode (See section 5). To get the trim operational it is only necessary to address all option parameters with the **O 2**  symbol

Refer to options 30.0 thru 42.6 inclusive for details of parameters that may be entered.

2. Flow values and O2 setpoints. The flow and O2 values may be entered manually by the engineer (option 34.5), or the system can automatically calculate the values and enter them itself by using automatic trim commissioning (option 30.9).

If the automatic trim commissioning is performed, the engineer **MUST CHECK THAT THE VALUES ENTERED ARE VALID AND SAFE AFTER COMPLETION**. Additionally, the oxygen probe calibration should be checked before and after the procedure since the results depend highly upon measurements taken using the probe.

Before proceeding to enter the oxygen setpoints for each profile, a few points relating to the oxygen trim option should be considered.

- ◆ No trim is applied which would require a drive to move above its high fire position or below its low fire position.
- ◆ The flow for each profile position must be entered to ensure correct operation. The flow can either be measured for each profile position or calculated as a percentage with respect to the flow at high fire.

Using adjust ratio mode to modify and existing oxygen profile manually, follow steps 1 -12 listed below.



CAUTION

When using the adjust ratio mode, it is not possible for the unit to check drive positions at all times. It is the responsibility of the engineer to check that motors and valves are responding correctly

To adjust an oxygen setpoint or enter an air flow value in the firing range, use the following procedure. The manual calculation of the values to be entered here is covered in the next section.

1. Enter adjust ratio mode (See section 5.6).
2. Ensure oxygen trim is set to monitor only 30.5 = 0.
3. Use the scroll keys to select the desired setpoint and move up and/or down (A4 for example). The system will modulate to the selected setpoint and the number displayed will flash to indicate that the drives are modulating.
4. Wait for the number in the display to be illuminated steadily. This means that the drives have arrived at the selected setpoint.
5. The display will allow scrolling sideways to show flow and 'O2' in addition to the servo-motor positions to indicate that the system is expecting a flow value and an oxygen setpoint to be entered for the current profile setpoint. **To check the current oxygen measured value use the engineer's key EK44.**
6. Once the oxygen value is shown on the display use the scroll keys to position the '>' pointing to the 'O2' value use the UP/DOWN keys to adjust the oxygen setpoint as necessary. The display will start flashing to indicate that a change has been made.

7. If the new oxygen setpoint value is wanted, press the ENTER key. The value will be stored in memory.
8. If the new oxygen setpoint value is not wanted or an adjustment is not required, press the **NEXT** key to return to the value stored in memory.
9. Once the flow value is shown on the display use the scroll keys to position the '>' pointing to the 'FLO' value use the UP/DOWN keys to adjust the flow value as necessary. The display will show the air flow value, represented as a percentage of the air flow when the drives are at the **HIGH FIRE** position. The display will start flashing to indicate that a change has been made.
10. If the new flow value is not wanted or an adjustment is not required, press the **NEXT** key to return to the value stored in memory.
11. If it is necessary to adjust another setpoint in the firing range, repeat the above procedure from step 3.
12. After modifying an existing O2 trim profile, use Option 30.8 to reset the feed forward function. See option 30.8 for details.

	O 2
--	------------

 **Option 30.0 – Oxygen probe interface serial number LV3**

Each CANbus device connected to the system has a unique serial number allocated to it during production testing. This number cannot be changed and is used to uniquely identify each device.

When the system is in commissioning mode the serial number of all the connected devices is read by the PPC6000 and displayed as a 'list' to allow the selection of the relevant serial number unit to be made.

Scrolling the list in an upward direction will scroll through all oxygen probe interface options available until '0, nothing' is displayed. Enter this value to disconnect the specified device from any hardware.

Scrolling the list in a downward direction will stop when the currently selected item is displayed, and the value will stop flashing.

The display will show type information for each device present (such as 'O2 probe'), but the commissioning engineer should be aware of which serial number device is being used for which function.

	O 2
--	------------

 **Option 30.1 - Oxygen probe calibration offset value (0 – 999) LV3**

This option parameter is only available if option 30.0 is non-zero.

This option parameter must be set to the calibration offset value that is specified with the Fireeye probe supplied.

When using another manufacturer's O2 probe with a 4-20mA signal for O2 value, enter the O2 value for 4.0mA in this option parameter. Example 0% O2 = 000.

O 2 → **Option 30.2 - Oxygen probe calibration gain value (0 – 999) LV3**

This option parameter is only available if option 30.0 is non-zero.

This option parameter must be set to the calibration gain value that is specified with the Fireeye probe supplied.

When using another manufacturer's O2 probe with a 4-20mA signal for the O2 value, enter the O2 value for 20.0mA in this option parameter. Example 21% O2 = 210.

NOTE: If the value of 30.1 and 30.2 are both below 300, the PPC6000 will utilize the analog input on the NXO2INT terminals PL6 (+), PL7(-) to determine the O2 signal.

Option 30.3 - Oxygen probe calibration gas concentration (0.00 – 9.99%) LV3

This option parameter is only available if option 30.0 is non-zero.

This option parameter must be set to the percentage oxygen concentration of the calibration gas used if the probe is to be calibrated using a reference gas (see option parameter 30.6). The range of this parameter is 0.00 - 9.99%.

O 2 → **Option 30.4 – Flue and inlet sensor temperature units (0 – 1) LV3**

This option parameter is only available if option 30.0 is non zero.

This option parameter must be set to select the units for display of both temperatures on either °C or °F.

Option parameter 30.4 value	Meaning
0	°C. The temperature value will be displayed in °C.
1	°F. The temperature value will be displayed in °F.

Please note that temperature limits **MUST** be set in the correct units.

If a 4-20mA input is used for O2 signal, a NXIATS is required to calculate efficiency in conjunction with a K type thermocouple measuring flue temperature, connected to the appropriate inputs in the NXO2INT.

O 2 → **Option 30.5 - Oxygen input function (0/1) LV3**

This option parameter can only be set above 1 if option 30.0 is non zero.

Using this option parameter, it is possible to configure the oxygen input for a monitoring function or trim function. The two functions are explained below:

Option parameter 30.5 value	Meaning
0	Monitor only. The oxygen value is only used to provide a display of the measured oxygen level.
1	Closed loop trim. The oxygen value is used to provide both a display of the measured oxygen level and a feedback signal for closed loop trim control function of the PPC6000 series control.

Option 30.6 - Oxygen probe calibrate enable (0 – 2) LV3

This option parameter is only available if option 30.0 is non-zero.

This option parameter must be used when calibrating the oxygen probe.
There are three possible values:

Option parameter 30.6 value	Meaning
0	No calibrate. This is the normal operating condition, where the probe is used to measure the oxygen concentration in the flue.
1	Calibrate in air. The probe will be calibrated for 'offset' at the normal atmospheric oxygen concentration.
2	Calibrate in reference gas. The probe will be calibrated for 'gain' in a reference gas with a nominal oxygen concentration the level specified in option parameter 30.3 (typically 3.0%).

Once this calibration has been successfully completed the values in 30.1 and 30.2 will be automatically updated.

O 2 → **Option 30.7 - Boiler transport delay (5 – 60 seconds) LV3**

Boiler transport delay is the time taken for 'gas' to travel from the burner to the oxygen probe. This delay varies with burner fire rate.

In order for the oxygen trim control loop to be stable, this parameter must be set accurately to the transport delay of the boiler **when at low fire**. This option may be set between **5** and **60** seconds inclusive.

- To measure the transport delay, ignite the burner and enter adjust ratio mode. Select the low fire setpoint and allow time for the flue oxygen reading to settle. Once the oxygen reading is steady, make a step change to the fuel/air ratio and start a timer. As soon as the measured oxygen reading **begins** to change, stop the timer. Set the option parameter to the recorded timer value in seconds.
- Automatic trim commissioning (option 30.9) will attempt to set this automatically. However the value must be checked by the engineer.

Option 30.8 - Reset oxygen trim profile (0/1) LV3

During full automatic operation, the O2 trim system will learn and store the percentage of trim applied to various firing rates. This provides a "feed forward" aspect to O2 trim. If any changes to target O2 values are made after the system has been in operation, the trim profile must be reset so as to not apply previous trim feed forward. A new trim profile will be learned as the burner modulates. Only the trim profile is affected. The Oxygen setpoints and flow values are not changed.

This option parameter allows the learned trim profile to be reset. If the option is set to 1 any learned profile currently held in memory will be reset and the trim drives will return to their commissioned positions for the corresponding modulation position. Once the profile has been reset this option parameter will automatically be reset to 0.

Option 30.9 – Automatic trim commissioning (0 / 1) LV3



The unit is able to automate the manual calculation procedures (option parameter 34.5), automatically calculating and entering flow values, oxygen trim setpoints, and boiler transport delay. The automatic commissioning procedure will only work if the following conditions are met:

- Option parameter 30.9 (automatic trim commissioning) is set to 1
- An oxygen probe is fitted and fully operational
- The unit is in adjust ratio with the burner firing a single fuel only
- A hydrocarbon ratio has been entered for the current fuel (see option parameters 35.1 — 35.4).

The auto commissioning procedure will usually take between 10 and 30 minutes (depending on number of setpoints), and is performed by the unit as follows:

1. Beginning with high fire, the unit moves the drives to each point in the firing range. **The display will show O2.**
2. When the measured oxygen reading settles, the unit stores the measured oxygen reading as the new oxygen setpoint.
3. The drives are moved to the next position directly below high fire (Ph-1) and wait for the oxygen to stabilize.
4. The unit moves the air drives up to the point above the current setpoint, leaving the fuel drive in the same position. **The display will show 'Flow calc An + 1'.**
5. When the new oxygen reading settles, the unit calculates and stores the new flow value. If the oxygen reading exceeds 15.0% during this stage, the unit shuts the burner down with F77.
6. When the unit has completed the low fire point, the measured boiler transport delay (at low fire) is stored in option parameter 30.7. Option parameter 30.5 (oxygen trim enable) is set to zero.
7. **IMPORTANT:** You must use "adjust ratio" mode to confirm each position from P3 (low fire) to Ph (high fire). If the flow values appear reasonable (about 4 to 6% change at each position) once you have finished, setting option 30.5 to 1 will enable O2 trim. There is a one-minute delay after exiting commissioning mode before trim will enable. If the flow values are unreasonable, they may be adjusted manually by placing the cursor to the "FLO" position and using the up/down arrows set the desired flow value. Using EK44 verify the O2 levels at each position and adjust to match if required. EK46 will help troubleshoot O2 trim issues.

BEFORE ENABLING TRIM, USE ADJUST RATIO MODE TO MANUALLY CHECK THE CALCULATED FLOW VALUES, OXYGEN SETPOINTS AND TRANSPORT DELAY. THE LOW FIRE PERCENTAGE FLOW VALUE SHOULD CONFORM APPROXIMATELY TO THE TURN-DOWN RATIO OF THE BURNER.

SUMMARY

To perform automatic trim commissioning, follow the procedure below:

1. If the probe is new, enter the offset and gain values in option parameters 30.1 and 30.2 which are supplied with the probe. To re-calibrate the probe refer to section 8.
2. Enter adjust ratio mode (See section 5).
3. Enable automatic trim commissioning by setting option parameter 30.9 to 1.
4. Wait for procedure to finish.
5. Check that the O₂, flow and transport delay values are sensible. Use EK44 for O2 value.
6. Check calibration of the oxygen probe.



7. Confirm setup using “adjust ratio” mode.

NOTE: If the boiler shuts off for any reason during automatic commissioning, the sequence will continue when the boiler re-starts.

Option parameter 30.9 value	Meaning
0	Not selected.
1	Perform automatic trim characterization. The control will attempt to characterize the burner profile by calculating flow values and selecting oxygen setpoints to match the currently commissioned points. Automatic trim commissioning will be performed under the following conditions: <ul style="list-style-type: none">• An oxygen probe is fitted and fully operational• The control is in adjust ratio mode.• A hydrocarbon ratio has been entered for the current fuel (see option parameters 35.1 – 35.4).

Option 31.0 - Limit Modulation Range (0 to 1) LV3

By default, the control modulates the burner between the set-points P_3 (low fire) and P_h (high fire), where P_h is the last set-point entered in commission ratio mode. If oxygen trim is fitted, it is not possible for any drive position to be trimmed lower than point P_3 (low fire) or higher than point P_h (high fire). Basically, you can't take fuel or air off at low fire, and you can't add fuel or air at high fire.

This option parameter allows the engineer to overcome this limitation in one of two ways. First the modulation range of the burner can be limited so that the burner may only modulate between points P_4 (one set-point above low fire) and P_{h-1} (one set-point below high fire). Since oxygen trim is not affected by this limitation, each drive may be trimmed between the points P_3 and P_h . This means that it is not possible to over-fire or under-fire the burner but a degree of trim may still be achieved at high and low fire. Note that this option may reduce the turn down of the boiler.

Option parameter 31.0 value	Meaning
0	Modulation not limited. Burner modulates from P_3 to P_h . Oxygen trim works over full range from P_3 to P_h , but may not be able to apply trim at high fire, or low fire – depending on trim direction. The burner always modulates to the desired modulation rate, which may limit the system's ability to maintain the desired oxygen value.
1	Normal modulation range limited to P_4 to P_{h-1} always. Oxygen trim works over full range from P_3 to P_h , and can apply extra trim at low and high fire – limited by P_3 and P_h . This setting is useful when there is extra capacity (usually air flow) available for the burner, but otherwise it will reduce the turn-down ratio of the boiler.

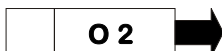

Options 31.1 to 31.4 - Trim Type for profiles 1 to 4 (0 to 2) LV3

These option parameters determine which drive will be trimmed (Air or Fuel) in profiles 1 to 4. These parameters are used together with the parameters entered in option parameters 2.0 to 2.9 to determine which drives are trimmed, and in which direction.

Parameter	Meaning
31.1	Trim Type for profile 1
31.2	Trim Type for profile 2
31.3	Trim Type for profile 3
31.4	Trim Type for profile 4

Parameter value in 31.X	Meaning
0	No Trim. Do not apply oxygen trim when running on this profile.
1	Air Trim. Trim 'Air' drives when running on this profile (see option parameters 2.0 to 2.9.)
2	Fuel Trim. Trim 'Fuel' drives when running on this profile (see option parameters 2.0 to 2.9.)

0 2 → **Option 32.0 - Trim limit default (0/1) LV3**

0 = Default Trim Limit of $\pm 5\%$
 1 = Enables options 32.1 to 32.4

0 2 → **Options 32.1 to 32.4 - Trim limits (0.0 – 25.0) LV3**

Option 32.0 is only available if option 30.5 (oxygen input function) has been set for closed loop oxygen trim. It is possible for the system to trim the air or fuel drives up to a maximum deviation of $\pm 25.0\%$ of the total air or fuel flow for the chosen trim drives.

If option 32.0 is set to 0, the default trim limit will be $\pm 5.0\%$ for all profile selections. Option parameters 32.1 to 32.4 will not be available.

If option 32.0 is set to 1, it is possible to individually adjust the trim limit for each profile selection using option parameters 32.1 to 32.4. The trim limit may be adjusted from 0.0% (no trim) up to a maximum of $\pm 25.0\%$ (maximum allowable trim).

It is the responsibility of the commissioning engineer to ensure the trim limit set will not allow a hazardous combustion condition to occur in the event of an oxygen probe failure. Where oxygen is to be considered safety critical, option parameters 31.X should be used to setup a second oxygen monitor. When a second oxygen monitoring system is used, the oxygen can be considered fail-safe, and the trim limits can be set up to 50% instead of 25%.

0 2 → **Options 33.1 to 33.4 - Trim integral gain (Default 10%) LV3**

Options 33.1 to 33.4 are only available if option 30.5 (oxygen input function) has been set for closed loop oxygen trim.



In order for the oxygen trim control loop to be stable, the integral gain must be set correctly. Options 33.1 to 33.4 allow the integral gain to be set individually for each profile combination to any value between 0.0 and 99.9%. As a general recommendation, the integral gain should be initially set to 10.0%. This value must be set above 0.0 for the system to apply trim.

If the burner is firing, it is only possible to make an adjustment to the option parameter that relates to the selected profile. If the burner is not firing, the integral gain for any profile selection may be adjusted.

Option 34.0 - Trim proportional gain (0/1) LV3

Options 34.1 to 34.4 - Trim proportional gain (0.0 – 99.9%) LV3

Options 34.0 to 34.4 are only available if option 30.5 (oxygen input function) has been set for closed loop oxygen trim.

If oxygen trim proportional gain is not required for any profile selection, set option parameter 34.0 to **0**.

If oxygen trim proportional gain is required, set option parameter 34.0 to **1**. Option parameters 34.1 to 34.4 will then become available. Options 34.1 to 34.4 allow the loop gain to be set individually for each profile selection to any value between 0.0 and 99.9%.

Oxygen trim proportional gain is not normally required.

Option 34.5 - Calculating and entering the flow values manually LV3

If the flow values are to be calculated manually, the procedure below must be followed.

Enter Adjust Ratio Mode with oxygen trim **disabled** as outlined above.

1. Select the high fire position. This will cause the display to show A(n), where n is the number of the high fire profile point.
2. Wait until the oxygen reading has stabilized, the value can be viewed using the engineer's key.
3. Record the **excess air** value at location x in the table. For single fuel profiles, this value may be found using the Engineer's Key parameter EK48 (provided the hydrocarbon ratio has been entered into the appropriate option parameter (35.1 - 35.4) for this fuel). For multiple fuel profiles, **Refer to NOTE under section Options 35.1 to 35.4.**
4. Select the profile position immediately below high fire. This will cause the display to show A(n - 1).
5. Wait until the oxygen reading has stabilized and record the **excess air** value at location a₁ in the table
6. Move air dampers 1 and 2 (if fitted) **up** until they stop, so that they are at the setpoint immediately above the current position. **Do not press enter.**
7. Wait until the oxygen reading has stabilized, then record the **excess air** value at location b₁ in the table, relating to the current profile position



8. Repeat the above for all other profile positions including low fire (profile position A3), recording each time the values at locations a and b in the table. When extra air is added at P3, the time taken before the flue oxygen reading starts to increase should be measured and entered into option parameter 30.7.
9. After completing the table for all Excess Air values a and b, complete the Excess Air + 100 column, by adding 100 (i.e. $y = x + 100$, $c = a + 100$ and $d = b + 100$).
10. Complete the Ratio column by dividing c by d (i.e. $e = c/d$).
11. Complete the Airflow column by multiplying e by the previous value of f (i.e. $f_x = e_x f_{x-1}$).
12. If the system will be applying trim to the fuel, the fuel flow column must be completed. This is achieved by multiplying the airflow at each point by the ratio of excess air + 100 at high fire divided by the excess air + 100 at the actual point (i.e. $g_x = f_x(y/c_x)$).

Example of table completed for A10 (high fire) to A8. In practice, the table must be filled out down to A3 (low fire).

Profile position	Excess Air		Ex. Air + 100 $y = x + 100$ $c = a + 100$ $d = b + 100$		Ratio	Airflow	Fuel flow
	x		y				
High fire = A10	x	10	y	110	-----	99.9%	99.9%
1 = A9	a ₁	8	c ₁	108	$e_1 = c_1/d_1$	$f_1 = e_1 (99.9)$	$g_1 = f_1 (y/c_1)$
	b ₁	33	d ₁	133	0.812	81.1%	82.6%
2 = A8	a ₂	9	c ₂	109	$e_2 = c_2/d_2$	$f_2 = e_2 (f_1)$	$g_2 = f_2 (y/c_2)$
	b ₂	20	d ₂	120	0.908	73.7%	74.4%



Table: Flow calculation table

Profile position	Excess Air		Ex. Air + 100 $y = x + 100$ $c = a + 100$ $d = b + 100$		Ratio	Airflow	Fuel flow
	x		y				
High fire = A	x		y				
1 = A	a ₁ b ₁		c ₁ d ₁		$e_1 = c_1/d_1$	$f_1 = e_1 (99.9)$	$g_1 = f_1 (y/c_1)$
2 = A	a ₂ b ₂		c ₂ d ₂		$e_2 = c_2/d_2$	$f_2 = e_2 (f_1)$	$g_2 = f_2 (y/c_2)$
3 = A	a ₃ b ₃		c ₃ d ₃		$e_3 = c_3/d_3$	$f_3 = e_3 (f_2)$	$g_3 = f_3 (y/c_3)$
4 = A	a ₄ b ₄		c ₄ d ₄		$e_4 = c_4/d_4$	$f_4 = e_4 (f_3)$	$g_4 = f_4 (y/c_4)$
5 = A	a ₅ b ₅		c ₅ d ₅		$e_5 = c_5/d_5$	$f_5 = e_5 (f_4)$	$g_5 = f_5 (y/c_5)$
6 = A	a ₆ b ₆		c ₆ d ₆		$e_6 = c_6/d_6$	$f_6 = e_6 (f_5)$	$g_6 = f_6 (y/c_6)$
7 = A	a ₇ b ₇		c ₇ d ₇		$e_7 = c_7/d_7$	$f_7 = e_7 (f_6)$	$g_7 = f_7 (y/c_7)$
8 = A	a ₈ b ₈		c ₈ d ₈		$e_8 = c_8/d_8$	$f_8 = e_8 (f_7)$	$g_8 = f_8 (y/c_8)$
9 = A	a ₉ b ₉		c ₉ d ₉		$e_9 = c_9/d_9$	$f_9 = e_9 (f_8)$	$g_9 = f_9 (y/c_9)$
10 = A	a ₁₀ b ₁₀		c ₁₀ d ₁₀		$e_{10} = c_{10}/d_{10}$	$f_{10} = e_{10} (f_9)$	$g_{10} = f_{10} (y/c_{10})$
11 = A	a ₁₁ b ₁₁		c ₁₁ d ₁₁		$e_{11} = c_{11}/d_{11}$	$f_{11} = e_{11} (f_{10})$	$g_{11} = f_{11} (y/c_{11})$
12 = A	a ₁₂ b ₁₂		c ₁₂ d ₁₂		$e_{12} = c_{12}/d_{12}$	$f_{12} = e_{12} (f_{11})$	$g_{12} = f_{12} (y/c_{12})$
13 = A	a ₁₃ b ₁₃		c ₁₃ d ₁₃		$e_{13} = c_{13}/d_{13}$	$f_{13} = e_{13} (f_{12})$	$g_{13} = f_{13} (y/c_{13})$
14 = A	a ₁₄ b ₁₄		c ₁₄ d ₁₄		$e_{14} = c_{14}/d_{14}$	$f_{14} = e_{14} (f_{13})$	$g_{14} = f_{14} (y/c_{14})$
15 = A	a ₁₅ b ₁₅		c ₁₅ d ₁₅		$e_{15} = c_{15}/d_{15}$	$f_{15} = e_{15} (f_{14})/15$	$g_{15} = f_{15} (y/c_{15})$
16 = A	a ₁₆ b ₁₆		c ₁₆ d ₁₆		$e_{16} = c_{16}/d_{16}$	$f_{16} = e_{16} (f_{15})$	$g_{16} = f_{16} (y/c_{16})$
17 = A	a ₁₇ b ₁₇		c ₁₇ d ₁₇		$e_{17} = c_{17}/d_{17}$	$f_{17} = e_{17} (f_{16})$	$g_{17} = f_{17} (y/c_{17})$
18 = A	a ₁₈ b ₁₈		c ₁₈ d ₁₈		$e_{18} = c_{18}/d_{18}$	$f_{18} = e_{18} (f_{17})$	$g_{18} = f_{18} (y/c_{18})$
19 = A	a ₁₉ b ₁₉		c ₁₉ d ₁₉		$e_{19} = c_{19}/d_{19}$	$f_{19} = e_{19} (f_{18})$	$g_{19} = f_{19} (y/c_{19})$
20 = A	a ₂₀ b ₂₀		c ₂₀ d ₂₀		$E_{20} = c_{20}/d_{20}$	$f_{20} = e_{20} (f_{19})$	$g_{20} = f_{20} (y/c_{20})$

NOTE: For the following Options 35.x, see procedure in Section 9.5.

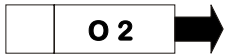

Option 35.0 – Inlet temperature sensor serial number LV3

Each CANbus device connected to the system has a unique serial number allocated to it during production testing. This number cannot be changed and is used to uniquely identify each device.

When the system is in commissioning mode the serial number of all the connected devices is read by the PPC6000 and displayed as a 'list' to allow the selection of the relevant serial number unit to be made.

Scrolling the list in an upward direction will scroll through all temperature sensor options available until '0, nothing' is displayed. Enter this value to disconnect the specified device from any hardware.

Scrolling the list in a downward direction will stop when the currently selected item is displayed, and the value will stop flashing.

The display will show type information for each device present (such as 'air temp'), but the commissioning engineer should be aware of which serial number device is being used for which function.

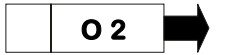

Options 35.1 to 35.4-Hydrocarbon ratios of each fuel respectively (0.00 – 9.99) LV3

If a display of calculated burner efficiency, or 'automatic trim commissioning' is required, the hydrocarbon ratios for the required fuels must be entered. These may be set between **0.0** and **9.99** inclusive, where the value entered is the hydrocarbon ratio x 10. For example, for a hydrocarbon ratio of 0.157, a value of **1.57** should be entered.

Note: When firing multiple fuels, the mixture between the fuels fired may vary across the firing range of the burner. When this happens, the effective hydrocarbon ratio and calorific value of the fuel combination will change. The accuracy of the calculated efficiency and the 'automatic trim commissioning' procedure will be adversely affected by this. It maybe that these functions should not be used, in which case these values should be entered as zero.

See Option Table 35.x A on page 119.

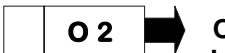

Options 35.5 to 35.8-Calorific values of fuels/profiles 1 to 4 respectively (0.0 – 99.9) LV3

These option parameters are only available if option 35.0 (inlet temperature sensor) is not set to zero.

If a display of calculated burner efficiency is required, the calorific value of the required fuels must be entered. May be set between **0.0** and **99.9 MJkg⁻¹** inclusive.

Note: When firing multiple fuels, the mixture between the fuels fired may vary across the firing range of the burner. When this happens, the effective hydrocarbon ratio and calorific value of the fuel combination will change. The accuracy of the calculated efficiency and the 'automatic trim commissioning' procedure will be adversely affected by this. It maybe that these functions should not be used, in which case these values should be entered as zero.

The following table shows the calorific values and hydrocarbon ratios of several common fuels. These values should be used as a guide only. If the display is required to show gross efficiency in addition to entering the gross calorific values a non zero value for the boiler radiated heat loss **MUST** be entered.

See Option Table 35.x A on page 119.

Option Table 35.x A

Fuel	Gross calorific value	Net calorific value	Hydrocarbon ratio (x10)
Gas	52.8	47.6	3.20
Light oil	45.6	42.8	1.57
Medium oil	43.1	40.8	1.35
Heavy oil	42.9	40.5	1.28

0 2 → Option 35.9 - Boiler radiated heat loss (0.0 – 9.9%) LV3

This option parameter is only available if option 35.0 (inlet temperature sensor) is not set to zero.

If this option parameter is set to zero the unit will calculate the net efficiency, if non-zero it will calculate gross efficiency.

For accurate calculation of boiler gross efficiency, this option parameter must be set to the value of the heat lost through the shell of the boiler at high fire as a percentage of the burner's output at high fire. The range of this parameter is **0.0** to **9.9%**.

Option 36.0 - Flue temperature alarm select (0/1) LV3

This option parameter is only available if option 30.0 is non zero.

If option 36.0 is set to **0**, the flue temperature high and low alarms are disabled.

If option 36.0 is set to **1**, the flue temperature high and low alarms are enabled and option parameters 36.1 to 36.4 and 37.1 to 37.4 become available.

Options 36.1 to 36.4 - Flue temperature low alarm values (0 – 999) LV3

Using option parameters 36.1 to 36.4, it is possible to set a different flue temperature low alarm value for each profile combination. Each option parameter may be set to any value between **0** and **999** inclusive. The temperature units should be set with respect to option parameter 30.4.

If the burner is firing, it is only possible to make an adjustment to the option parameter that relates to the selected profile. If the burner is not firing, the low alarm value for any profile selection may be adjusted.

When the flue temperature drops below the low alarm value for the selected profile, a fault number will appear.

Options 37.1 to 37.4 - Flue temperature high alarm values (0 – 999) LV3

Using option parameters 37.1 to 37.4, it is possible to set a different flue temperature high alarm value for each profile selection. Each option parameter may be set to any value between **0** and **999** inclusive. The temperature units should be set with respect to option parameter 30.4.

If the burner is firing, it is only possible to make an adjustment to the option parameter that relates to the selected profile. If the burner is not firing, the high alarm value for any profile selection may be adjusted.

When the flue temperature rises above the high alarm value for the selected profile combination, a fault number will appear.

O 2 → **Option 38.0 - Oxygen alarm select (0 – 2) LV3**



CAUTION

This parameter is not required, but *highly recommended*.

Option parameter 38.0 is only available when option 30.5 (oxygen input select) is not set to zero and the optional oxygen probe interface unit is connected.

Since the oxygen alarm values relate to the oxygen setpoint values, oxygen setpoint values must first be entered in adjust ratio mode.

Option parameter 38.0 value	Meaning
0	Alarms disabled. Oxygen low and high alarms are disabled.
1	Alarms enabled, no non-volatile lockout. Oxygen low and high alarms are enabled and option parameters 38.1 to 41.4 will become available. If an alarm value is exceeded, a fault number will appear but no non-volatile lockout will occur.
2	Alarms enabled with non-volatile lockout. Oxygen low and high alarms are enabled and option parameters 38.1 to 41.4 will become available. If an alarm value is exceeded, a fault number will appear and a non-volatile lockout will occur.

O 2 → **Options 38.1 to 38.4 - Oxygen low alarm values at low fire (0.0 – 99.9%) LV3**

O 2 → **Options 39.1 to 39.4 - Oxygen low alarm values at high fire (0.0 – 99.9%) LV3**

O 2 → **Options 40.1 to 40.4 - Oxygen high alarm values at low fire (0.0 – 99.9%) LV3**

O 2 → **Options 41.1 to 41.4 - Oxygen high alarm values at high fire (0.0 – 99.9%) LV3**

Using option parameters 38.1 to 41.4, it is possible to set different oxygen alarm values at high fire and low fire for each profile.

At firing positions other than high and low fire, the alarm limit is interpolated between the two points. For example, if the oxygen limit has been entered as 5% of setpoint at low fire and 10% of setpoint at high fire, the limit at mid fire will be 7.5%.



The alarm limits may be set to any value between **0.0** and **99.9%**, where the value entered relates to a **percentage deviation** from each oxygen setpoint in the firing range.

If the burner is firing, it is only possible to make an adjustment to the option parameters that relate to the selected profile. If the burner is not firing, the alarm values for any profile selection may be adjusted.

An oxygen low alarm will be caused by one or more of the following events:

- The level drops below 0.5% O₂ for 30 seconds
- The level drops below the low alarm limit for 2 minutes
- The level drops below **twice** the low alarm limit for 30 seconds

An oxygen high alarm will be caused by one or more of the following events:

- The level rises above the high alarm limit for 2 minutes
- The level rises above **twice** the high alarm limit for 30 seconds

When 2 probes the low alarm will also be caused by the following event:

- The difference between the oxygen values exceeds the value set in option parameter 42.4 for 2 minutes

Option 42.0 – Second Oxygen probe interface serial number LV3

Each CANbus device connected to the system has a unique serial number allocated to it during production testing. This number cannot be changed and is used to uniquely identify each device.

When the system is in commissioning mode the serial number of all the connected devices is read by the PPC6000 and displayed as a 'list' to allow the selection of the relevant serial number unit to be made.

Scrolling the list in an upward direction will scroll through all oxygen probe interface options available until '0, nothing' is displayed. Enter this value to disconnect the specified device from any hardware.

The FIREYE oxygen probe and associated electronics are not fail-safe. It is for this reason that the maximum amount of oxygen trim allowed must be limited by the commissioning engineer using option parameters 32.1 to 32.4. The trim must be limited to ensure that in the event of a probe fault (incorrect O₂ level), the combustion does not become unsafe.

For applications demanding large amounts of oxygen trim to be applied, or where oxygen monitoring is especially critical, a second oxygen probe and controller can be selected here. The two oxygen readings from the probes can be compared when the burner is running to provide fail-safe oxygen monitoring.

Option 42.1 – Second Oxygen probe calibration offset value (0 – 999) LV3

This option parameter is only available if option 31.0 is non-zero.

This option parameter must be set to the calibration offset value that is specified with the probe supplied.

Option 42.2 – Second Oxygen probe calibration gain value (0 – 999) LV3



This option parameter is only available if option 31.0 is non-zero.

This option parameter must be set to the calibration gain value that is specified with the probe supplied.

Option 42.3 – Second Oxygen probe calibrate enable (0 – 2) LV3

This option parameter is only available if option 31.0 is non-zero.

This option parameter must be used when calibrating the second FIREYE oxygen probe. There are three possible values, as seen on the following chart:

Option parameter 31.3 value	Meaning
0	No calibrate. This is the normal operating condition, where the probe is used to measure the oxygen concentration in the flue.
1	Calibrate in air. The probe will be calibrated for 'offset' at the normal atmospheric oxygen concentration.
2	Calibrate in reference gas. The probe will be calibrated for 'gain' in a reference gas with a nominal oxygen concentration the level specified in option parameter 30.3 (typically 3.0%).

Once this calibration has been successfully completed the values in 31.1 and 31.2 will be automatically updated.

Option 42.4 – Max oxygen variation (0 – 9.9 %) LV3

Where the second oxygen probe is being used as a cross-check on the first one, the maximum permitted variation between the two oxygen readings should be entered here. It is suggested that a value of around 0.5 % be used, but the application may demand a higher setting if the two probes are not in exactly the same part of the flue. The control will lockout within 30 seconds of the two oxygen readings being outside the specified window.

When this parameter is non-zero, the flue oxygen limits will be checked on a 'worst case' basis. This means that the low oxygen limit (see options 38.X, 39.X) is checked against the lower of the two oxygen probe readings, and the high oxygen limit (see options 40.X, 41.X) is checked against the higher of the two oxygen probe readings. If there is a fault with second oxygen probe, the burner will also lockout.

If this parameter is left at zero (0.0) no checking will be done, but the oxygen and temperatures associated with second oxygen probe will still be available on the engineers key (EK75-79).

Note: When fail-safe oxygen monitoring is employed using two probes, each probe must be tested and calibrated at intervals not less frequent that once every six months.



Option 42.5 – Max flue temp variation (0 to 999 °C) LV3

If non-zero, the burner will lockout if the two oxygen probes vary by more that this many degrees (Celsius). This can be used in applications where flue temperature is especially critical.

Option 42.7 – Air pressure monitoring* – input number LV3

Available on firmware version 1.3 onwards (EK56).

Option 42.8 – Air pressure monitoring* – Span LV3

Option 42.9 – Air pressure monitoring* – max error LV3

* For options 42.7, 42.8, 42.9 - EK98 shows air pressure error if in RUN and MODULATION only. If not modulating or in a commission mode, it shows the actual pressure value otherwise it can't be seen on the NX610 display in commission mode. Air pressure will show as a display value on the NX610 display and on the touchscreen if updated to 1.039 or later. Currently air pressure setpoints cannot be seen in the profile tables in comfire or on the touchscreen.

Option 43.0 – Water level / expansion unit LV3 - Reserved**

Option 43.1 – Water level / expansion unit LV3 - Reserved**

* For options 43.0 and 43.1 - Firmware 1.039 or later.

Option 44.0 - Set real time clock (0/1) LV1

Setting this option 1 enables the user to set the clock in the control used for fault logging. First set this option to 1 then adjust the options 49.1 to 49.6. When these are correct, check that this option is still at 1, then press the RUN key then the ENTER key.

Option 44.1 – Set Year (00 – 99) LV1

See “SET CLOCK” Example after Option 44.7

Option 44.2 – Set Month (1 – 12) LV1

See “SET CLOCK” Example after Option 44.7

Option 44.3 – Set Day of Month (1 – 31) LV1

See “SET CLOCK” Example after Option 44.7



Option 44.4 – Set Day of Week (1 - 7) LV1

For reference 1=Sunday, 2=Monday through 7=Saturday
See “SET CLOCK” Example after Option 44.7

Option 44.5 – Set Hours (0 - 23) LV1

Hours use 24 hour format. AM= 0-11, PM=12-23; For reference 0=midnight, 12=noon, 18= 6 pm (12+6)
See “SET CLOCK” Example after Option 44.7

Option 44.6 – Set Minutes (0 - 59) LV1

See “SET CLOCK” Example after Option 44.7

Option 44.7 – Set Seconds (0 - 59) LV1

See “SET CLOCK” Example after Option 44.7

“SET CLOCK” EXAMPLE	
To Set 6:30:45, PM, Tuesday, December, 25, 2007	
The Values should be entered as follows:	
44.1 = 7	(Year)
44.2 = 12	(Month)
44.3 = 25	(Day of Month)
44.4 = 3	(Day of Week)
44.5 = 18	(Hours) (12+6)
44.6 = 30	(Minutes)
44.7 = 45	(Seconds)

Option 44.9 – Reset Fault Log (0 - 1) LV3

This option clears the current the fault history.
Set the option parameter to 1, then press RUN, than ENTER. The control will erase the fault history and return to run mode.

Option 45.0 - Erase / Restore enable (0 - 1) LV3



CAUTION

- If this value is displayed as a '2', the option parameter data has been 'uploaded' into the control, ensure all option parameters are set to match the requirements of the burner to which it is connected. Failure to do so could cause a hazardous condition to occur.
- After all option parameters have been checked to match the requirements of the burner to which it is connected, reset this option parameter to zero to allow the system to operate.
- If an attempt is made to operate the system with this option parameter set to '2' a fault will be generated and the control will perform a non-volatile lockout, preventing the burner from firing.

In order to erase information in memory for a specific profile selection (see option parameter 45.1), this option must be set to '1'. Once the control has left set-up mode, this parameter will automatically be reset to '0'. In order to restore information to the control from the back-up held in the display (see option parameter 45.2), this option must be set to a '1'. Once the control has left set-up mode, this parameter will automatically be reset to '0'.

If this option parameter is set to '2' see caution message above.

Option 45.1 - Erase command (0 - 5) LV3

When erase enable (option 45.0) is set to '1', this option parameter determines which information will be erased when the control leaves option set mode.

- 0 - No erase.
- 1 - Erase profile 1.
- 2 - Erase profile 2.
- 3 - Erase profile 3.
- 4 - Erase profile 4.
- 5 - Erase all setpoints and initialize all option parameters.

If 5 is selected, **all profile setpoints will be erased and all option parameters will be set to default values.** The control will be initialized to the same state as when it was shipped.

NOTE: You must exit commissioning mode to begin the erase.

Option 45.2 - Restore command (0 - 999) LV3

MEMORY TEST: To determine if the NX610 keypad display contains a valid memory, press both left and right cursor (arrow) keys simultaneously. The display will change to LOCAL MODE and toggle between two information screens. One of these will contain the capitol letters FL CDBKP. If all “_ _ _ _” appear, there is no valid memory in the display. If no valid option parameter and profile is available from previous downloads using Comfire 2 software, all data and combustion curves will need to be entered by hand. Please refer to Fireeye bulletin NEX-1502 (Comfire 2), available at www.Fireeye.com. Comfire 2 will not restore the servomotor serial numbers which will need to be hand entered in Option 3.0 to 3.9 **BEFORE** restarting the PPC6000. A valid backup is achieved after the burner has been running in “AUTO” for approximately 20 minutes.

When erase / restore enable (option 45.0) is set to '1', this option parameter allows the back-up data held in the display to be loaded into the PPC6000, this may take up to 5 minutes to complete during which time the control will not allow the burner to operate.

IMPORTANT: In order for the restore command to function, the new control must have the same communications address (Option Parameter 0.2) as the original control. That is, if option 0.2 was set to 2 (boiler #2 for example), the commissioning engineer must set options 0.2 of the new control to 2 **BEFORE** setting option 45.2 to 100. The default communications address of the control is 0. If multiple PPC6000's have been connected together for sequencing, it is likely that the communications address has been changed to match the boiler number.

To restore the data from the back-up held in the NX610 or the NXTSD104 display, set this option parameter to '100'.

If **100** is selected, **the data from the back-up data held in the display will be loaded into the PPC6000.**

A back-up of the data held in the PPC6000 is automatically stored in the display when the control is in modulation status.

NOTE: You must exit commissioning mode to initiate the restore.

5.6 Commission ratio mode

5.6.1 Description

Commission ratio mode is used for entering a new profile or changing an existing profile. Using commission ratio mode, it is possible to step through each setpoint including close, purge and ignition. Once a setpoint has been entered, it is not possible to go back and modify it again in the same commissioning session. To do this, adjust ratio mode must be used after all the required setpoints have been entered.

5.6.2 Using commission ratio mode



CAUTION

- Use extreme care while commissioning the system. While operating in commissioning mode the safety of the system is the sole responsibility of the commissioning engineer.
- Ensure a pre-purge position is entered for the relevant drives.
- Incorrect positioning of either fuel or air could cause a hazardous situation to occur.
- If the servo-motor positions have been up-loaded it is essential that the combustion is verified at each firing position to ensure a hazardous condition cannot occur, and for the data to be stored in the control.
- It is recommended that the close position for each servo motor is re-entered as part of the burner service regime, to compensate for wear in the servo-motor micro-switch during operation.
- Once all profile positions have been adjusted/entered it is essential that all profile points are checked to verify that the fuel air ratio is acceptable for the appliance being controlled.
- To adjust the position of a servo motor or inverter, select the motor using the scroll keys. then use the UP/DOWN keys to change the value.



Each setpoint in the profile is referred to with a letter and number (refer to the table below).

No.	Name	Comments
P0	Close	This defines the positions the motors will move to when the burner is off, and must be set to the lowest position each motor can reach.
P1	Purge	This defines the positions the motor will move to when the burner is purging, and can be set as required for each servo-motor.
P2	Ignition	Position during ignition. May be outside the normal firing range.
P3	Low fire	Low fire setpoint, (unless limited modulation range is selected).
.....	
Px	High fire	High fire setpoint, (unless limited modulation range is selected), which is the last setpoint entered (max. P24)

The procedure for entering or modifying a profile is as follows :

1. Enter commission ratio mode (see section 5.3.1). P0 (close) is displayed.
2. If the close setpoint has recently been entered and no change is required, press **NEXT**. If servicing the burner or the position has not been entered before, move each motor to its lowest position and press **ENTER**. P1 (purge) is displayed (flashing).
3. Select the burner and the required profile. If the purge position has been set before the selected motors will automatically move to their relevant P1 positions and stop, if no change is required press **NEXT**. Otherwise, move each motor to its required pre-purge position and press **ENTER**. If the purge setpoint has not been entered before the servo-motors will remain at their respective closed (P0) positions until each motor has been moved to its required position. Once all selected motors are at the correct position press **ENTER**. P1 (purge) is displayed. Please note that if a purge position for a particular drive has not been entered before the drive will remain at its closed position. **The engineer must ensure that the main combustion air damper is set to open enough to purge the boiler.**
4. Wait for the pre-purge time to elapse. If the ignition setpoint has been entered before, the drives will move to their ignition positions once all drives stop moving P2 (ignition) will be displayed, if a change is required or the ignition setpoint has not been entered before, move all the motors being used to their required ignition positions and press **ENTER**.
5. **To attempt ignition of the burner, hold down the NEXT key for approximately three seconds.** If it is wished to change the ignition position adjust the relevant drive(s) and press **ENTER**, if the position is acceptable press **NEXT**. **Once the relevant safety times have elapsed P3 will be displayed.**
6. If the low fire setpoint has been entered before and no change is required, press **NEXT**. Otherwise, move each drive to the required low fire position and press **ENTER**. P4 (next profile setpoint above low fire) is displayed.
7. Repeat step 6 for each required profile setpoint, up to a minimum of P4 and a maximum of P23.
8. Leave commission ratio mode. The last profile setpoint entered will become the high fire setpoint.
 - If a controlled shutdown occurs, the controller will return to step 2. The setpoints entered in the current commissioning session are not lost and the **NEXT** key may be used to step through the start-up sequence and fire the burner.
 - If a non-volatile lockout occurs, the setpoints are kept in the same way as for a controlled shutdown. It will be necessary to remove all faults before moving further than step 2.
 - If power is removed from the controller the setpoints entered in the current commissioning session will be lost.

5.6.3 Leaving commission ratio mode



To leave commission ratio mode and return to run mode, press the key labeled **RUN** followed by the key labeled **ENTER**.

- **If P3 (or higher) has been commissioned, the existing profile will be overwritten.** If you do not wish the existing profile to be overwritten, disconnect the power to the control without pressing **RUN** and **ENTER**.
- **Only the setpoints used in the current commissioning session will be stored.** For example, if an existing profile has setpoints up to P15 but only the setpoints up to P10 were viewed or altered, then only the setpoints up to P10 will be stored. Therefore, it is *vital* that **NEXT** is pressed to get to the last setpoint in the profile before leaving commission ratio mode. This does not apply if only the close, purge or ignition setpoints (P0, P1 or P2) are altered.

5.7 Adjust ratio mode

5.7.1 Description

Adjust ratio mode is used only for changing an existing profile.

- Using adjust ratio mode, it is possible to modify the motor positions for any setpoint in the firing range from low to high fire (P3 and higher).
- The setpoints may be chosen in any order.
- It is **not** possible to modify any motor position so that it is higher than the high fire setpoint.
- It is **not** possible to modify the close, purge or ignition positions (P0, P1 or P2 respectively). For this, commission ratio mode must be used.

5.7.2 Entering adjust ratio mode



To enter adjust ratio mode, turn the burner on. Once the burner begun its startup sequence, press the key labeled **COM** and obtain the adjust ratio passcode value using the **UP/DOWN** keys. Once the correct passcode value has been obtained, press the key labeled **ENTER**.

If the entered passcode was correct, 'A n' will be seen on the display, where n is the number of the setpoint currently under adjustment.

Entering the commission ration passcode while the burner is **ON** enters "Adjust Ratio" mode

5.7.3 Using adjust ratio mode



CAUTION

- Use extreme care while commissioning the system. While operating in adjust ratio mode the safety of the system is the sole responsibility of the commissioning engineer.
- Incorrect positioning of any drive could cause a hazardous situation to occur.

- To adjust the position of a servo-motor or inverter, select the relevant drive and use the **UP/DOWN** keys.
- To change the setpoint being modified, using the scroll key select the setpoint and then use the **UP/DOWN** keys.

Each setpoint in the profile is referred to with a letter and number.

No.	Name	Comments
A0	Close	The close setpoint cannot be altered in adjust ratio mode.
A1	Purge	The purge setpoint cannot be altered in adjust ratio mode.
A2	Ignition	The ignition setpoint cannot be altered in adjust ratio mode.
A3	Low fire	Low fire setpoint.
.....	
Ax	High fire	High fire setpoint, which was the last setpoint entered (max P24)

The procedure for modifying a setpoint is as follows:

1. Enter adjust ratio mode. 'A n' is displayed in the window, where n is the number of the setpoint that is closest to the current firing position.
2. Use the scroll key to select the setpoint and use the **UP/DOWN** keys to move to the setpoint in the firing range to be altered.
3. Wait for the 'A n' display to stop flashing and modify the drive(s) as required.
4. If the modified positions are not required, press the **NEXT** key to return the drive(s) to their original positions or use the scroll key to move to a different setpoint.
5. Press the **ENTER** key to store the new drive positions for the current setpoint.
6. Repeat steps 2-5 as required. Each time step 5 is completed, the new positions will be stored permanently.
7. Leave adjust ratio mode.

If the 'A n' display is flashing, it will not be possible to adjust the position of any of the drives. This may be for one of the following reasons:

- The burner is not firing. Switch the burner on and wait for the control to begin modulating.
- The current setpoint is A0, A1 or A2. Use commission ratio mode to adjust these setpoints.
- The drive(s) are moving to the required positions. Wait for the drive(s) to stop moving.



5.7.4 Leaving adjust ratio mode

Adjust ratio mode → **RUN** **ENTER** → Run mode

To leave adjust ratio mode and return to run mode, press the key labeled **RUN** followed by the key labeled **ENTER**.

5.8 Interrogating the software issue

There are two methods for finding the software issue:

1. From run mode, press the **COM** key. The Fireeye version number will appear.
2. Use the engineer's key (refer to section 6.6 for details.) and scroll up to EK200 for the current Fireeye operating version.



6 Faults and fault finding

6.1 The fault display

The PPC6000 series carry out a number of internal and external checks during operation. If a fault is found, a fault number (displayed with a text description) is used to identify the type of problem. A list of fault numbers may be found later in this chapter.

Many of the faults detected and displayed by the control will cause a non-volatile lockout of the burner, that is to say that removing the power to the control will not cancel a fault. Other faults will be displayed as a warning but operation of the burner will not be affected.

Each fault number is prefixed on the display by a letter as follows:

- F** This means that a fault has occurred and is still present. The fault may be internal or external to the control.
- C** This means that a fault did occur but has now cleared.
- L** This means a programmed limit has been exceeded.

For example:

217 PSI Actual AUTO F23:Drive 3 Fault
--

Many of the faults detected and displayed by the control will cause a non-volatile lockout of the burner. Other faults will be displayed as a warning but operation of the burner will not be affected. A complete list of faults may be found later in this chapter.

A fault history is available through the Engineers Key, the standard fault history is lost if the power is removed from the unit but as an option the fault history may be displayed with a date and time stamp, and retained in the unit memory in the event of a power loss to the control. For further information see section 6.6.1.

NOTE: LED on PPC6000: STATUS LED: Flashing LED indicates the control is OK. OFF = possible *open fuse 2* (F32 see Section 2.6.1) Also, OFF = possible *fatal processor fault*.

6.2 What to do when a fault occurs

If faults or limits are present and either the alarm or limit relay is closed, press the **MUTE/RESET** key to mute the alarm (open the relay).

Take note of the fault message and use the Fault Listing to identify why the fault occurred.

If the faults, which cause a non-volatile lockout, are still present when the alarm is muted, the alarm will operate again when the alarm clears, to indicate to the operator that the control may be restarted.

Once all faults have been diagnosed, rectified and cleared, press the **MUTE/RESET** key for approximately three seconds to remove the fault messages and re-start the burner.



The function of the **MUTE/RESET** key may also be achieved via ComFire or using the MUTE/RESET input. See option parameter 1.2.

6.3 Non-volatile lockout

If power is removed from the control while a fault is still present, the fault will be stored in non-volatile memory. When power is restored to the control, the fault number will still be present and it will be necessary to remove the fault before restarting the burner.

6.4 Fault subsets

As an aid to fault finding, most faults also have a *fault subset* that gives additional information about the type of fault or what the burner was doing when the fault occurred. Where applicable, the subsets are given in the fault listing in section 6.5

6.5 Fault listing

Fault Number	Cause	Description
F01	External Alarm Fault 1	One of the low voltage alarm / lockout inputs is causing an alarm.
F02	External Alarm Fault 2	The fault may be prefixed by either an 'L' or an 'F' and may or may not shutdown / lockout the burner.
F03	External Alarm Fault 3	See Option parameters 19.1 to 19.4.
F04	External Alarm Fault 4	<i>Subset: burner status.</i>
F18	Not enough setpoints entered	A fuel/air ratio profile has been selected which does not have at least four setpoints commissioned. <ul style="list-style-type: none">• Use commission ratio mode to enter more setpoints. <i>Subset: fuel code</i>
F19	Circuit board voltage reference fault	The circuit board has an incorrect on-board reference level. <ul style="list-style-type: none">• Ensure ALL analog inputs (4-20mA, 0 – 5v) are in the range 0 to 5.0 volts. It is critical that none of the inputs are higher than 5.0 volts.• If the problem persists even when all analog inputs are disconnected, check EK37 and contact supplier. <i>Subset: +1 out of range, +2 zero check failed, +4 span check failed.</i> See EK37 for more details.



Fault Number	Cause	Description														
F20	Drive 0 position fault	A drive-positioning fault has occurred, which will cause a non-volatile lockout of the burner. This fault has occurred for one of the following reasons:														
F21	Drive 1 position fault	1. During close position prove, when a drive stops at a position that is outside the close set position by more than five degrees.														
F22	Drive 2 position fault	2. During purge position prove, when a drive stops at a position that is outside the purge set position by more than five degrees.														
F23	Drive 3 position fault	3. During pre-purge, ignition or post-purge, when a drive moves from its setpoint.														
F24	Drive 4 position fault	4. During modulation, when a drive is not at its correct setpoint as defined by the commissioned fuel/air ratio for the selected profile.														
F25	Drive 5 position fault	A drive is defined as having moved from its setpoint if its positional error is more than 1° for 15s, or more than 5° for 1s. For positional errors between 1° and 5°, the detection time is variable between 15s and 1s.														
F26	Drive 6 position fault	Note: Only the selected drives are checked, i.e. used on the current fuel/ air profile. The other drives are ignored. <i>Subset: burner status.</i>														
F27	Drive 7 position fault	<i>000 - 016 = Position fault at the status number</i> <i>032 - 048 = CAN communications error. Display shows ERR1 under drive name.</i> <i>> 064 = Internal servo fault., Display shows ERR2 - ERR7 under the drive name.</i>														
F28	Drive 8 position fault	Note: A message ERR1, ERR2, ERR3 on the display indicates a communications failure with a given servo-motor. This could be caused by a wiring error or an incorrectly selected serial number. Verify selections in Option parameter 03.x.														
F29	Drive 9 position fault															
F32	Safety input fault	One or more of the fail-safe low voltage inputs is registering a fault. <i>Subset: Combination of failed inputs.</i> <table border="1" data-bbox="743 1669 1295 1923"> <thead> <tr> <th>Subset #</th> <th>Input I</th> </tr> </thead> <tbody> <tr> <td>0</td> <td>N/A</td> </tr> <tr> <td>1</td> <td>1</td> </tr> <tr> <td>2</td> <td>2</td> </tr> <tr> <td>4</td> <td>3</td> </tr> <tr> <td>8</td> <td>4</td> </tr> <tr> <td>128</td> <td>Air pressure input</td> </tr> </tbody> </table>	Subset #	Input I	0	N/A	1	1	2	2	4	3	8	4	128	Air pressure input
Subset #	Input I															
0	N/A															
1	1															
2	2															
4	3															
8	4															
128	Air pressure input															



Fault Number	Cause	Description
F33	Burner input fault	<p>One or more of the high voltage (profile select) inputs is registering a fault.</p> <p><i>Subset: Failure mode.</i></p>
F34	Primary relay fault	<p>One or more of the internal relays is not responding correctly.</p> <p><i>Subset : 1 - 10 = Failed relay number</i></p>
F35	ADC fault	<p>One of the internal checks on the analog to digital converter has failed.</p> <p><i>Subset: Failure mode.</i></p>
F36	Reset fault	<p>This fault occurs if the control receives more than 5 'false' restart requests within a 15 minute period.</p> <p>A false restart request occurs then the fault mute key / input is held for more then three seconds when there is no fault present. This is to protect against a failure in an external device continually re-starting the control, which could cause un-attended burner restarts in the event of a genuine burner problem. This is important since the fault mute function can come from anywhere via a digital input or serial communications.</p> <p>To clear the fault, either enter a commission mode, or cycle the power to the control.</p> <p>The subset in not applicable for this fault</p>
F37	RAM test fault	<p>The main memory in the control has malfunctioned.</p> <ul style="list-style-type: none">• Interrupt power to the control.• This could be due to high levels of electrical interference getting into the product. Check all cables are correctly screened, and screens are terminated correctly. Ensure the mains supply is not excessively noisy.• If this fault persists, the control must be returned to the supplier. <p><i>Subset: Failed Page.</i></p>



Fault Number	Cause	Description
F38	Program memory CRC fault	<p>The program memory in the control has been corrupted.</p> <ul style="list-style-type: none"> • Interrupt power to the control. • This could be due to high levels of electrical interference getting into the product. Check all cables are correctly screened, and screens are terminated correctly. Ensure the mains supply is not excessively noisy. • If this fault persists, the control must be returned to the supplier. <p><i>Subset: Failed Page.</i></p>
F39	Profile table CRC fault	<p>The profile table memory in the control has been corrupted.</p> <ul style="list-style-type: none"> • Interrupt power to the control. • Erase the system using option parameter 45.1 = 5 and re commission (or restore with option parameter 45.2). • This could be due to high levels of electrical interference getting into the product. Check all cables are correctly screened, and screens are terminated correctly. Ensure the mains supply is not excessively noisy. • If this fault persists, the control must be returned to the supplier. <p><i>Subset: Failed Page.</i></p>
F40	Spare	N/A
F41	Boiler safety limit exceeded	<p>The boiler's measured value has exceeded the pressure/temperature safety limit.</p> <p><i>Subset: 4 - safety limit exceeded</i></p>
F42	<i>Reserved</i>	
F43	<i>Reserved</i>	
F44	Burner not OFF.	<p>This fault will lock the burner out if the AUTO input (PA10 – PA11) is made when the control thinks the burner should not be firing. It will also occur if the AUTO input stays ON for three seconds after this control has opened the 'controlled shutdown relay' – i.e. tried to turn the burner off.</p> <p><i>Subset: burner status.</i></p>
F45	<i>Reserved</i>	



Fault Number	Cause	Description
F46	EEPROM memory CRC fault	<p>The EEPROM memory in the control has been corrupted. This memory is used to store the option parameters,</p> <ul style="list-style-type: none"> • Interrupt power to the control. • Erase the system using option parameter 45.1 = 5 and re commission (or restore with option parameter 45.2). • This could be due to high levels of electrical interference getting into the product. Check all cables are correctly screened, and screens are terminated correctly. Ensure the mains supply is not excessively noisy. • If this fault persists, the control must be returned to the supplier. <p><i>Subset: Failed Page.</i></p>
F50	Oxygen probe heater fault	<p>The probe heater has failed to heat to the correct temperature after 30 minutes of system power up.</p> <ul style="list-style-type: none"> • Is the probe heater wiring correct? • Is the probe cell thermocouple wiring correct? <p>Once the fault is rectified, it will be necessary to interrupt the power to the oxygen probe interface to make it attempt to heat the probe once more.</p> <p><i>Subset: O2 probe status.</i></p>
L52	Oxygen low limit alarm	<p>The oxygen level measured value is below the oxygen setpoint low alarm value for the current profile.</p> <p><i>Subset: 0 = Limit violation, 1 = Probe Failed.</i></p>
L53	Oxygen high limit alarm	<p>The oxygen level measured value has exceeded the oxygen setpoint high alarm value for the current profile.</p> <p><i>Subset: 0 = Limit violation, 1 = Probe Failed.</i></p>
F54	Oxygen probes mismatch fault	<p>This fault occurs when two oxygen probes are used to give fail-safe oxygen monitoring. If this fault occurs, check and calibrate both oxygen probes. It may be necessary to increase option parameter 42.4 or 42.5 (within safe limits) if the oxygen probes are in different parts of the flue.</p> <p>Subset: 1 = Oxygen values don't match, 2 = Flue temperatures don't match 3 = Neither flue temperature or oxygen levels match 255 = Second oxygen probe is faulty / not ready. See EK 76.</p>



Fault Number	Cause	Description
L55	Trim limit alarm	<p>The trim drive has reached the allowed maximum deviation limit.</p> <ul style="list-style-type: none"> • Change trim limit. • Re-commission fuel / air ratio. <p><i>Subset: Not applicable.</i></p>
F57	Auto trim commissioning fault	<p>The measured oxygen level exceeded 15.0% during auto trim commissioning. The burner is shutdown.</p> <p><i>Subset: Last auto trim commission setpoint (+32 if adding air).</i></p>
L58	Flue temperature low alarm value exceeded	<p>The measured flue temperature is below the low alarm value for the current profile, or the flue thermocouple is faulty.</p> <p><i>Subset: Not applicable.</i></p>
L59	Flue temperature high alarm value exceeded	<p>The measured flue temperature has exceeded the high alarm value for the current profile.</p> <p><i>Subset: Not applicable.</i></p>
F60	Spare	Currently unassigned
F61	Combustion air pressure fault	<p>Applicable if combustion air pressure monitoring is used (using a 4-20mA pressure sensor). This fault will lock out the burner if the measured combustion air pressure does not match that expected for the current firing rate for six (6) seconds.</p> <p><i>Subset is not used (will be zero).</i></p>
F62	Spare	Currently unassigned
F63	Option parameters uploaded	<p>The option parameters have been uploaded via serial communications. Check all values are correct and match the application, then set option parameter 45.0 to 0.</p> <p><i>Subset : Not applicable.</i></p>



Fault Number	Cause	Description
F64	Profile Invalid	<p>This fault means that the control can't fire the currently selected profile because it isn't sure it still matches the burner / site configuration. It could lead to a hazardous situation.</p> <p>There are three possible causes to this fault:</p> <p>1 – A drive has been commissioned in this profile but has now been deselected. If a profile is commissioned with two air dampers but then the second air damper is de-selected with option parameter 4.0 to 4.9, the profile is no longer valid.</p> <p><i>Subset: Drive number (0 to 9)</i></p> <p>2 – Servo / Drive changed. If the system is commissioned then later one of the servos is changed for a new one (i.e. different serial number), any profiles that use that servo are now considered invalid. This is to force the engineer to ensure the new servo is mechanically connected the same way as the original one.</p> <p><i>Subset: Invalid profile + 100 (101 to 104).</i></p> <p>3 – The selected profile has been uploaded from a PC, but has not been verified on this burner.</p> <p><i>Subset: Invalid profile + 100 (101 to 104).</i></p> <p>In all cases the F74 can be cleared by switching to another (good) profile, or by re-commissioning the profile in 'commission ratio' mode, making sure all points up to and including high fire are acknowledged using the 'NEXT' key (or 'ENTER' if the points are adjusted).</p>
F65	Power-up Lockout	<p>The control has locked out on power-up. This will normally be because option parameter 1.0 is set to 1.</p> <p><i>Subset:</i></p> <p>1 – See option parameter 1.0. 254 – Serial EEPROM write failure. 255 – NV Lockout verification failed.</p>
F66	Spare	Currently unassigned
F67	Secondary relay fault	<p>A secondary fault has occurred with the non-volatile lockout relay. A Self check is performed once an hour and two consecutive failures will cause the fault to appear and the burner to lock-out immediately.</p> <ul style="list-style-type: none"> • Contact supplier <p><i>Subset: Failed relay number.</i></p>



Fault Number	Cause	Description
F68	Secondary program memory checksum fault	A fault has occurred with the program memory in the control. A Self check is performed once an hour and two consecutive failures will cause the fault to appear and the burner to lock-out immediately. <ul style="list-style-type: none">Contact supplier <i>Subset: Not applicable.</i>
F69	Secondary watchdog fault	A fault has occurred with the CPU watchdog. A Self check is performed once an hour and two consecutive failures will cause the fault to appear and the burner to lock-out immediately. <ul style="list-style-type: none">Contact supplier <i>Subset:</i> <i>1 = Late test failed.</i> <i>2 = Early test failed.</i>
F70 – F79	User Faults	These fault numbers are generated by the user programmable section of the control and will vary with the application.

6.6 The engineer's key

By selecting the engineer's key it is possible to read the values of internal system variables and external input and output states. It is also possible to see the values of *fault subsets*, in order to obtain more detailed information about a fault that has occurred.

When using the engineer's key it is not possible to change any parameters. Therefore, it is not possible to affect the operation of the burner.

After pressing the Engineer's Key:

- The top line of the display will show an EK (data register) number and the value of the register.
- The bottom line of the display will show the EK description.

For example:

EK025= 2 Burner Status

- If there is a fault present, this will be shown on the right hand side of the top line in the format Fnn,sss where nn = fault number, and sss = fault subset value. Note, this fault information will only be shown when viewing EK numbers 1 to 100.
- Use the UP/DOWN keys to change the EK number and view its corresponding data.
- Press the EK to index back to the normal display. The control will revert automatically to the normal run display if a key has not been pressed for one minute.

6.6.1 Fault history

The PPC6000 series stores information on faults. The memory in the unit will store the last 128 faults and associated status data and as an option a date and time stamp. The 100 most recent faults are available via the display unit and all 128 are available through ComFire. The Engineers Key gives access to the fault history.

To view the fault history scroll up through the EK's numbers until EK200 then by scrolling once more the most recently occurring fault is displayed, indicated by 00 in the top left corner of the display.

For example:

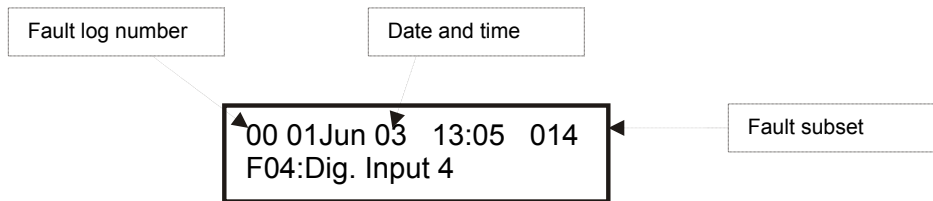

Earlier faults are displayed by indexing using the UP key. The fault log can be navigated using the UP/DOWN keys

6.6.2 Engineer's key parameter list

No.	Name	Description
EK1	Low Voltage Digital Input 1 (PA5–PA11)	Shows the state of each input. Where: 0 = OFF (Open circuit) 1 = ON
EK2	Low Voltage Digital Input 2 (PA6–PA11)	
EK3	Low Voltage Digital Input 3 (PA7–PA11)	
EK4	Low Voltage Digital Input 4 (PA8–PA11)	
EK5	Low Voltage 'HIGH' input (PA9–PA11)	
EK6	Low Voltage 'AUTO' input (P10–PA11)	
EK8	Profile 1 Select – Line Voltage (PE9)	
EK9	Profile 3 Select – Line Voltage (PE11)	
EK10	Profile 2 Select – Line Voltage (PE10)	
EK11	Profile 4 Select – Line Voltage (PE12)	



No.	Name	Description
EK16	Low fire hold or warming limit active	<p>0 - Measured value above warming limit, burner free to modulate.</p> <p>1 - Measured value below warming limit, burner held at low fire if the control is in auto or sequencing mode.</p>
EK18	Boiler status	<p>0 - Burner will not fire because the temperature / pressure measured value has exceeded the high control value.</p> <p>1 - Burner will fire because the temperature / pressure measured value has fallen below the low control value.</p>
EK19	Confirm to adjust	<p>0 - Control not in commission mode or control is in commission mode and drives moving to setpoints.</p> <p>1 - Control in commission mode and drives may be adjusted using the UP/DOWN keys.</p>
EK20	Drive moved	<p>0 - Control not in commission mode or control is in commission mode and drives have not been moved using the UP/DOWN keys.</p> <p>1 - Control in commission mode and drives have been moved using the UP/DOWN keys.</p>
EK21	Positions proved	<p>0 - Drives have stopped moving, ready for position prove test.</p> <p>1 - Ready for position prove test but drives still moving.</p>
EK22	Fault alarm	<p>0 - No alarms (faults) present.</p> <p>1 - Any Un-muted fault alarm present</p>
EK23	Oxygen Trim Enable	<p>0 - Oxygen trim off or not working.</p> <p>1 - Oxygen trim on and working.</p> <p>Note: EK23 = 1 IF EK46 = 0</p>
EK25	CAN_TX Failures	<p>A count of the number of times the CANbus controller has failed to send a message since power-up. This should be zero unless there has been a problem.</p>
EK26	Commission status	<p>Current commissioning mode, where:</p> <p>0 - Normal run mode.</p> <p>1 - Adjust ratio mode.</p> <p>2 - Commission ratio mode.</p>



No.	Name	Description
EK27	Commission setpoint	The current setpoint being commissioned. 0 - Closed setpoint. 1 - Purge setpoint. 2 - Ignition setpoint. 3 - Low fire setpoint. 4 - 24 - profile setpoints
EK28	Commission Setpoints entered	The number of setpoints that have been successfully entered during this commission ratio session.
EK29	Modulation rate (%)	The current modulation rate of the burner. 0 = Low Fire 100 = High fire
EK30	Burner Status	Status of the start-up sequence. See section 4.2
EK31	Fuel Profile Selected	The currently selected fuel profile.
EK32	Number of commission setpoints	The number of setpoints entered for the current selected profile: 0 - No setpoints entered. 1 - Close setpoint only. 2 - Close and purge setpoints. 3 - Close, purge and ignition. 4 - 24 - profile setpoints.
EK33	Modulation mode	0 - Auto mode. +1 - Manual from keyboard / TSD +2 - Low fire hold from keyboard / TSD +4 - Local 1. +8 - Local 2. +12 - OFF from Display Ex.: 10 would be local 2, LFH. 4 would be local1, auto mode.
EK36	Nearest setpoint	The number of the profile setpoint which is nearest to the current modulation position.
EK37	Voltage reference error (V)	The error between the measured voltage reference and the calibrated value has been exceeded for 3 seconds. Typically this value will be < 0.05v and F19 will occur if it is > 0.12v. If the value is high, ensure none of the low voltage inputs are above 5 volts
EK38	RS485 Communications status	Toggles between 1 and 0 when RS485 is active on the local interface (not the Modbus interface).



No.	Name	Description
EK39	Fuel Swap Status	If non zero, the control is in the process of performing a fuel profile swap (without turning the burner off).
EK40	Shutdown setpoint	The nearest setpoint (EK36) when the burner last locked out.
EK42	Adjust ratio counter	The number of times adjust ratio mode has been used.
EK43	Commission ratio counter	The number of times commission ratio mode has been used.
EK44	Oxygen measured value	The current flue oxygen value as measured by the ETC Oxygen probe (if fitted).
EK45	Oxygen probe status	0 – Probe OK +1 - Internal fault. +2 - Internal fault. +4 - Heater fault. Causes F50. +8 - Cell temperature out of range. +16 - Cell millivolts out of range. +32 - CANbus error. +64 - Probe calibrating in reference gas. See option parameter 30.6. +128 - Probe calibrating in air. See option parameter 30.6.
EK46	Oxygen trim status	0 - O2 trim working, or +1 – no oxygen interface connected. +2 – no oxygen probe serial number entered, or option 30.5 not 1, or option 30.8 not 0 or trim not selected via aux input or trim not selected via serial comms +4 – O2 setpoints or flow values incorrect +8 - Option 20.6 not 0 +16- Not modulating +32- In commission mode +64- Probe faulty (see EK45)
EK47	Oxygen setpoint (%)	Current oxygen setpoint. This is only available if trim is enabled and working.
EK48	Excess air (%)	Excess combustion air at the current firing position.
EK49	Oxygen error (%)	Error between O2 measured value and O2 setpoint.



No.	Name	Description
EK50	Trim deviation (% flow)	Deviation in air flow imposed by trim (-25 to +25%)
EK55	Main PCB issue	The issue number of the main circuit board that the firmware is expecting. This may be different to the actual PCB issue if they are compatible.
EK56	Software issue.	The current revision of the main product firmware.
EK58	CPU serial number (low 4 digits)	The CPU board serial number.
EK59	Drives at setpoint	Represents which drives are currently at their setpoints, where: 0 – All drives are at their setpoints and are not moving. Non- zero – One or more drives are not at their setpoint.
EK60	Digital (relay) outputs on.	The combination of digital outputs currently switched on. +1: Digital Output 1 ON. Display, PR3 (COM), PR1 (NO), PR2 (NC). Low voltage or line voltage. +2: Digital Output 2 ON. Display, PR7 (COM), PR5 (NO), PR6 (NC). Low voltage or line voltage. +4: Digital Output 3 ON. Display, PR7 (COM), PR9 (NO), PR8 (NC). Low voltage or line voltage. +8: Digital Output 4 ON. PPC6000, PE4 (line voltage out). +16: Digital Output 5 ON. Not implemented. +32: Digital Output 6 ON. Not implemented. +64: Digital Output 7 ON. Daughterboard, PZ15 – PZ16. LOW VOLTAGE AND CURRENT ONLY. +128: Digital Output 8 ON. Daughterboard, PZ17 – PZ17. Not implemented.
EK61	Analogue/Digital Input 1. PPC6000 Terminal PA5.	The raw ADC counts from analogue/digital input 1. 0 to 1023 for 0 to 5.00 volts. 4mA = 180 counts 20mA = 900 counts

No.	Name	Description
EK62	Analogue/Digital Input 2. PPC6000 Terminal PA6.	The raw ADC counts from analogue/digital input 2. 0 to 1023 for 0 to 5.00 volts. 4mA = 180 counts 20mA = 900 counts
EK63	Analogue/Digital Input 3. PPC6000 Terminal PA7.	The raw ADC counts from analogue/digital input 3. 0 to 1023 for 0 to 5.00 volts. 4mA = 180 counts 20mA = 900 counts
EK64	Analogue/Digital Input 4. PPC6000 Terminal PA8	The raw ADC counts from analogue/digital input 4. 0 to 1023 for 0 to 5.00 volts. 4mA = 180 counts 20mA = 900 counts
EK65	Analogue Input 5. PPC6000 Terminal PA12 (also remote setpoint).	The raw ADC counts from analogue input 5. 0 to 1023 for 0 to 5.00 volts. 4mA = 180 counts 20mA = 900 counts
EK66	Analogue Input 6. PPC6000 Terminal PB9 (also boiler measured value).	The raw ADC counts from analogue input 6. 0 to 1023 for 0 to 5.00 volts. 4mA = 180 counts 20mA = 900 counts
EK67	Analogue input 7. Daughterboard terminal PZ12 (-) PZ13 (+). Also VSD1.	The ADC counts from analogue input 7. 0 to 999 for 4 to 20mA.
EK68	Analogue input 8. Daughterboard terminal PZ13 (-) PZ14 (+). Also VSD2.	The ADC counts from analogue input 8. 0 to 999 for 4 to 20mA.
<p>Note for EK67 and EK 68: Terminal PZ13 alternates \pm to detect any direct connection between these two inputs.</p>		
EK69	Daughter board Frequency input 1 (PZ7). 0 to 12 volts.	Gives the measured frequency in Hz on this input. If the input is not changing, this value will be 0 for OFF (open circuit) and 1 for ON.
EK70	Daughter board Frequency input 2 (PZ9). 0 to 12 volts.	Gives the measured frequency in Hz on this input. If the input is not changing, this value will be 0 for OFF (open circuit) and 1 for ON.



No.	Name	Description
EK71	Daughter board Frequency input 3 (PZ11). 0 to 12 volts.	Gives the measured frequency in Hz on this input. If the input is not changing, this value will be 0 for OFF (open circuit) and 1 for ON.
EK72	Oxygen probe cell temperature.	The temperature of the zirconia cell inside the ETC oxygen probe, if fitted. This value should be very close to 650°C for accurate operation.
EK73	Ambient temperature.	The temperature measured by the inlet temperature sensor, if fitted. Units are °C.
EK74	CPU utilisation (%).	The percentage utilisation of the CPU. Should be less than 95% at all times.
EK75	Second O2 level (%)	The measured flue oxygen level as measured by the second oxygen probe interface. (%)
EK76	Second probe status	The same as EK45, but for the second oxygen probe.
EK77	Program size.	This is the length of the currently running user / manufacturers program. If a user program is selected, this should match the program length given by the 'abacus' software.
EK78	Second cell temp (°C)	The internal zirconia cell temperature of the second oxygen probe, if fitted.
EK79	Second flue temp (°C)	The flue temperature, as measured by the second oxygen probe, if fitted.
EK80 - 89	Drive Error values for drives 0 to 9.	The current error value for drives 0 to 9. These values will freeze when the control performs a safety shutdown, so it may be possible to look at these values after a lockout to help determine the cause.
EK90	Burner cycles	The number of times the burner has attempted to start.
EK91	Burner Lockouts	The number of times the burner has locked out.
EK92	Commission data backup verification progress	Description This counts up as the backup is verified when the burner is running. If a difference between the actual commissioning data and the backup is found, it will go to zero. A value of 999 indicates that the entire backup has been verified so all commissioning data are backed up in the display.

No.	Name	Description
EK93	Flow value	The instantaneous calculated air or fuel flow value, as used by the oxygen trim function. If flow values have been entered during commissioning for the current profile, this value will show the flow rate that corresponds to the current modulation rate. At high fire, the value will be 99.9%. At low fire, it will be this divided by the turn down of the boiler. If fuel trim is active, this will track air flow. If air trim is active, this will track fuel flow.
EK94	Reserved	N/A
EK95- EK97	Spare	N/A
EK98	Combustion air pressure / error (added with firmware version 1.219) (EK56)	If a combustion air pressure sensor is used (in addition to the main air pressure switch), in commission modes, this will give the measured combustion air pressure. In run mode, this will give the combustion air pressure error which is the difference between the measured and expected air pressure.
EK99	Spare	N/A
EK100	Firmware type PT22...	This shows the last four digits of the firmware part number for the PPC6000 software. It is used for product variant identification.



- The product allows for customization of various non-safety critical functions including the modulation control. The engineers' keys shown below relate to the default modulation control function programmed in the control at the factory. To verify this has not been replaced by an application specific function check with the equipment supplier and / or check option parameter 00.4, if available.

NOTE: EK101-200 (shown in next table) are controlled by the loaded modulation program. The values given below are for the latest (version 40 (EK200)) production version but user programs may change / add to these.

No.	Name	Description
EK101	PID1 Active	If the value is 1, Setpoint / PID set 1 is active.
EK102	PID2 Active	If the value is 1, Setpoint / PID set 2 is active.



No.	Name	Description
EK103	Control Limits Active	If the value is 1, the control limits are active and will turn the burner on and off as the load dictates. The low and high limits are shown on EK153 and 154. If the control limits are holding the burner off, EK18 will be zero.
EK104	User modulation mode	This will normally be zero. A custom modulation program may change this value if it is modifying the modulation rate.
EK105	PID not required	If this value is 1, the internal modulation PID is not running. This may be because the burner is off, in commission / manual mode or for another reason.
EK106	Burner Firing	If this value is 1, the burner is firing (fuel valves open), or it is in post-purge.
EK107	Warming Limit Active	If this value is 1, the warming limit function (see option parameter 23.0) is holding the burner at low fire (status 15).
EK108	Tracking Active	If this value is 1, the remote tracking function is active. See option parameter 20.7. The AUTO modulation rate will come from analog input 5.
EK109	Remote Setpoint 1 Active	If this value is 1, the remote setpoint 1 function is active. See option parameter 20.7. The value of Setpoint 1 will come from analog input 5.
EK110	Control limit exceeded.	
EK111 to EK114.	Not used by the standard manufacturers program. May be used by a custom program.	N/A
EK115	Comms modulation active.	
EK116 to EK132.	Not used by the standard manufacturers program. May be used by a custom program.	N/A
EK133	SP2 selected remotely	If this value = 1, the second PID modulation setpoint (SP2) has been selected remotely via serial communications (including sequencing and Modbus).
EK134	Boiler sequencing communications good	If this value = 1, the control is receiving setpoint selection requests via serial communications (including Modbus and boiler sequencing). This usually indicates that boiler sequencing is working."
EK135	AUX input in use	This value = 1 if option parameter 20.7 (analog input 5 function) is non-zero.



No.	Name	Description
EK136	Lag on temperature active	This value = 1 if the control is currently banking based on a temperature setpoint for SP2
EK137	Remote lead selected	This value = 1 if the another boiler has been selected to be lead boiler instead of this one.
EK138	SP1 selected remotely	If this value = 1, the first PID modulation setpoint (SP1) has been selected remotely via serial communications (including sequencing and Modbus).
EK139	preload lag status	Used internally to keep the same boilers firing when the lead boiler changes.
EK140 to EK 150	Not used by the standard manufacturers program. May be used by a custom program	N/A
EK151	Setpoint 1 control value	The actual value of setpoint 1 being applied.
EK152	Setpoint 2 control value	The actual value of setpoint 2 being applied.
EK153	Low control limit	The actual value of the low control limit (cut-in point) being applied.
EK154	High control limit	The actual value of the High control limit (cut-out point) being applied.
EK155	Spare	N/A
EK156	Measured Value	The current boiler measured value (actual value) shown with increased precision.
EK157	AUTO modulation rate	The modulation rate that the boiler will fire to if in AUTO mode (providing option parameter 15.0 is not zero or 1).
EK158	Not used by the standard manufacturers program. May be used by a custom program.	N/A
EK159	Banking water temperature	Actual water temperature measured in °C or °F
EK160 to EK199.	Not used by the standard manufacturers program. May be used by a custom program.	N/A
EK200	Prog:	Currently running manufacturers / custom (user) modulation program name and revision number (if applicable).

*** EK101-200 are controlled by the loaded modulation program. The values given below are for the latest (version 40) production version but user programs may change / add to these.**



6.7 Troubleshooting

6.7.1 Display / General

Problem	Possible cause	Suggested action
Display shows it's serial number but not data from control unit	Display CAN bus wired incorrectly. PPC6000 not running.	Check wiring of CAN bus (PT3 and PT4). Check PPC6000 low voltage electronics fuse FS2. If blown, investigate all low voltage external wiring and replace fuse, if necessary, with a new one of the correct type and rating.
Display will not light at all.	24VAC supply to display missing. PPC6000 not running.	Check for 24VAC on PT1 and PT2. Check fuse FS1. If blown, investigate all high and low voltage external wiring and replace fuse, if necessary, with a new one of the correct type and rating.
Measured value incorrect.	Wrong sensor voltage. Wrong sensor input type. Incorrect sensor wiring. Wrong zero or span.	Check SENS SUPP link (see 2.5.3). Check SENS IN link (see 2.5.3). Check wiring to terminals PB8 - 10. Check option parameters 15.0, 15.1, 15.2.
Hours run shows '---'.	No profile selected.	Select a profile.
Modulation rate is 1%	Burner not modulating.	Wait for burner to finish start-up sequence. Check PID proportional band – must be greater than zero to modulate.
Burner status is flashing.	Control in non-volatile lockout mode.	Burner status before shutdown displayed.
SEE ALSO – Operation in Local Mode		

Operation in Local Mode

NOTE: This function is not available on displays manufactured after September 2007

Since a common PPC6000 display can be connected up to as many as sixteen PPC6000's at once, a common display must have the desired PPC6000's address set in order to communicate. This is done by entering "local mode" at the display and scrolling up or down to the desired address and exiting local mode. If communications to a display is lost for approximately two seconds, the display enters local mode. If communications is reestablished the display will revert to normal operation.

To enter local mode, press both the left and right arrow keys simultaneously. The display will show the following;

TOP LINE- The address (unit) number it is connected to. **N/C indicates** the PPC addressed is **not present**. Set to match PPC6000 (default is zero).

BOTTOM LINE- Alternates between serial number and software version and the fault logging and commissioning backup status. "FL" and "CDBKP" indicates a fault log and backup of the selected address exists.

To exit local mode, press either the "Data" or "COM" key.



A display can only log the faults of up to eight PPC's, therefore the fault log range is selected by holding down the right arrow key and the Engineers Key (Fireeye logo) simultaneously. The ranges are as follows;

<u>Fault Mode on CANbus</u>	<u>Fault Log Range</u>
0	No Logging
1	Address 0-7
2	Address 8-15

6.7.2 Startup

Problem	Possible cause	Suggested action
Burner will not start.	Control in non-volatile lockout. High control limit exceeded. Control in commission ratio mode. Burner off via serial comms. Waiting for burner controller.	Hold MUTE/RESET key when faults clear. Check EK18 and wait for press/temp to drop. Press NEXT to advance to next setpoint. Turn the burner ON using ComFire software (if fitted). Use section 4.2 and burner status (EK30) to see what the control is waiting for.
Drive positioning fault occurs before drives move to purge.	Stored close positions do not match actual close positions.	Check feedback potentiometers and motor micro-switches. Reset close positions using commission ratio mode.
Drive positioning fault occurs when drives reach purge.	Stored purge positions cannot be reached.	Check feedback potentiometers and motor micro-switches. Reset purge positions using commission ratio mode.
Drives stuck at ignition and burner has not fired.	Drives cannot reach ignition position.	Check motor micro-switches and linkages.

6.7.3 Commissioning

Problem	Possible cause	Suggested action
Cannot get past P0.	See 'burner will not start' above.	See 'burner will not start' above.
'Px' or 'Ax' display flashes constantly and motor positions cannot be altered.	Drives moving to position. Burner off in adjust ratio mode. A0, A1, A2 displayed. Waiting for burner controller.	Wait for drives to position. Turn burner on if you need to adjust points a3 onwards. Use section 4.2 and burner status (EK30) to see what the control is waiting for.
Option parameter not available.	Another option parameter must be set first.	Set option parameter (usually XX.0) to a non-zero value to enable other params. in group.
Option parameter not adjustable.	Wrong passcode entered or burner firing.	Enter the supplier passcode and/or turn the burner off before changing the value.
Not possible to enter commission ratio mode.	Supplier passcode incorrect. Burner firing (goes into adjust ratio mode).	Enter correct passcode. Turn burner off and try again.
Not possible to enter adjust ratio mode.	Supplier passcode incorrect.	Enter supplier passcode with the burner on.



6.7.4 Modulation

Problem	Possible cause	Suggested action
Sensor or modulation rate inaccurate.	V/I input setting incorrect. 5/24V supply setting incorrect.	Check option parameter. Check SENSOR IN and SUPPLY links.
Intermittent positioning faults.	Profile too close to micro-switch. Poor Ground (earth) or screening. Feedback potentiometer faulty. Communication to servo-motor(s).	Move end points further away from high/low. Check wiring. Move motor across range and check the feedback in commission ratio mode with the burner off. Check wiring.
Control stuck at low fire.	Meas. value exceeds setpoint. Warming limit active Control in manual. External low fire hold, or missing AUTO input from burner controller. In manual mode.	No fault. Wait for boiler to warm up. Check EK16. Press the AUTO key to change to auto mode Remove feed from Aux inputs (if selected). Check EK 6. Increase the mod. rate using 'UP' key. Check PID, proportional band must be greater than zero to modulate.
Control stuck at a modulation rate.	Serial communications. Control in commission mode.	Disable or change modulation slider in Computer software. Press RUN then ENTER to enter run mode.

6.7.5 Inverters



CAUTION

Due to the possibility of High Frequency electrical noise, **BOTH** ends of the shielded signal wire to the VSD **must** be grounded.

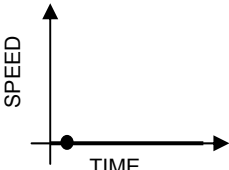
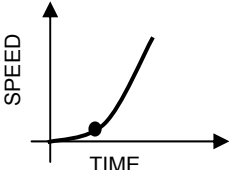
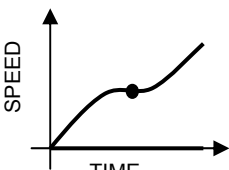
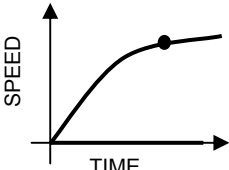
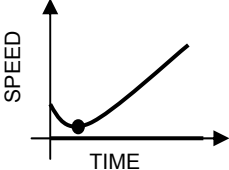
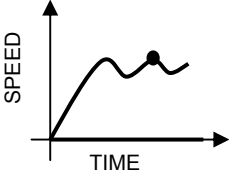
Problem	Possible Cause	Solution
	<ul style="list-style-type: none"> Inverter does not start because it does not receive a RUN signal. 	<ul style="list-style-type: none"> Ensure that the inverter receives a RUN signal from the burner fan motor output on the PPC6000 series control.
	<ul style="list-style-type: none"> Inverter has a slow start. Late RUN signal. Non-linear output from inverter or inverter's PID is enabled 	<ul style="list-style-type: none"> Ensure that the inverter's slow start feature is disabled. Ensure that the inverter receives a RUN signal from the burner controller at the same time as the PPC6000. Check that the inverter's output is selected to be linear, and that the inverter's own PID loop is disabled.
	<ul style="list-style-type: none"> Current limit reached Noise 	<ul style="list-style-type: none"> Slow down the inverter by increasing its acceleration / deceleration time settings. Check cable screens.
	<ul style="list-style-type: none"> Current limit reached. Non-linear output from inverter or inverter's PID is enabled. 	<ul style="list-style-type: none"> Slow down the inverter by increasing its acceleration / deceleration time settings. Check that the inverter's output is selected to be linear, and that the inverters own PID loop is disabled.
	<ul style="list-style-type: none"> Fan failed to stop before restart. 	<ul style="list-style-type: none"> Increase the inverter stop time by increasing option parameter 9.3 on the PPC6000 series control.
	<ul style="list-style-type: none"> Control is unstable 	<ul style="list-style-type: none"> Adjust option parameters 9.0, 9.2 and 9.3 on the PPC6000 series control to reduce accuracy & slow down control response. Check Option parameter 9.4 matches the acceleration / deceleration time programmed into the VSD. VSD is current limiting. Increase acceleration / deceleration time in VSD and option parameter 9.4.



In extreme cases, it may be necessary to increase the inverter error tolerance to prevent non-volatile lockouts caused by positioning faults (set option 9.1 = 1). **This must only be changed if an inverter error of ± 55 will not cause unsafe combustion.**

Variable Speed Drive Selection:

Important Note: When selecting a VSD or variable frequency drive (VFD) consideration must be given to the size and weight of the blower wheel. While a “fan” application is by nature a variable torque load, the inertia (weight) of the blower wheel must be considered. Typical HVAC type drives do not speed up or slow down large blower wheels with enough control to operate within the tolerance of the PPC or NX series control. Therefore, a VSD (VFD) with some built in breaking capability, such as a constant torque drive, should be used. At a minimum, if the drive has a constant torque setting, it must be enabled to minimize faults due to drive hunting.

Problem	Possible cause	Suggested action
Oxygen display not available.	No oxygen probe interface unit serial number entered.	Enter serial number into option parameter 30.0
No inlet temperature display	No inlet temperature unit serial number entered.	Enter serial number into option parameter 35.0
Inlet or flue temperature display flashes 'Hi'	Inlet air temperature sensor / O2 probe not installed and wired correctly.	Check wiring.
No efficiency display or efficiency incorrect.	No oxygen display. No inlet temperature display. No calorific value for the current fuel been entered into 35.X?	See 'No oxygen display' See 'No inlet temperature display' Enter the value for the fuel in use.
Oxygen display shows '---'	Probe not heated up yet, or other probe fault.	Check EK45. Check EK73 – must be above 600°C to work.
Oxygen trim will not work	Trim is not operative. Boiler just fired up. Probe calibration values not entered correctly. Probe not heated up yet. Probe installed incorrectly. Set to monitor only. Probe in calibration. Trim being reset. Trim limits set to 0.0% of flow. Trim integral gain set to zero. Commissioning data missing.	Use EK45 and 46 to decide if trim is operative. Check that option 30.5 = 1. Check option parameter 31.1 to 31.4. Wait for the boiler transport time (after ignition). Wait for modulation. Re enter values (options 20.1,20.2) Check EK75 – must be above 600°C to work. Check wiring. Check option parameter 30.5 set to 1. Check option parameter 30.6 set to 0. Check option parameter 30.8 set to 0. Check option parameters 32.X. Check option parameters 33.X are non zero. Check oxygen and flow values been entered for all profile points in the firing range.



6.8 YB110/TSD104 Fault Messages

Due to the increased use of the Nexus Touchscreen in combination with the BurnerLogix, the numbering format for fault messages is formatted as below. The fault numbers are taken from table 7 in the BurnerLogix manual BL-1001-pdf, but with 200 added to the message number. The 200 is added because there are codes associated with the PPC6000 that utilize the lower levels codes. The list of touchscreen alarm codes associated with the BurnerLogix is listed below:

Fault Number	Description
201	T16 M-D LIMIT OPEN-AUTO
202	HOLD FALSE FLAME-STANDBY
203	LOW FIRE PURGE
204	HOLD M-8 LIMIT OPEN-PURGE
205	AIR FLOW OPEN
206	T16 M-D LOW LIMIT-AUTO
207	LOCKOUT FLAME FAIL-PTFI
208	T16 INPUT CLOSED
209	HOLD M-D LIMIT OPEN
210	IGNITION TIMING-PTFI
211	CHECK FLAME SIGNAL-MTFI
212	FLAME SIGNAL - AUTO
213	CYCLE COMPLETE-POSTPURGE
214	STANDBY L1-3 OPEN
215	T21 INPUT CLOSED
216	LOCKOUT M-D LT OPEN-PTFI
217	LOCKOUT LT M-8 LIMIT OPEN
218	LOCKOUT LIMIT M-D OPEN
219	LOCKOUT FLAME FAIL - MTFI
220	LOCKOUT FALSE FLAME
221	LOCKOUT 3-P INTLK OPEN(P)
222	LOCKOUT 3-PINTLK CLOSED
223	HOLD 3-P INTLK CLSED STBY
224	HIGH FIRE PURGE
225	LOCKOUT M-D LT OPEN-MTFI
226	LOCKOUT 3-P INTLK O AUTO
227	LOCKOUT 3-P INTLK O MTFI
228	LOCKOUT 3-P INTLK O PTFI
229	LOCKOUT T13 FVES OPEN
230	LOCKOUT 3-P INTLK O - PP
231	CHECK FLAME SIGNAL-PTFI
232	CHECK M-8 HI LIMIT (HFP)
233	CHECK M-D LOW LIMIT (LFS)
234	FLAME SIGNAL - PTFI
235	HOLD T21 OR CHK LF AUTO
236	FLAME SIGNAL - MTFI
237	LOCKOUT FLAME FAIL AUTO
238	HOLD 3-P INTLK O - PP
239	LOCKOUT FUELVLVE ST CH
263	HIGH WATER
264	LOW WATER
265	HIGH GAS PRESSURE
266	LOW GAS PRESSURE
295	AUX GAS



Fault Number	Description
267	LOW OIL PRESSURE
296	HIGH OIL TEMPERATURE
268	LOW OIL TEMPERATURE
269	LOW ATOMIZING MEDIA
270	HIGH PRESSURE
271	HIGH TEMPERATURE
272	AUX #4 OPEN
273	AUX #5 OPEN
274	AUX #6 OPEN
275	AUX #7 OPEN

Interlock annunciation messages THESE CAN BE MODIFIED BY THE USER

Fault Number	Description
241	HIGH WATER
242	LOW WATER
243	HIGH GAS PRESSURE
244	LOW GAS PRESSURE
292	AUX GAS
245	LOW OIL PRESSURE
256	HIGH OIL TEMPERATURE
246	LOW OIL TEMPERATURE
247	LOW ATOMIZING MEDIA
248	HIGH PRESSURE
249	HIGH TEMPERATURE
250	AUX #4 OPEN
251	AUX #5 OPEN
252	AUX #6 OPEN
253	AUX #7 OPEN
240	AIR FLOW OPEN
294	OP CONTROL OPEN
260	L1-3 AUX #1 OPEN
261	L1-3 AUX #2 OPEN
262	L1-3 AUX #3 OPEN

7 Inverter (variable speed) drives

This manual may cover more than one model in the PPC6000 series. Check for additional information at the end of this chapter.

7.1 System configuration

The PPC6000 control can control one or two inverter drive(s) to control a fuel and/or air drive(s) using a daughter board (fitted within the PPC6000 enclosure). The daughter board controls the inverter(s) using 4-20mA output channel(s). The output(s) are the speed reference signal to the inverter(s). A 4-20mA or encoder input is used to monitor the feedback signal from each inverter, representing the speed of the motor(s).

In addition to the 4-20mA signals, the inverter(s) also require motor start signal(s) that can be taken from the volt-free relay contact(s) on the daughter board, please ensure its function is set correctly using the relevant option parameter.

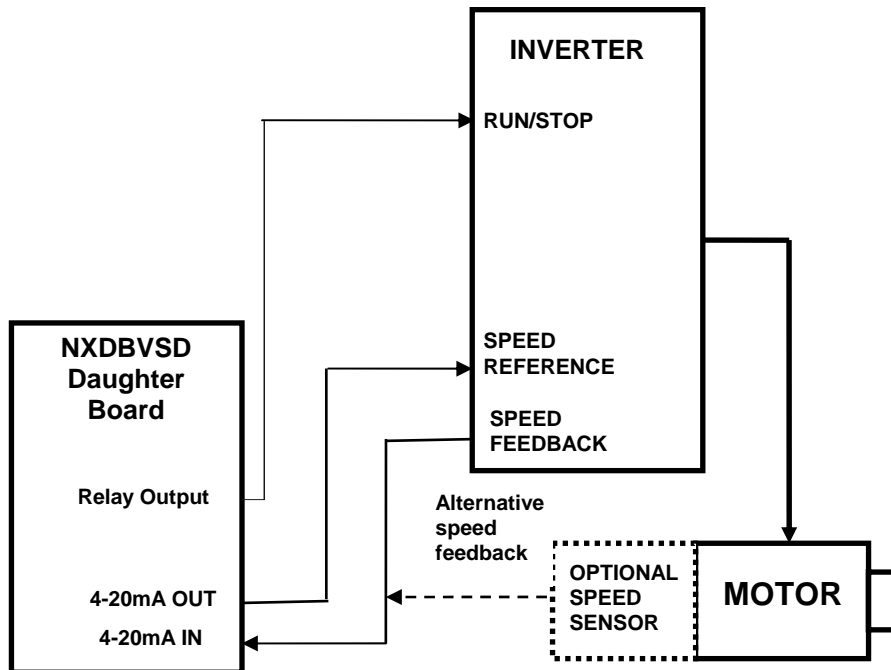

7.2 Description of control method

During start-up of the burner, and before any drives move to purge, the PPC6000 control, moves all drives to their minimum positions by driving servo-motors down and setting an output current of 4mA to each inverter drive. The control waits for the inverter stop time Option 9.3 and then monitors the feedback signals of all drives and compares them to the values which were stored in memory at commission time. If the values do not match those stored in memory, a positioning fault is given and the control performs a non-volatile lockout.

This test proves the feedback from each drive is operating correctly and that the potentiometer (where fitted) has not moved on the servo-motor shaft.

If the test is successful, the control moves all selected drives to their commissioned pre-purge positions (outputs 20mA to all inverters). If the drives cannot achieve their pre-purge positions as set during commissioning, a positioning fault is given and the control performs a non-volatile lockout.

If the burner start-up is successful, the control will control the frequency of the inverter during modulation. A closed loop method is employed, where adjustments to the speed reference signal are made based on the value of the feedback signal.

If the feedback signal from the drive is lost during a run condition (e.g. the loop current drops below 3.5mA or encoder feedback fails) the control will perform a non-volatile lockout.

7.3 Setting up the inverter for use with the PPC6000 series

The PPC6000 will work with most inverters that meet the following criteria:

- 4-20mA speed reference input.
- 4-20mA speed feedback output or use separate encoder.
- Remote run/stop command.
- The inverter must be powerful enough to accelerate / decelerate the motor as required. A good industrial inverter will have a significant overload capability meaning that it can supply well above the rated motor load for some time. This might be something like 150% (or more) for 1 minute. An HVAC inverter typically will have no (or very limited) overload capability and may not be able to accelerate / decelerate the motor quickly without current limiting. This can cause drive position faults when driving to purge.

Analog inputs and outputs:

The analog inputs and outputs (i.e. the 4-20mA reference and feedback signals) on the inverter should be configured in the following way:

- 4-20mA signal (this may be an option parameter and/or a board jumper)
- Speed reference input
- Speed reference output (unless using encoder)
- Minimum frequency 0Hz for 4mA signal
- Maximum reference frequency as required (nominally 60Hz) for 20mA signal
- Maximum feedback frequency same as reference for 20mA signal (unless using encoder)
- No filtering (time constant = 0.0) and no rate limiting

Digital input:

The digital input (i.e. the RUN/STOP) on the inverter should be configured in the following way:

- RUN/STOP from external input (NOT inverter keyboard)
- RUN/STOP active high (i.e. energize to start)



Control characteristics:

The control characteristics of the inverter should be configured in the following way:

- Acceleration and deceleration time approximately 25 - 40 seconds, must be the same.
- Straight line (linear) acceleration between reference points
- Motor to coast to a stop when RUN signal is removed
- No critical frequencies
- DC braking may be needed if motor deceleration is not linear

Motor characteristics:

The following motor characteristics should be entered into the inverter's option parameter list:

- Motor nominal voltage, power, current and frequency (see motor plate and/or supplier data)
- Motor current and temperature limits
- U/F ratio. Use the 'SQUARED' option for fans and pumps.
- Motor slip ratio. Use drive default, if unknown

7.4 Setting up the PPC6000 series for use with a inverter drive

In order to use a inverter drive with a 4-20mA interface, the optional inverter interface daughter board must be fitted. The following steps must then be taken:

- Enter commission mode.
- Enter option set mode.
- Look at the display for the inverter output. The display should show 0 for a feedback signal of zero speed (4mA) and 999 for a feedback signal of 20mA. If using an encoder feedback, the value displayed will depend on the frequency measured by the input on the daughterboard. See note below. If the display is flashing 'High', the feedback signal is less than 3.5mA or more than 21.0mA, the polarity of the wiring is reversed or the encoder is faulty. In all these cases, check the wiring and/or the option parameters on the inverter.
- Monitor the reference signal from the PPC6000 daughter board. With the inverter drive selected, the UP key should increase the current gradually up to 20mA and the DOWN key should decrease the current gradually down to 4mA.
- For encoder feedback signals, run the inverter to its maximum value (normally 50Hz or 60Hz, depending on motor rating / local mains frequency). Look at engineers key 69 or 70 (depending on VSD1 or VSD2). This will give you a measured pulse frequency in Hertz. Add about 2% to 5% to this value (to ensure it is the maximum you would ever expect to get) and enter this value into option parameter 9.5 or 9.6. The displayed value for this drive should now be 950 to 990 (i.e. 95% to 99%). For reliability it should be ensured that the feedback can't go over 99.9% (999). This is why a small percentage is added to the 100% scale value entered in the option parameter. See option parameter 9.5 for a way to check this value using a calculation.
- For the rest of the commissioning procedure, treat the inverter drive in the same way as a motor. The inverter drive has a closed position (4mA), a maximum position (20mA), a pre-purge position, an ignition position and up to 20 profile positions.

8 The oxygen trim option



CAUTION

- Use extreme care when handling the oxygen probe and wear heatproof gloves.
- Ensure the burner is off before removing the oxygen probe from the flue.
- If the boiler is to be operated with the probe removed, fit the blanking cover supplied since dangerous levels of carbon monoxide may be present in the flue.

8.1 Oxygen Pro probe description

The oxygen trim / monitoring function is designed to be used with an NX2012 oxygen probe. This probe offers fast, accurate response and good reliability when mounted in accordance with the guidelines in this section. The probe is available in three different sizes.

8.1.1 Installation of oxygen probe

8.1.2 Mounting the oxygen probe

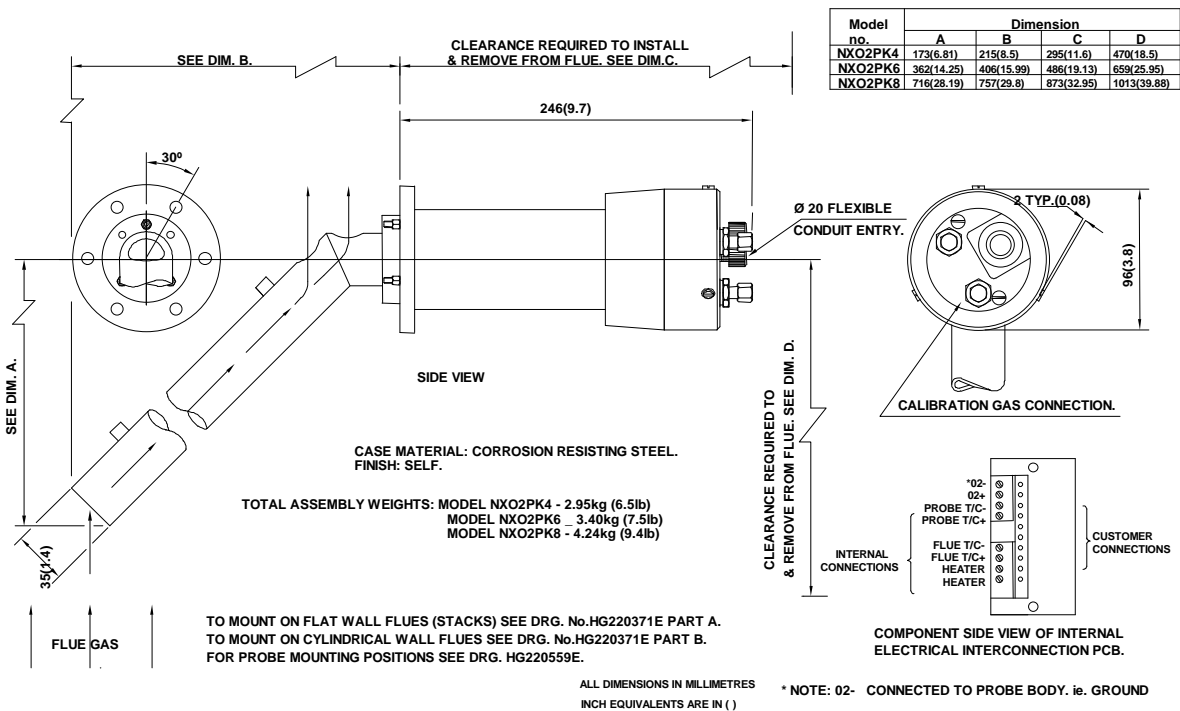

The probe must be mounted in a manner that ensures that the flue gases pass into the gas tube at its open end and out of the tube at the flange end. Furthermore, if possible, the flange should be vertical with the gas tube angled downwards to ensure that particulates do not build up within the sample tube. Probe mounting with the flange horizontal is acceptable. Inverted probe mounting is not acceptable.

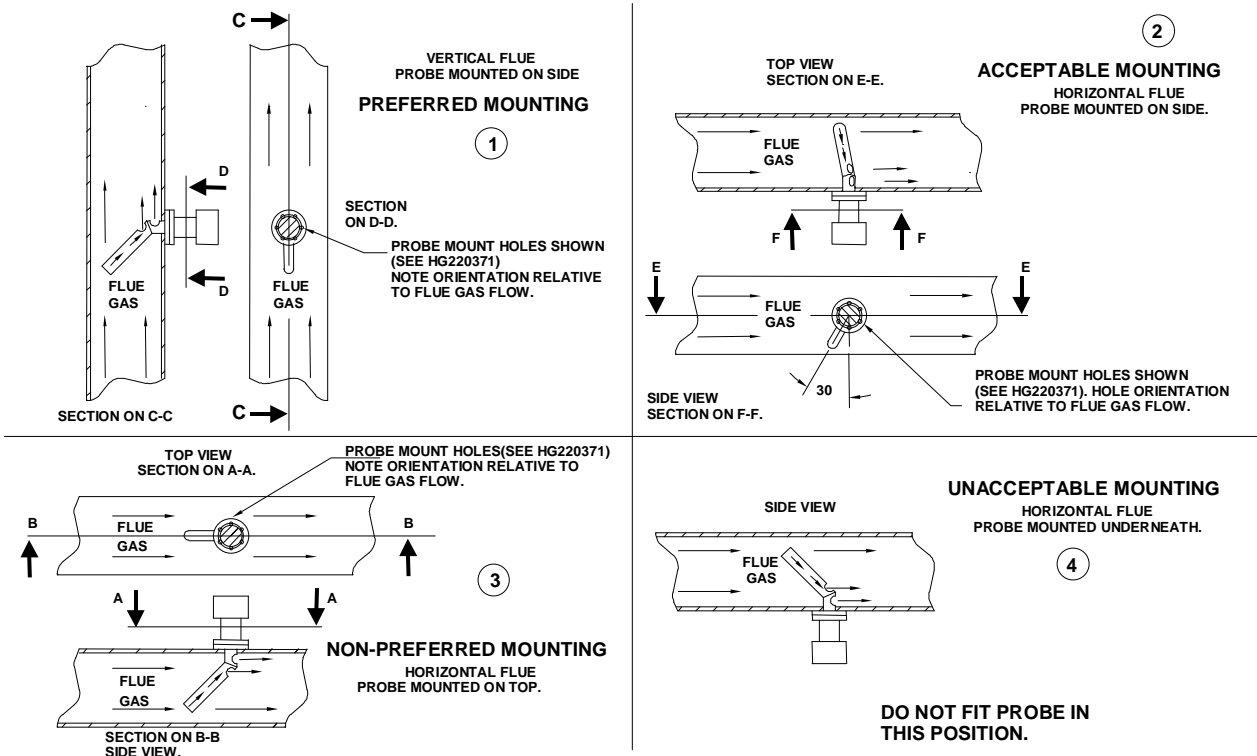

There are two types of flange available (see the drawing over the page). With either flange the vertical center line of the flange shown on the drawing should correspond to the gas flow direction.

6 stainless steel M6 x 20mm socket cap screws are provided for probe attachment.

The probe flange temperature must be maintained at the temperature of the flue wall by repacking or adding lagging, which may have been removed to mount the probe. Sulfate condensation will occur if the flue wall of oil fired boiler falls below approximately 130°C. The sulfate problem does not occur in gas-fired installations, but vapor may cause problems due to condensation if the temperature of the flue gas falls below 100°C.

The maximum flue gas temperature is 1004°F (540°C).

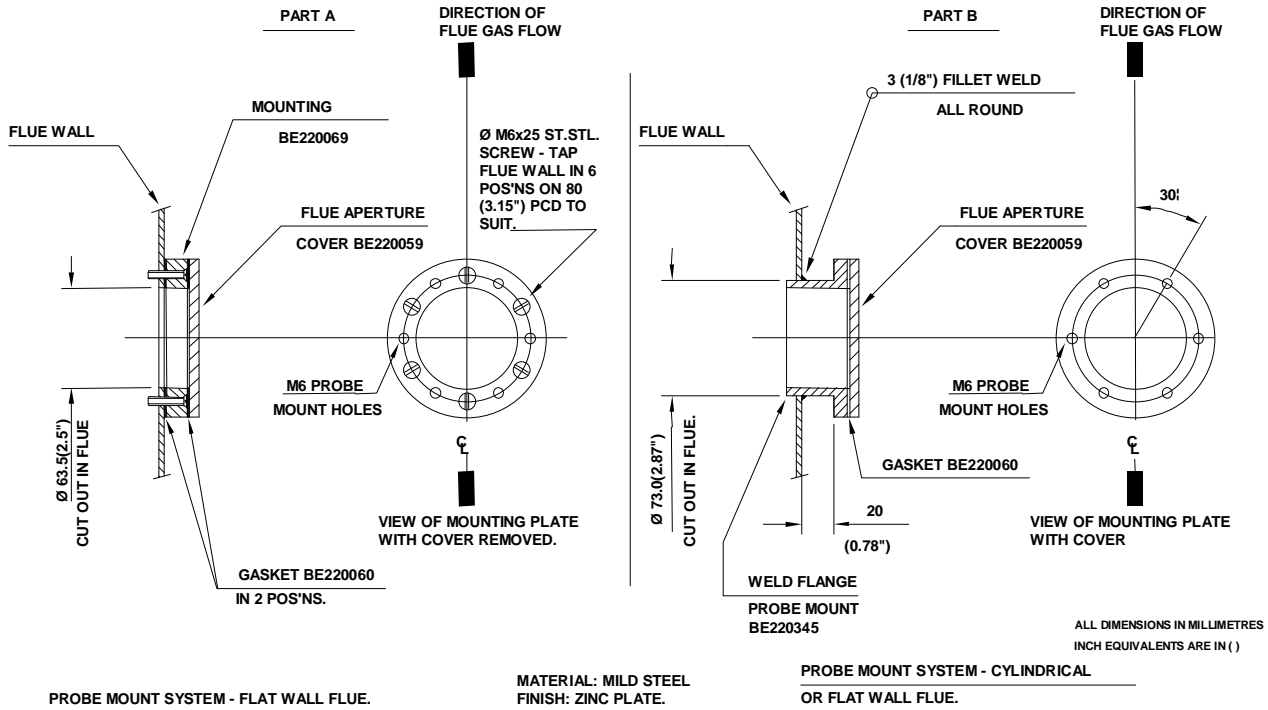

The probe end cap carries a removable 20mm (3/4") flexible conduit fitting to enable probe replacement without wiring. The 2 hexagonal caps visible on the probe rear face are there to cover the calibration gas port and the sample gas port. The latter is merely a tube that passes directly into the flue to enable gas samples to be drawn or flue temperatures to be taken using other instrumentation. Both ports must be kept sealed during normal operation for safety and accurate performance.

9 Appendix

9.1 Calibrating and servicing the oxygen probe

9.1.1 Probe calibration



WARNING

Before proceeding with probe calibration, ensure you have a suitable air and reference gas supply, since both are required to complete the calibration procedure. The calibration gas concentration must be entered as option parameter 30.3 and the oxygen trim function must be disabled using option parameter 30.5. Depending on the system configuration there may be 2 oxygen probes connected to the system, in which case please ensure the calibration gas is being supplied to the correct probe.

If the probe calibration is to be checked while the burner is firing ensure that oxygen limits have not been set (option 38.0) which may cause a burner lock-out to occur while the calibration is being performed.

Proceed with probe calibration as follows:-

1. Enter option set mode using the site or adjust ratio passcodes. (see section 5).
2. Select option parameter 30.3 and set the value to be the same as the concentration of the calibration gas to be used.
3. Select option parameter 30.5 in the display and ensure it is set to 0.
4. Select option parameter 30.6 and change the value of the parameter to 1 and then press ENTER. The oxygen trim function will be disabled and the system is in "calibrate air" mode.
5. Apply the calibration air supply to the oxygen probe calibration port. Once this has been connected, select option parameter 30.1, and view the probe offset value.
6. Allow the offset value to settle and then select option 30.6 and increment the value to 2 and then press ENTER. The oxygen trim function will remain disabled and the system will be in "calibrate reference gas" mode.
7. Apply the calibration gas to the oxygen probe calibration port. Once this has been connected, select option parameter 30.2, and view the probe gain value.
8. Once this has been connected, select option parameter 30.2, and view the probe gain value.
9. Before enabling the oxygen trim function using option parameter 30.5, ensure that the calibration gas supply is removed from the probe and that the probe calibration port end cap is fitted, to prevent incorrect oxygen measurements.

9.1.2 Oxygen Probe Filter Testing

The filter can be tested without removing the probe from the flue. Before proceeding, ensure the oxygen trim function is disabled using option parameter 30.5.

The check is carried out by passing air at 350cc/min (22cu. ins/min) into the calibration gas connection on the rear of the probe adjacent to the flexible conduit fitting, and checking the pressure drop.

The pressure drop can be found by connecting a manometer or similar in the flow line to the calibration gas connection, as shown below.

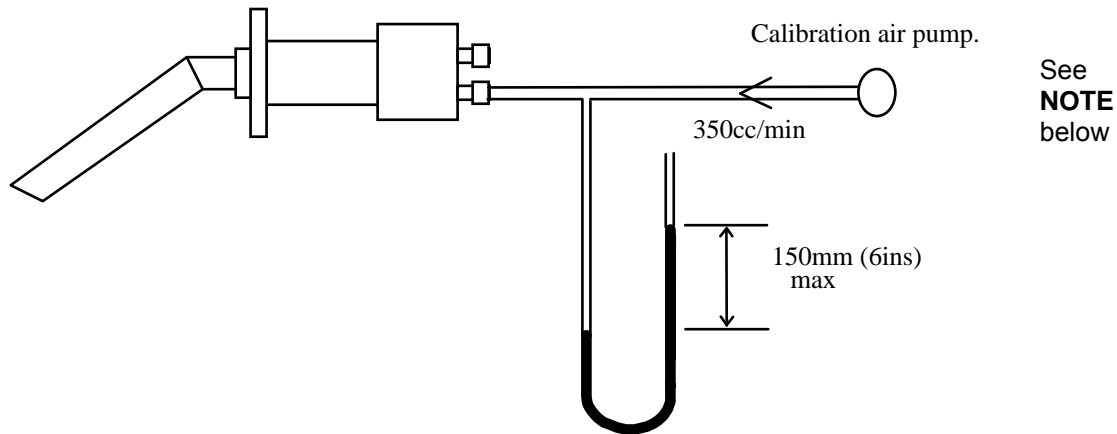

If the pressure is 150mm (6ins) water gauge or more the filter must be replaced.

NOTE: Fireeye offers a calibration pump kit, part number CAP-1. See your local Fireeye Distributor for details.

9.1.3 Removing the oxygen probe from the flue



CAUTION

- Before attempting to remove the probe, switch off the system and the boiler. It is essential to switch the burner off since dangerous levels of carbon monoxide may be present in the flue.
- Since the body of the probe will be hot, it will be necessary to use heat resistant gloves to hold the probe.
- Do not operate the boiler without the probe or blanking plate fitted since dangerous levels of carbon monoxide may be present in the flue.

The Fireeye Oxygen Probe is retained in the flue by six 6mm stainless steel socket head cap screws.

- Loosen the 3 screws securing the probe end cap and slide the cap down the flexible conduit. Use caution the end cap unit may be hot.



- Access is now available to the electrical terminations. Remove the plug from the printed circuit board allowing the flexible conduit fitting to slide out of the probe body complete with the plug.

Since the body of the probe will be hot, it will be necessary to use heat resistant gloves to hold the probe.

- Remove the six retaining screws. The probe can be extracted from the flue taking care not to damage the sealing gasket.
- The only customer replaceable items are the flue thermocouple and oxygen filter.
- If it is necessary to operate the boiler while the probe is removed, the blanking plate supplied with the equipment must be fitted to the probe flange.
- Refitting is the reverse of the removal procedure. Ensure that the screws are tightened sequentially.

9.1.4 Filter replacement

- Remove the oxygen probe from the flue as detailed in section 9.1.3, and unscrew the insulating flue thermocouple mounting blocks from the snout.
- Before removing the three 6mm stainless steel nuts and spring washers which retain the snout, it is important to hold the body horizontal or snout down to prevent soot or other deposits from falling into the probe body.
- When the 3 nuts and washers have been removed, the snout can be drawn off the mounting studs to allow the captive filter assembly to be removed.
- The new filter assembly (part number 19-117) can then be inserted into the snout, beveled side inwards.
- The snout can be refitted, ensuring that the filter locates into the probe body. The retaining washers and nuts should be tightened sequentially to seal the filter assembly to the flange.

9.1.5 Probe mounted flue thermocouple replacement.

- Remove the oxygen probe from the flue as detailed in section 9.1.3.
- Disconnect the internal connections to the thermocouple.
- Unscrew the 2 thermocouple-mounting blocks from the probe snout to allow the thermocouple to be straightened.
- Remove the hexagonal nut securing the thermocouple into the probe and withdraw the thermocouple through the probe body.
- Refitting is the reverse of the removal procedure. The electrical connection and polarity of the thermocouple are detailed on the following page.

Fireeye O2 Probe Connector

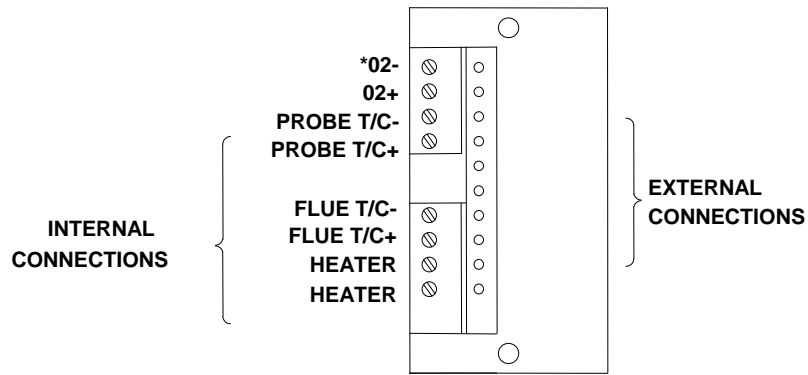

COMPONENT SIDE VIEW OF INTERNAL
ELECTRICAL INTERCONNECTION PCB

9.2 Troubleshooting inverter problems

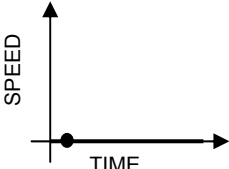
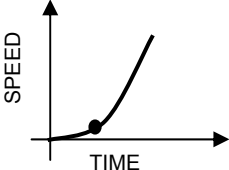
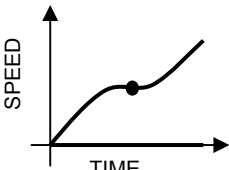
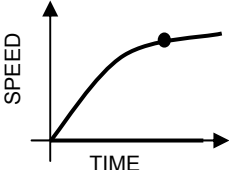
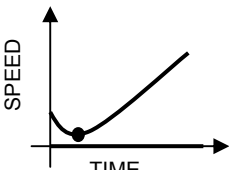
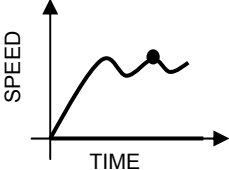
Problem	Possible Cause	Solution
	<ul style="list-style-type: none"> Inverter does not start because it does not receive a RUN signal. 	<ul style="list-style-type: none"> Ensure that the inverter receives a RUN signal from the burner controller at the same time as the PPC6000.
	<ul style="list-style-type: none"> Inverter has a slow start. Late RUN signal. Non-linear output from inverter or inverter's PID is enabled 	<ul style="list-style-type: none"> Ensure that the inverter's slow start feature is disabled. Ensure that the inverter receives a RUN signal from the burner controller at the same time as the PPC6000. Check that the inverters output is selected to be linear, and that the inverters own PID loop is disabled.
	<ul style="list-style-type: none"> Current limit reached Noise 	<ul style="list-style-type: none"> Slow down the inverter by increasing its acceleration / deceleration time settings. Check cable screens.
	<ul style="list-style-type: none"> Current limit reached. Non-linear output from inverter or inverter's PID is enabled. 	<ul style="list-style-type: none"> Slow down the inverter by increasing its acceleration / deceleration time settings. Check that the inverters output is selected to be linear, and that the inverters own PID loop is disabled.
	<ul style="list-style-type: none"> Fan failed to stop before restart. 	<ul style="list-style-type: none"> Increase the inverter stop time by increasing option parameter 9.3 on the PPC6000.
	<ul style="list-style-type: none"> Control is unstable 	<ul style="list-style-type: none"> Adjust option parameters 9.0, 9.2 and 9.3 on the PPC6000 control to reduce accuracy & slow down control response. Check Option parameter 9.4 matches the acceleration / deceleration time programmed into the VSD. VSD is current limiting. Increase acceleration / deceleration time in VSD and option parameter 9.4.

In extreme cases, it may be necessary to increase the inverter error tolerance to prevent safety shutdowns caused by positioning faults (set option 9.1 = 1). **This must only be done if an inverter error of ± 55 will not cause unsafe combustion.**



9.3 PID Tutorial

PID Adjustment

The PPC6000 utilizes an advanced algorithm in order to maintain setpoint over a variety of load conditions. This three term PID can be infinitely adjusted to suit almost any application. The operator should have a basic understanding of the relationship between the three terms - proportional, integral and derivative.

Proportional

Typical older modulating systems employ only proportional control. This would be similar to the slide wire type found on most steam boilers. When using only a proportional control the system rarely achieves setpoint as the burner firing rate is lowered as the pressure comes up. At some point the input meets the actual demand and the pressure no longer raises or lowers, thus an offset between desired setpoint and actual operating pressure occurs. The only time the pressure and setpoint are the same is if the actual load equals the lowest firing rate of the burner, this is rare. An example of proportional only set up might be; Setpoint is 100 PSI, proportional range is 10 PSI. That is low fire is at 100 PSI, high fire is at 90 PSI with a 1:1 relationship in between, e.g.: 95PSI equals 50% rate. A good starting point for the "P" value, in most cases is about 10% of setpoint.

Integral

If the integral term is turned on, the control compares the actual pressure against setpoint at an adjustable interval. If there is an offset, the firing rate is increased by a small percentage until the next interval. This will continue until the pressure equals the setpoint. The same routine occurs as the pressure rises above the setpoint. Too much or too little integral will cause over and undershoot of the setpoint. Integral is set in seconds per repeat in the PPC6000.

For example, if the P were set at 10 psi with a boiler setpoint of 100 psi, the burner would first remain at high fire until the pressure reached 90 psi, and then start to modulate down. If the load was equal to 50% firing rate, the pressure would stall at 95 psi. Adding an "I" value of 10 would ramp the output up to 100% (high fire) in 10 seconds, assuming no change in the boiler pressure. Setting an "I" value of 300 increases the output up to 100% (high fire) in 5 minutes (300 seconds). As the boiler reaches setpoint, the same timing effect occurs above setpoint. Therefore, too much "I" can cause over/under shoot as loads change. Too little "I" may cause rapid hunting. A good starting point for the "I" value, in most cases is 50.

Derivative

Enabling the derivative has the effect of sensing the rate of change in the process variable (pressure or temperature) and increasing or holding up the firing rate output despite the integral term. This in effect amplifies the output to anticipate the effect of a sudden change in load demand. Derivative acts inversely when the setpoint is exceeded. Derivative is set in seconds on the PPC6000. A good starting point for the "D" value, in most cases is 2.

Start with a P value of about 10% of setpoint, and value of 50 seconds and a D value of 2 seconds. After observing the operation through normal load swings, adjust each value, usually one at a time, and observe the results. When making a change it is recommended the value be doubled or halved to determine which direction you need to go. Bear in mind, the burner should not continuously hunt or swing to maintain the desired setpoint. It is normal for a slight over and undershoots of setpoint during serious load changes. The values for the PID's are found at option parameters 21.2, 21.3 and 21.4 for setpoint 1 (PID1), and 22.2, 22.3 and 22.4 for setpoint 2 (PID2). These values are adjustable using the **Site Passcode 154**.



9.4 Combustion Profile Setup Guideline

It is safe to say that most burners do not have fuel and air control devices that have linear flow characteristics. When commissioning the Fireye Nexus/PPC parallel positioning system, the following procedure will help assure the maximum benefit will be realized. Before starting the installation, the commissioning engineer should try to verify the maximum combustion air damper (flow) position so as to know the “target” high fire position. This can be done by rotating the original jack shaft before it is removed and measuring the air damper opening. If possible, it should be marked for reference.

There are 24 points available for creating a profile, P0 (closed/off) to P23 (high fire). The first three positions, P0, P1&P2 are required to reach ignition which may or may not be the same as low fire (P3). After establishing a good low fire and entering the values at P3, the display will now indicate P4 with the drives at the P3 position. At this time the main air drive or drives should be increased a minimum of one degree or until the observed oxygen level increases approximately 1.0 to 1.5%, **do not press enter at this time**. At this point the fuel drive should be increased slowly to bring the oxygen level back down to the desired level and entered at this time. Following this procedure from low to high fire will yield a relatively linear profile. That is to say, each position will increase the fuel and air flows by nearly equal amounts from low to high fire, thus making the profile somewhat linear. This will aid in setting up O2 trim. NOTE: On very high turndown burners, the O2 increase may need to be greater in higher firing rates to avoid running out of ‘P’ positions.

The PPC6000’s **Engineers Key 44** (see section 6.6.2) displays the actual O2 value of the Fireye oxygen probe when fitted. It should be noted that the reading of the Fireye probe will be between 1 and 1.5% **lower** than most portable combustion analyzers. This is normal and due to the difference between wet and dry samples. Bear in mind the PPC6000 will trim to the value of the Fireye probe, not to the value of a portable analyzer. Also, when using adjust ratio mode to re-tune an existing profile, do not simply change the O2 target value. Adjust the fuel or air to achieve the desired O2 setpoint, then enter *that* value.

For example:

Position	Air Drive	Fuel Drive	Observed O2%	Increased O2%
P3	5.0	15.0	7.0	9.0
P4	7.5	18.0	7.0	9.0
P5	12.0	22.0	6.0	8.0
P6	17.0	28.0	5.0	7.0
P7	24.0	33.0	4.0	6.0
P8	29.0	38.0	4.0	6.0
P9	35.0	45.0	4.0	6.0
P10	43.0	55.0	3.5	5.0
P11	53.0	67.0	3.5	5.5
P12	66.0	79.0	3.5	5.0
P13	80.0	88.0	3.5	High Fire

NOTE: The angular change in the air drive position required to achieve the 1.0 to 1.5% increase in observed oxygen level may increase as the burner fires at higher rates. This is normal as the air “damper” will not likely be linear. When approaching high fire large increases in the air drive servomotor travel may be required to increase the oxygen reading by 1.0 to 1.5%. As a rule, this should be avoided as the burner is potentially “out of air” and in so doing, the effective input to the boiler will be negligible. This would also affect the operation of oxygen trim should this option be used.



9.5 Fireeye PPC6000 Efficiency Calculations

Fireeye PPC6000 controls can display calculated combustion efficiency.

For the displayed efficiency to be meaningful the correct values for Calorific Value and Hydro-Carbon Ratio for the fuel in use must be entered in the related Fireeye PPC6000 option parameters.

Efficiency may be displayed as Net or Gross.

The calorific value of a fuel is the heat given out when unit quantity of the fuel is completely burnt, any fuel containing hydrogen has two calorific values, these being the gross or higher calorific value and the net or lower calorific value.

The gross calorific value is the heat given out when unit quantity of fuel at 15.6 °C (60 °F) is completely burnt and the products of combustion are cooled to 15.6 °C (60 °F), as such any steam present in the products of combustion due to the burning of the hydrogen will be condensed to water, giving up its latent heat of vaporization and some of its sensible heat loss.

This heat recovery is not possible under practical conditions and the net value is approximately the gross value less this quantity of heat which is usually taken at 2.45 MJ/Kg of steam formed.

Therefore if gross efficiency is required, gross calorific value is used and the latent heat of vaporization due to any steam present in the products of combustion is taken as a loss in the efficiency calculation.

However, if net efficiency is required, net calorific value is used and therefore the latent heat of vaporization due to any steam present in the products of combustion is already taken into account, so the latent heat loss in the efficiency equation is set to zero.

In addition when considering gross efficiency it is normal to also take account to the boiler radiated heat loss. This will be a fixed heat loss from the boiler shell in the order of 1% to 3% of the boiler high fire output, which if the burner is operating with say a 6 to 1 turn down would equate to a 6% to 18% loss at low fire.

Comparison of Fireeye PPC6000 with Hand Held Equipment

When comparing the efficiency as displayed by the PPC6000 control and other equipment it is important to ensure the same parameters are being used by both units.

- 1) Ensure the efficiency is selected to be either net or gross in both units, hand held equipment usually uses net since it is rare for hand held equipment to have knowledge of the boiler firing rate to include the radiated heat loss.
- 2) Ensure the same calorific value is being used by both units.
- 3) Ensure the same value for hydro-carbon ratio is being used by both units.
- 4) Ensure the ambient (inlet) temperature being measured by the hand held is physically at the air intake to the burner, as it should be for the PPC6000. If the hand held equipment does not measure the inlet temperature, ensure the value it is using for ambient air temperature is representative of the application.
- 5) Ensure the flue temperature and oxygen value are being measured at the same location in the flue to reduce the possibility of errors being introduced due to stratification of the flue gas.
- 6) Fireeye O₂ probes measure oxygen in the flue without extracting and drying flue gases. If attempting to compare the oxygen values being measured by the PPC6000 and a hand held equipment ensure the value being given by the hand held is corrected from a dry to a 'wet' value, as it will almost certainly be measured as a 'dry' value. The water being removed to prevent damage to the sensor cells in the hand held equipment.



When comparing the values of efficiency displayed by the PPC6000 equipment and hand held equipment, **first** check that the following values are the same or very close:

- 1) Inlet temperature.
- 2) Flue gas temperature.
- 3) Calorific value
- 4) Hydro-carbon ratio.
- 5) Oxygen value (after making correction for dry to wet on the hand held).
- 6) Selection of net or gross.
- 7) If a radiated heat loss value is being included ensure the hand held equipment has corrected the value for the current firing rate of the burner.

Other points to remember:

In a typical package boiler radiation losses are usually in the order of 3%, blow down losses typically 2% and flue gas losses 15% to 20%.

Giving a typical overall efficiency of $100 - 3 - 2 - 20 = 75\%$.

The major area for attention to improve boiler efficiency is the flue gas losses, with the object of minimizing excess air, within the bounds of safe and reliable boiler operation. O2 Trim is the best tool for ensuring consistent optimum combustion and minimization of excess air.

The PPC6000 ensures consistent fuel: air ratios.

The Fireeye O2 Trim option continuously compensates for changes that affect efficient combustion due to such variables as: viscosity of liquid fuels, density of gaseous fuels, changes in temperature of fuels, changes in gas and oil pressures, worn and damaged burners, dirty burners, scaling of boiler tubes, ambient temperature, barometric pressure and tramp air.

9.6 Typical Wiring Diagrams

Typical Wiring Diagram / YB110

IMPORTANT: Low Voltage (vertical terminal strips)
 All low voltage circuits and communication wire must be fully shielded braided type wire of the specified gauge and number of conductors. **Table 2.6.1-A provides the only approved wire for this application. No "or equal" is provided. Use of wire not approved by Fireeye may VOID warranty.**
 All wiring to terminal block "PA" & "PB" as well as to any optional daughter board (e.g. VSD) and the Power/CANbus wiring to the display, must be fully shielded braided wire per Table 2.6.1-A.
Under no circumstances should these input/outputs be connected to mains potential. Connection of any voltage above 5 volts to these terminals will damage or destroy the unit.

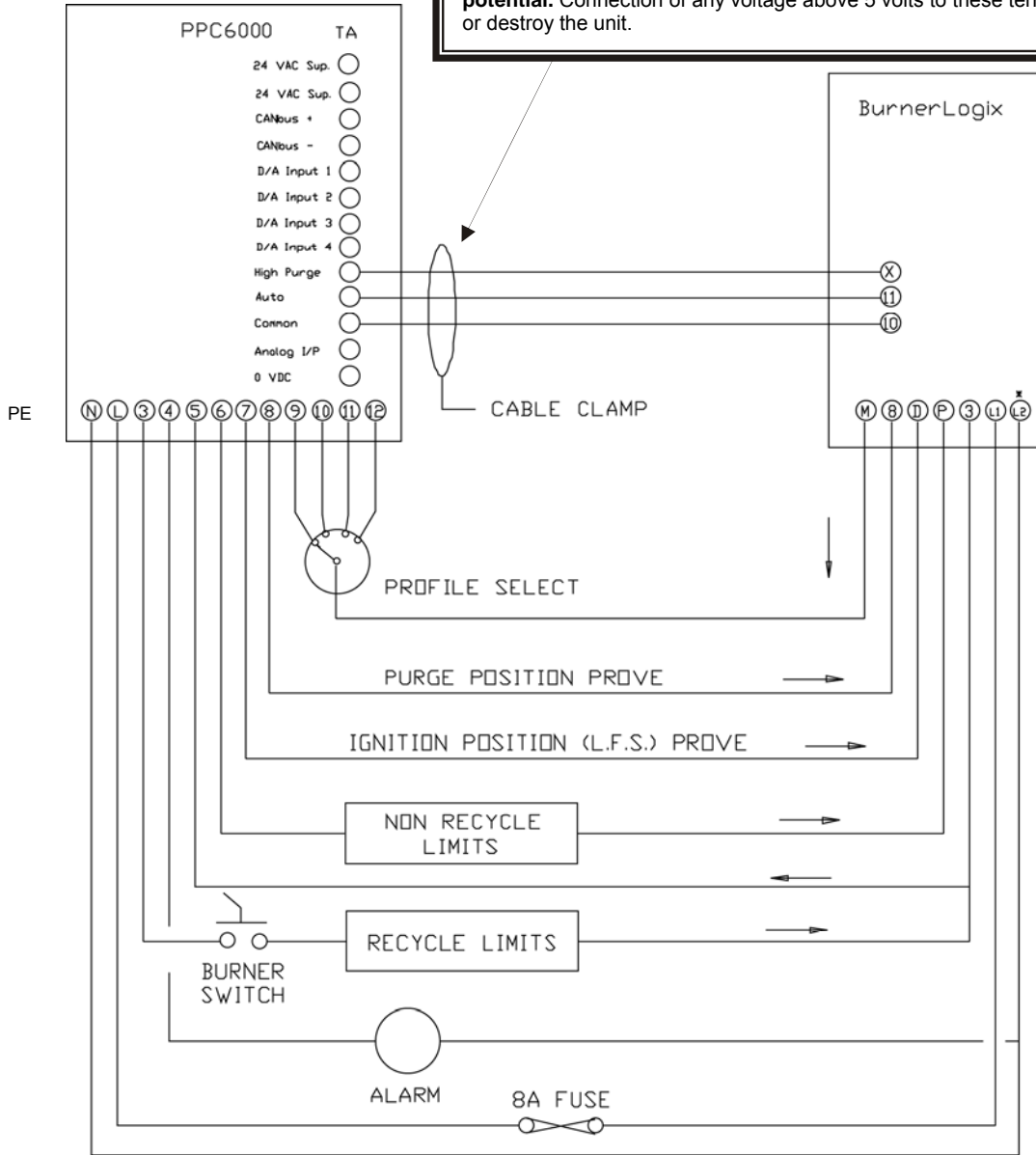

CAUTION
 Due to the possibility of High Frequency electrical noise, **BOTH** ends of the shielded signal wire to the VSD **must** be grounded.

* Refer to bulletin BL-1001 for remaining BurnerLogix I/O connections. A complete schematic can be found at <http://fireeye.net/pdf/JC1109.pdf>.

** **Note:** PE7 and PE8 provide purge and low fire position signals to the flame safeguard control. These outputs **MUST NOT** have a load greater than 30mA (i.e. relays, lamp, etc.), damage to the PPC6000 will result.

Typical Wiring Diagram / E110

IMPORTANT: Low Voltage (vertical terminal strips)
 All low voltage circuits and communication wire must be fully shielded braided type wire of the specified gauge and number of conductors. **Table 2.6.1-A provides the only approved wire for this application. No "or equal" is provided. Use of wire not approved by Fireye may VOID warranty.**

All wiring to terminal block "PA" & "PB" as well as to any optional daughter board (e.g. VSD) and the Power/CANbus wiring to the display, must be fully shielded braided wire per Table 2.6.1-A.

Under no circumstances should these input/outputs be connected to mains potential. Connection of any voltage above 5 volts to these terminals **will** damage or destroy the unit.

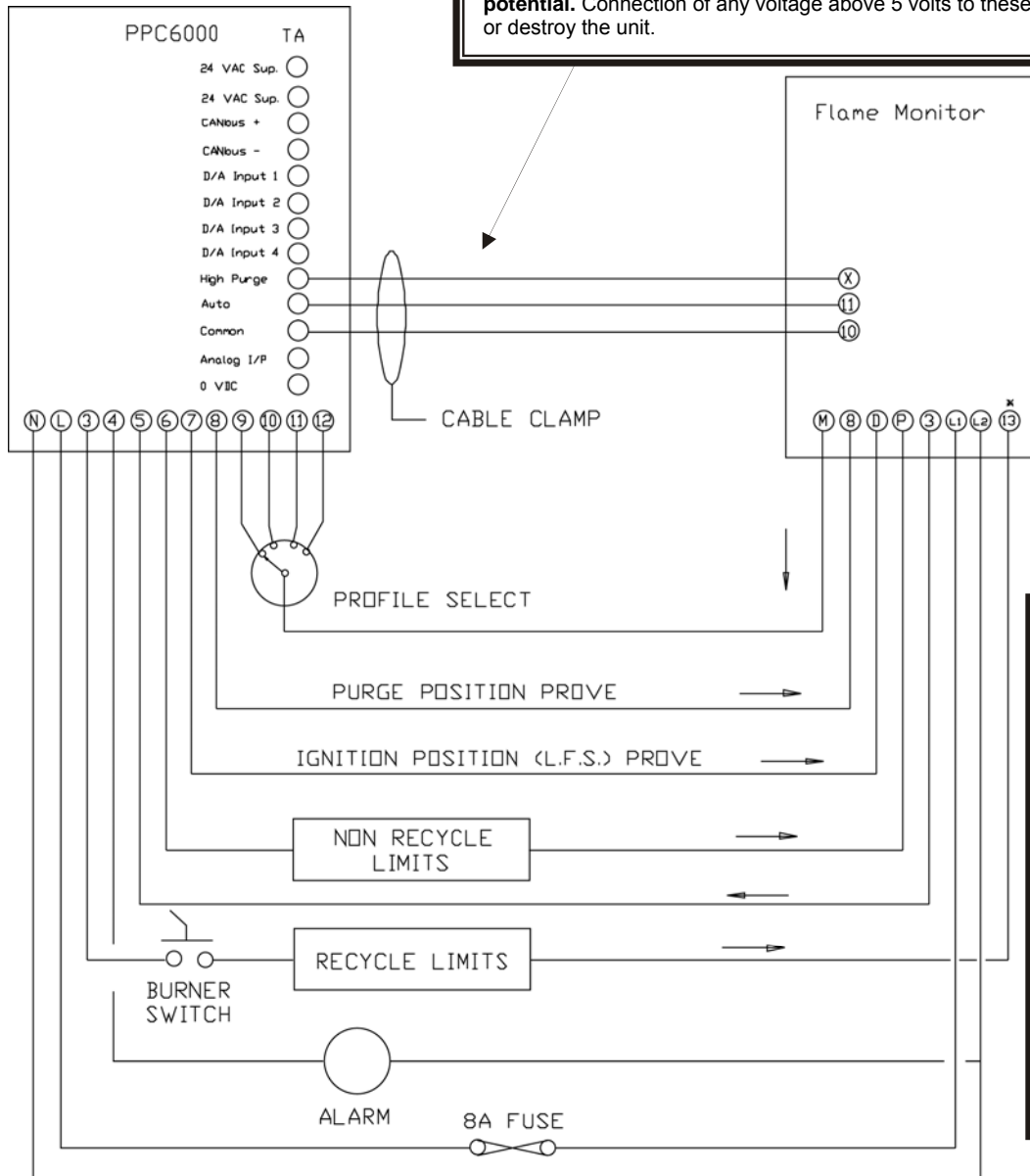

CAUTION
 Due to the possibility of High Frequency electrical noise, **BOTH** ends of the shielded signal wire to the VSD **must** be grounded.

* Refer to bulletin E-1101 for remaining Flame Monitor I/O connections. A complete schematic can be found at <http://fireye.net/pdf/JC1109.pdf>.

* **Note:** PE7 and PE8 provide purge and low fire position signals to the flame safeguard control. These outputs **MUST NOT** have a load greater than 30mA (i.e. relays, lamp, etc.), damage to the PPC6000 will result.

NOTE: These templates should be measured for accuracy as distortion from printing may occur. See section 2.0 for details.

PPC 6000

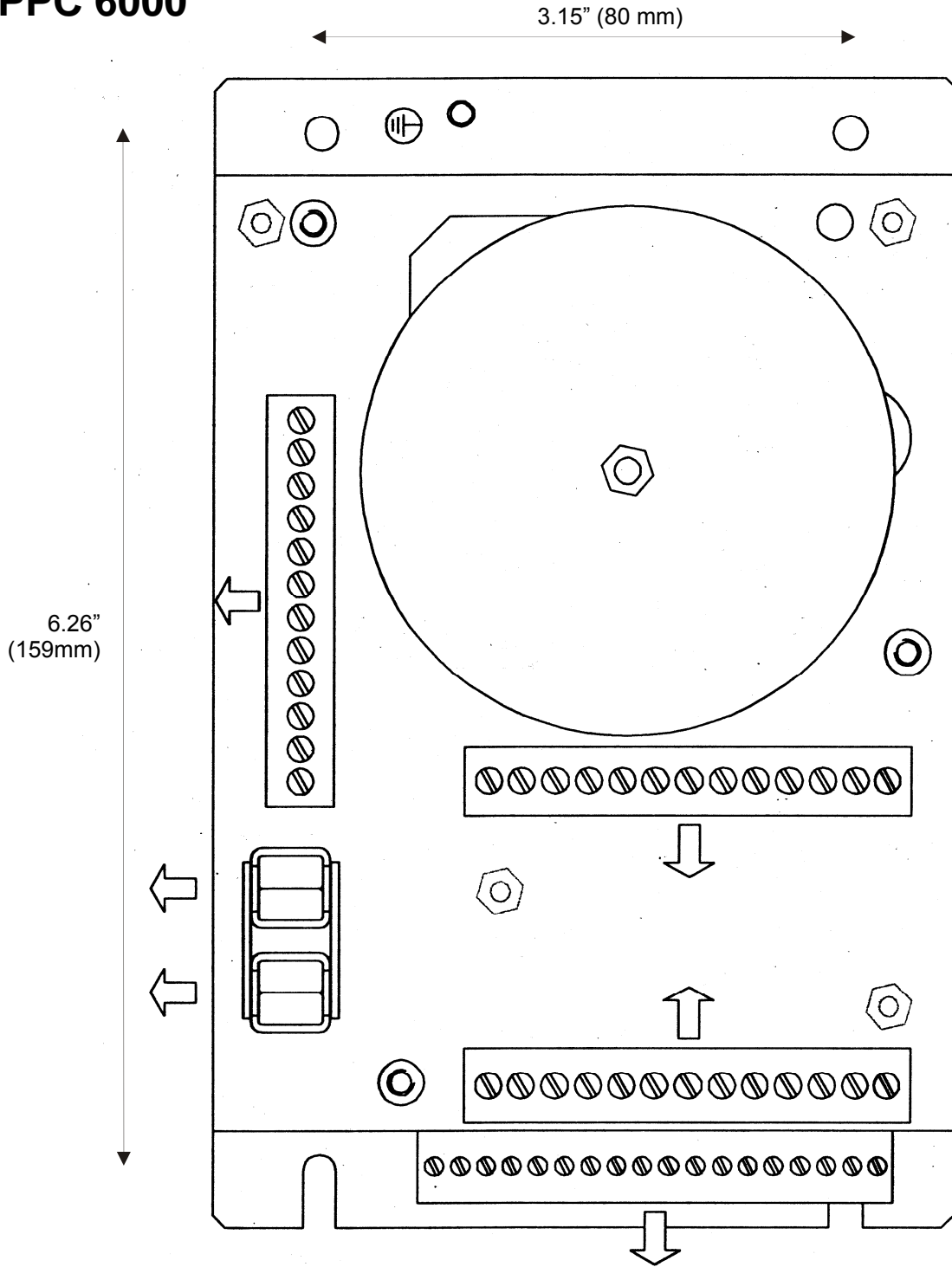



NX600, NX610

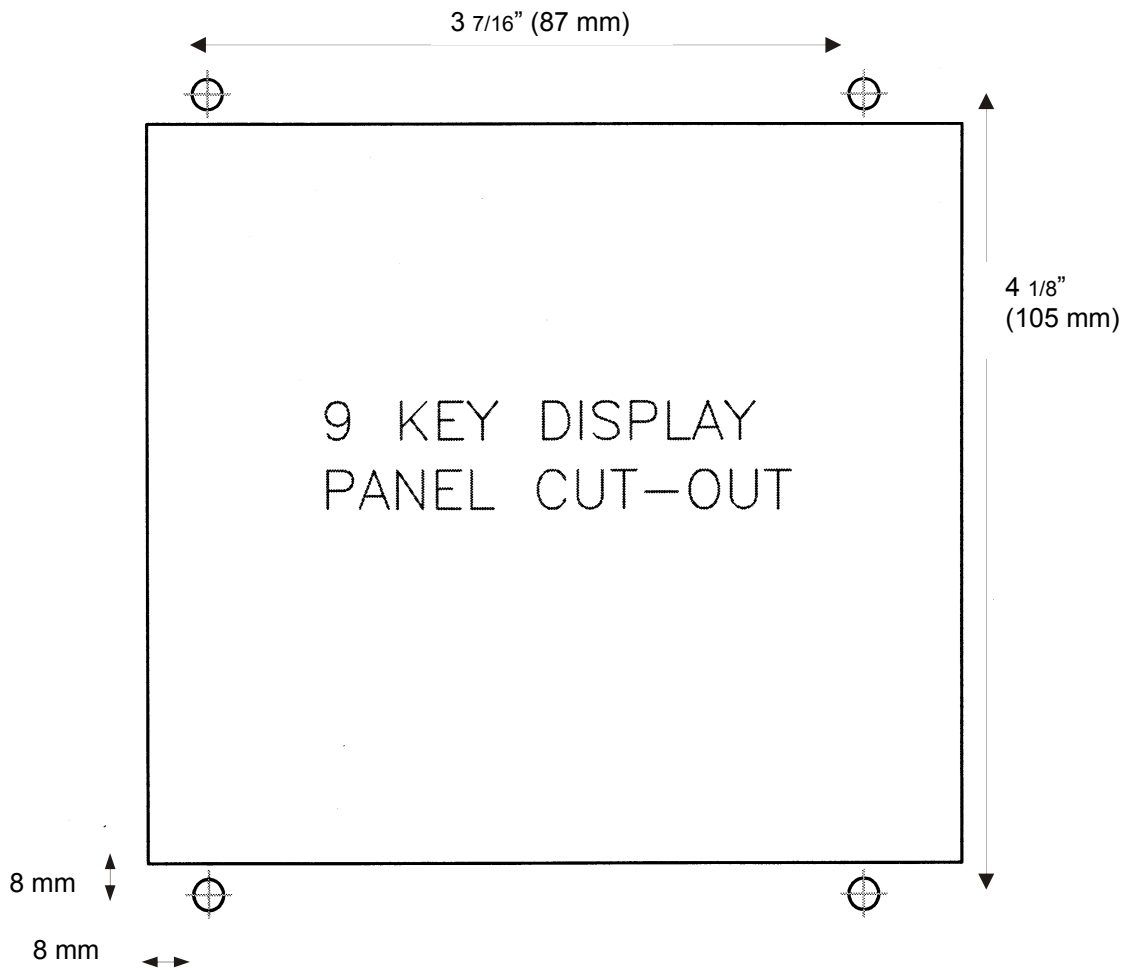

TEMPLATE: Remove to use

NOTE: These templates should be measured for accuracy as distortion from printing may occur. See section 2.0 for details.



NX02INT

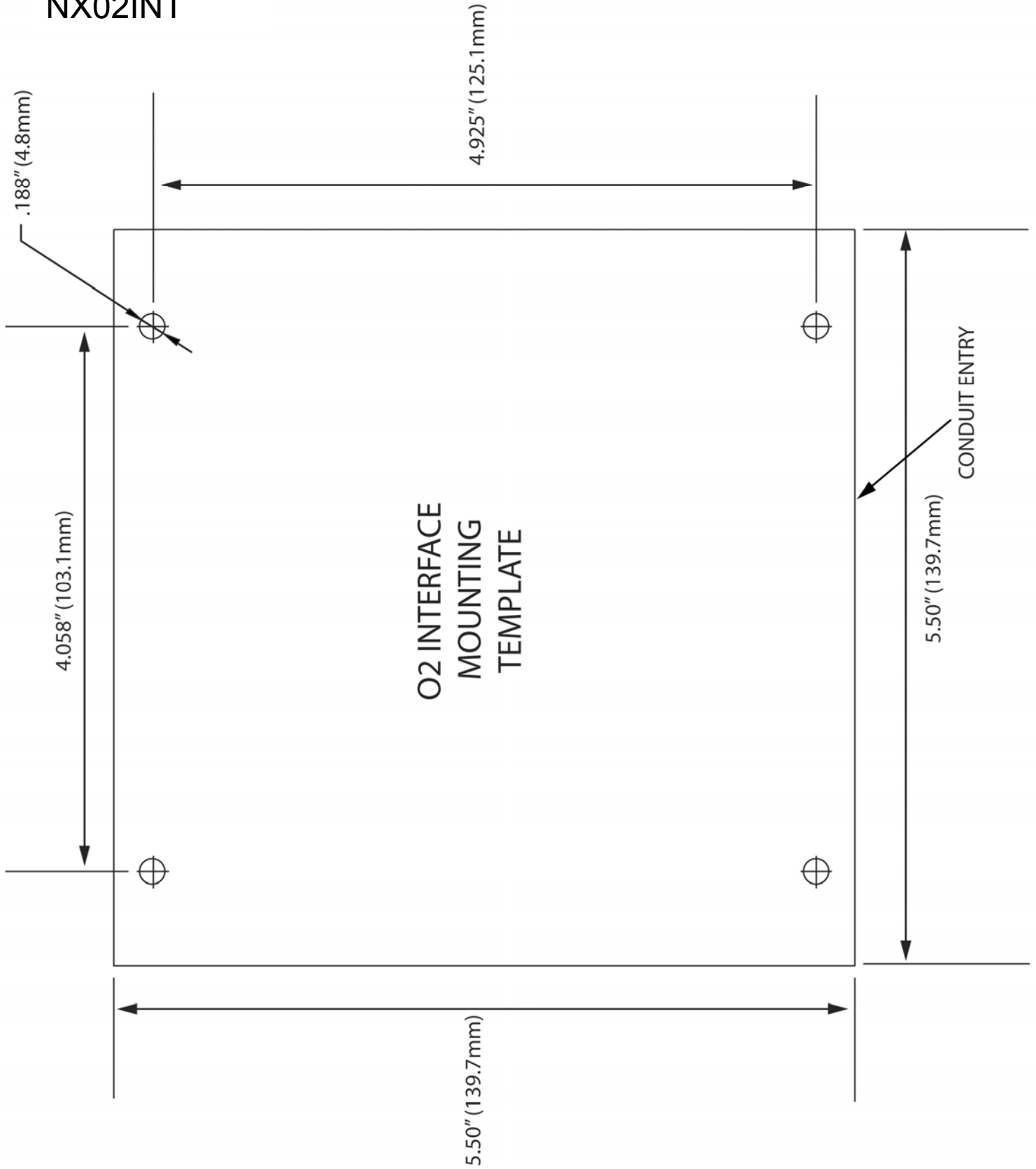

TEMPLATE: Remove to use

NOTE: These templates should be measured for accuracy as distortion from printing may occur. See section 2.0 for details.



9.7 Operator's Guide

9.7.1 Introduction

This guide can be downloaded from the Fireeye web site at www.Fireeye.com. Search bulletins for NXOG-6001 under the Nexus products family.

As an operator there are generally only a few items of interest as far as operating the Nexus PPC6000. They are:

- Setting the system's operating pressure or temperature.
- Adjusting the cut in or cut out value.
- Manually modulating the boiler.
- Resetting the control after a safety shut down.
- Finding the Fault that caused the shut down.

All of the other options and adjustments should be done by the combustion technician, as changes to certain parameters could result in an unsafe operating mode.

9.7.2 General

The Nexus display and keypad allows the operator (or combustion technician) access to all setpoints and option parameters for commissioning and operating the Nexus PPC6000. The keys are labeled with their primary function on the key, their secondary function under the key. E.g.: COM/ENTER.

Several levels of passwords protect the integrity of the control. These passwords are numbers entered by using the up/down arrow keys after pressing the COM (commissioning) key. To enter the password start by pressing the COM (commissioning) key. You will have 30 seconds to reach the password value and press the ENTER (COM) key.

9.7.3 Password

The only password an operator should require is the "site Passcode." This can be set as a number from 0-999. The factory default number is 154. The site Passcode can be changed if desired, however, this requires the use of a higher-level Passcode.

Warning: Should the Passcode be changed and forgotten, the PPC6000 will have to be reprogrammed by using the higher-level Passcode. Until then, no adjustments are possible.

Operating Pressure – PID (setpoint) 1 or (2)*

*** NOTE: () Parentheses indicate setpoint 2 option parameter. E.g. Day/night.**

To set or adjust the boiler's operating pressure follow steps 1 thru 7:

1. Press the **COM** key.
2. Use the **UP** key to raise the value to **154** (or new Site Passcode, if changed).
3. Press the **ENTER** key. This is the same key as **COM**.
4. If the display shows the angular positions of the servomotors, press the **MODE** key to change to option parameters. Using the up or down key move to **OPTION 21.1 (22.1)**. This is the control value the Nexus will modulate the burner to maintain.



5. Use the left or right arrow key to move the cursor to the lower portion of the display, then using the up/down arrow key change the setting.
6. Press the **ENTER** key to accept the new setpoint.
7. To exit and return to the normal run mode, press the **RUN** key followed by the **ENTER** key.

Note: The next time you enter the site password you will return to the last option selected.

9.7.4 Adjusting Cut IN and Cut OUT

Follow steps 1 through 3 above.

4. If the display shows the angular positions of the servomotors, press the **MODE** key to change to option parameters. Using the up or down key, move to **OPTION 21.6 (22.6) for Low Limit (Cut In)** or **21.7 (22.7) for High Limit (Cut Out)**. This is the control value the Nexus will start/stop the burner after reaching the cut in/out value. This value is a differential value when option parameter 21.5 (22.5) is set at 2. That is, it is subtracted/added from/to the operating setpoint. Once set, this value will follow any change in the setpoint programmed in option 21.1 (22.1). These values are actual values if 21.5 (22.5) are set to 1. (see table below)

Option parameter 21.5 (22.5) value	Meaning
0	No limits. The burner will run until another method is used to switch it off.
1	Absolute limit. The values entered in option parameters 21.6 (22.6) and 21.7 (22.7) are the actual limit values.
2	Deviation limit. The values entered in option parameters 21.6 (22.6) and 21.7 (22.7) represent a deviation (i.e. offset) from the setpoint 1 control value. This means that if the setpoint control value is changed, the limits are automatically changed correspondingly.

5. Use the left or right arrow key to move the cursor to the lower portion of the display then - using the up/down arrow key, change the setting.
6. Press the **ENTER** key to accept the new setpoint.
7. To exit and return to the normal run mode press the **RUN** key followed by the **ENTER** key.

Deviation Example – setting Opt 21.5 to 2

To maintain 100 psi on the boiler, cut out at 115 psi, cut in at 95 psi.

NOTE: Opt 15.5 – Boiler High Safety Limit – If this option is set to a non-zero, *exceeding* this value causes a *non-volatile lockout*.

Opt 21.1 (22.1)* set to 100 psi
 Opt 21.5 set to 2
 Opt 21.6 (22.6)* set to 15
 Opt 21.7 (22.7)* set to 5

RESULTS:

Boiler OFF (Cut Out) at..... 115 psi
 Boiler ON (Cut In) at 95 psi
 Boiler maintains (Setpoint)..... 100 psi via PID

Changing ONLY the Setpoint –

Opt 21.1 (22.2) change to 60 psi

NEW RESULTS from Setpoint Change:



Boiler OFF (Cut Out) at 75 psi
Boiler ON (Cut In) at 55 psi
Boiler maintains (Setpoint) 60 psi via PID

NOTE: NEW I (integral time) and D (derivative time) values - Option Parameters 21.3(22.3) and 21.4(22.4), may be required to achieve desired results.

Absolute Example – setting Opt 21.5 to 1:

Opt 21.1 (22.1)*set to..... 100 psi
Opt 21.5set to..... 1
Opt 21.6 (22.6)*set to..... 115
Opt 21.7 (22.7)*set to..... 95

RESULTS:

Boiler OFF (Cut Out) at 115 psi
Boiler ON (Cut In) at 95 psi
Boiler maintains (Setpoint) 100 psi via PID

Changing ONLY the Setpoint –

Opt 21.1 (22.2)change to..... 60 psi

NEW RESULTS from Setpoint Change:

Boiler OFF (Cut Out) at 115 psi
Boiler ON (Cut In) at 95 psi
Boiler maintains (Setpoint) 60 psi via PID

NOTE: NEW Cut In and Cut Out values as well as new I (integral time) and D (derivative time) values - Option Parameters 21.3(22.3) and 21.4(22.4), may be required to achieve desired results.

In BOTH examples (*) represents PID2

9.7.5 Manual Modulation

Pressing **AUTO/MAN** key toggles the burner in and out of manual or automatic modulation. To place the boiler in manual from automatic no password is required.

1. Press the **AUTO/MAN** key
2. Use the up/down arrow keys to set the firing rate.
3. Press the **AUTO/MAN** key again to place in automatic

Note: The firing rate will be shown on the display. This function can be disabled via option parameter 1.1. To do so requires the suppliers (highest) passcode.

9.7.6 Resetting the Control



To reset the Nexus, the **MUTE/RESET** key will have to be pressed and held for three seconds to first silence (mute) the alarm and then a second press for three seconds to clear the fault. A prolonged key press will do both.

If for some reason the Nexus detects a fault, the cause of the fault will be displayed if still present. If not displayed, pressing the **ENGINEERS** key once will reveal the fault, a second press will reveal the fault and subset in the upper right hand corner. The **ENGINEERS** key is hidden behind the Fireeye® logo on the display. Pressing the logo will show the EK # to the right of which will be the fault # and any subset. Using the up/down arrow keys scrolls through the EK #'s to view other information. For specific Engineer's Key listing see Section 6.6 of Fireeye Bulletin PPC6001.

9.7.7 Fault and Fault Finding

Should the Nexus determine a fault has occurred that required the burner be shut down, the bottom portion of the display will indicate the cause. Pressing the **ENGINEERS** key will display more information, which will be found in the upper right of the display. See Section 6.0 of Fireeye Bulletin PPC-6001 for more details. Using the **ENGINEERS** key the last 33 faults or limits can be reviewed. The fault history begins with the most recent which can be found after **EK200** and will be date and time stamped. There are three aspects to each record; when it was reset, when it changed from a fault to a cleared fault and when the fault occurred. The portion of the record at the "**Fxx**" will also include the subset if any. **See Fault Subsets.**

Many of the faults detected and displayed by the unit will cause a safety shutdown of the burner. Other faults will be displayed as a warning, but operation of the burner will not be affected.

All fault numbers are prefixed by a letter. This letter describes the status of the fault:

- F - This means that a fault (e.g. PSU calibration fault) has occurred and is still present. The fault may be internal or external to the unit.
- L - This means that an alarm limit fault (e.g. smoke level exceeding the high limit) has occurred and is still present.
- C - This means that a fault or alarm limit did occur but has been cleared.

For example:

- F60 - Means fault 60 has occurred and still exists.
- L75 - Means alarm limit 75 has been exceeded and is still being exceeded
- C73 - Means fault or alarm limit 73 has occurred but has subsequently been cleared.

When the unit is in a safety shutdown state both the controlled shutdown triac and safety shutdown relay will be turned off, to prevent the burner from firing.

9.7.8 Fault subsets

As an aid to fault finding, most faults have a *fault subset* that gives additional information about the type of fault or what the burner was doing when the fault occurred. Where applicable, the subsets are given in the fault listing in section 0 of Fireeye Bulletin PPC6001. For details of how to view a subset, refer to Section 6.0 of Fireeye Bulletin PPC6001.



9.7.9 Fault listing

For specific Fault listing see Section 6.5 of Fireeye Bulletin PPC-6001.

9.7.10 PID Tutorial

PID Adjustment

The PPC6000 utilizes an advanced algorithm in order to maintain setpoint over a variety of load conditions. This three term PID can be infinitely adjusted to suit almost any application. The operator should have a basic understanding of the relationship between the three terms; proportional, integral and derivative.

Proportional

Typical older modulating systems employ only proportional control. This would be similar to the slide wire type found on most steam boilers. When using only a proportional control the system rarely achieves setpoint as the burner firing rate is lowered as the pressure comes up. At some point the input meets the actual demand and the pressure no longer raises or lowers, thus an offset between desired setpoint and actual operating pressure occurs. The only time the pressure and setpoint are the same is if the actual load equals the lowest firing rate of the burner, this is rare. An example of proportional only set up might be; Setpoint is 100 PSI, proportional range is 10 PSI. That is low fire is at 100 PSI, high fire is at 90 PSI with a 1:1 relationship in between, e.g.: 95PSI equals 50% rate. A good starting point for the "P" value, in most cases is about 10% of setpoint.

Integral

If the integral term is turned on, the control compares the actual pressure against setpoint at an adjustable interval. If there is an offset, the firing rate is increased by a small percentage until the next interval. This will continue until the pressure equals the setpoint. The same routine occurs as the pressure rises above the setpoint. Too much or too little integral will cause over and undershoot of the setpoint. Integral is set in seconds per repeat in the PPC6000.

For example, if the P were set at 10 psi with a boiler setpoint of 100 psi, the burner would first remain at high fire until the pressure reached 90 psi, and then start to modulate down. If the load was equal to 50% firing rate, the pressure would stall at 95 psi. Adding an "I" value of 10 would ramp the output up to 100% (high fire) in 10 seconds, assuming no change in the boiler pressure. Setting an "I" value of 300 increases the output up to 100% (high fire) in 5 minutes (300 seconds). As the boiler reaches setpoint, the same timing effect occurs above setpoint. Therefore, too much "I" can cause over/under shoot as loads change. Too little "I" may cause rapid hunting. A good starting point for the "I" value, in most cases is 50.

Derivative

Enabling the derivative has the effect of sensing the rate of change in the process variable (pressure or temperature) and increasing or holding up the firing rate output despite the integral term. This in effect amplifies the output to anticipate the effect of a sudden change in load demand. Derivative acts inversely when the setpoint is exceeded. Derivative is set in seconds on the PPC6000. A good starting point for the "D" value, in most cases is 2.

A rule of thumb is; start with a P value of about 10% of setpoint, an I value of 50 seconds and a D value of 2 seconds. After observing the operation through normal load swings, adjust each value, usually one at a time, and observe the results. When making a change it is recommended the value be doubled or halved to determine which direction you need to go. Bear in mind, the burner should not continuously hunt or swing to



maintain the desired setpoint. It is normal for a slight over and undershoots of setpoint during serious load changes.

The values for the PID's are found at option parameters 21.2, 21.3 and 21.4 for setpoint 1 (PID1), and 22.2, 22.3 and 22.4 for setpoint 2 (PID2). These values are adjustable using the **Site Passcode 154**.

9.7.11 The startup / shutdown stages are as follows:

Stage no.	Stage name	Description
0.	Non-volatile lockout / safety shutdown	<p>The burner is held in this state until all faults are removed.</p> <p>The 'safety shutdown' output (PE5 – PE6) will be open. The 'controlled shutdown' output on PE3 will also be OFF during this time, however if the burner was running when the fault occurred, the 'safety shutdown' output will have opened first.</p>
1.	Burner off (EK18)	<p>The burner is checked to make sure that it has switched off completely. The fuel/profile select inputs must all go OFF when the burner is switched off (or at the end of post-purge). This provides a feedback to confirm that the burner is off, and ensures that this control is always synchronized with the burner controller.</p> <p>The 'controlled shutdown' output on PE3 will be OFF during this time, however the 'safety shutdown' output PE5 – PE6 will be closed during this time.</p> <p>The control will advance to status 2 when:</p> <ul style="list-style-type: none"> - All fuel/profile select inputs are OFF - The 'boiler status' is equal to 1 (call for heat). See engineers key 18. - The 'AUTO' input (PA10 – PA11) is OFF (open).
2.	Wait for purge (EK5) (EK11-14) (EK31)	<p>The 'controlled shutdown' output on PE3 will be switched on, to tell the burner controller there is a call for heat.</p> <p>This control waits for a fuel/profile select signal on one of the (line voltage) terminals PE9, PE10, PE11 or PE12 and a purge request (HIGH input, PA9 - PA11 closed. This input is low voltage). This would normally come from the burner controller.</p> <p>If the fuel/profile select input is removed (PE9, 10, 11 or 12), the control will immediately move to status 1.</p>



Stage no.	Stage name	Description
3. & 4.	N/A	<p>Not Applicable to PPC6000</p> <p>Note: Statures 3 and 4 are reserved for a gas valve proving system and are not implemented on this control. This control will advance directly to status 5 once the conditions above have been met.</p>
5.	Prove closed positions (EK80-89)	<p>The fuel and air motors are moved down until they are stopped by the 'closed position' micro-switches in the servos. The final positions are compared with the closed positions stored in memory, and must be within $\pm 5^\circ$ of the stored values otherwise the control will lockout.</p> <p>Variable speed drives must read zero. (4 mA)</p> <p>When all drives have stopped moving, the control will advance to status 7. The 'HIGH' input (PA9 to PA11) still must be made during this time.</p> <p>If the fuel/profile select input is removed (PE9, 10, 11 or 12), the control will immediately move to status 1.</p>
6.	N/A	<p>Not Applicable to PPC6000</p> <p>Note: Status 6 is reserved for air pressure detection, and is not implemented in this control. This function must be provided by the burner controller.</p>
7.	Moving to Purge	<p>The selected motors are moved up towards the purge position. When the drives have all stopped, the control moves to status 8.</p> <p>If the fuel/profile select input is removed (PE9, 10, 11 or 12), the control will immediately move to status 1.</p>
8.	Pre-purge	<p>The controller confirms all required drives are at their purge positions, and gives a 'purge proved' signal by providing (line voltage) to terminal PE8 (high-fire-switch).</p> <p>The control will remain in this status until the burner controller signals the end of pre-purge by breaking PA11 – PA9 ('HIGH' input).</p> <p>If the fuel/profile select input is removed (PE9, 10, 11 or 12), the control will immediately move to status 1.</p>
9.	Move to ignition positions	<p>The selected motors are moved to their ignition positions. The 'purge proved' signal is switched off. When the drives have all stopped moving, the control advances to status 10.</p> <p>If the fuel/profile select input is removed (PE9, 10, 11 or 12), the control will immediately move to status 1.</p>



Stage no.	Stage name	Description
10.	Ignition	<p>The controller confirms all required drives are at their ignition positions, and gives an 'ignition proved' signal by supplying line voltage to terminal PE7 (low-fire-switch).</p> <p>The controller will hold the drives at their respective ignition positions until the signal to modulate is received from the burner controller. This is performed by closing the circuit on PA10 – PA11 (AUTO input).</p> <p>If the fuel/profile select input is removed (PE9, 10, 11 or 12), the control will immediately move to status 1.</p>
11-14	N/A	<p>NOTE: Statuses 11 to 14 control the light-up sequence of the burner and are provided by the 'burner controller' device used for the application. This control will jump from status 10 to status 15 when the light up is completed.</p> <p>Not Applicable to PPC6000</p>
15.	Moving to low fire	<p>Once the AUTO signal is received the fuel and air motors are moved from their ignition positions to their low fire positions. These positions may or may not be the same as the ignition positions. The 'ignition prove' terminal PE7 (low-fire-switch) is switched off.</p> <p>If the fuel/profile select input is removed (PE9, 10, 11 or 12), the control will immediately move to status 1.</p> <p>Once the drives have reached their low fire positions, and an AUTO signal is received (PA10 - PA11), the control will advance to status 16.</p> <p>IF Option 23.0 (warming limit) is enabled, drive will remain at low fire until time set by Option 23.0 expires.</p> <p>NOTE: terminal PE7 will always be OFF during status 15.</p>



Stage no.	Stage name	Description
16.	Modulation (EK33)	<p>Once the fuel and air motors reach their low fire positions, they are modulated according to the demand placed on the burner.</p> <p>In this burner status the 'high-fire-switch' and 'low-fire-switch' outputs (PE8 & PE7) will come on at high and low fire respectively and may be used for indication purposes.</p> <p>If a 'HIGH' input is provided by closing PA9 – PA11, this control will move to status 17.</p> <p>If the 'AUTO' input is removed by opening PA10 – PA11, this control will modulate down to low fire then jump to status 15. Note: Terminal PE7 will not be energized in this case. This may be used to provide a low fire post purge, or a low fire hold function.</p> <p>If the fuel/profile select input is removed (PE9, 10, 11 or 12), the control will immediately move to status 1.</p> <p>If this control wishes to turn the burner off (there is no call for heat, for example), it will open the 'controlled shutdown' relay, removing power from PE3. It will remain in modulation status however, until one of the conditions above is met.</p>
17.	Move to post-purge	<p>The selected motor(s) are moved to their purge positions all others are moved to their closed positions. When the drives have all stopped, the control will move to status 18.</p>
18.	Post-purge	<p>The controller confirms all required drives are at their purge positions, and gives a 'purge proved' signal by providing (line voltage) to terminal PE8 (high-fire-switch).</p> <p>The control will remain in this status until the burner controller signals the end of pre-purge by breaking PA9 – PA11 ('HIGH' input), or the fuel/profile select input is removed (PE9, 10, 11 or 12). In either case, the control will immediately move to status 1.</p>

9.7.12 Non-volatile lockout

Non Volatile lockouts cannot be cleared without operator intervention and are remembered in the event of power being removed from the control.

A non-volatile lockout will occur under the following conditions:

- In any stage the interface signals are incorrect.
- In stages 5, 7 and 8, stages 10-16 (inclusive) and stage 18 if a motor is not in the correct position
- In any stage, if an internal or external fault not previously mentioned occurs which may affect the safe operation of the burner (see section 0 of Fireye Bulletin PPC6001)



9.8 Fireeye Nexus Combustion Curve

Site: _____

Date: _____

Profile: _____

Fuel: _____

NAM E	Drive 0	Drive 1	Drive 2	Drive 3	Drive 4	Drive 5	Drive 6	Drive 7	Drive 8	Drive 9	O2	CO	NOx
P 0													
P 1													
P 2													
P 3													
P 4													
P 5													
P 6													
P 7													
P 8													
P 9													
P 10													
P 11													
P 12													
P 13													
P 14													
P 15													
P 16													
P 17													
P 18													
P 19													
P 20													
P 21													
P 22													
P 23													

Notes: PID Setup: P = I = D =

10 Function Block Programming Details

Below is an *overview* of the capabilities of the function block program – Abacus. This overview is intended to give the user insight into what can be accomplished with function block programming.

NOTE: For a more complete description on Abacus, see Fireye Bulletin NXAB-1001.

Introduction to Fireye's Abacus Programming Software

1.1. Introduction

Abacus is a powerful software package that is used to program Fireye PPC6000 and NX6100 series controls. The software allows the user to define special functions such as draft or feed water control to be implemented within the control using standard or optional inputs and outputs. The designer can assign option parameters and engineer's key's as well as levels of password protection to the custom options. After the program is completed it is then uploaded to the control via optional Fireye Comfire software. The user can run the optional program by selection in option parameter 00.4. The factory default program is always available as a back up by deselecting the user program.

The programs are entered graphically by drawing and connecting blocks on schematic pages. These schematics are then sent to the controls where they operate as a program.

Here is a preview of a simple program.

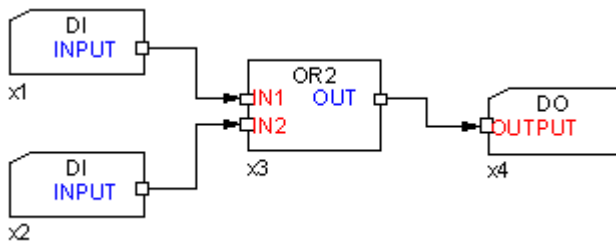

Briefly, this program will give a relay closure (digital output, DO) if either of the digital inputs (DI-1 or DI-2) is activated. These inputs could come from relay closures on other equipment.

The details of which inputs are read, which output is activated are covered in Fireye Bulletin NXAB-1001.



WARNING: ON NO ACCOUNT MUST THE PROGRAMMABLE BLOCKS BE USED FOR ANY SAFETY CRITICAL FUNCTION.

The operation of the burner management / drive positioning system in the basic control is fail-safe however the programmable blocks system is not. If the programmable blocks are used to control a safety related item (such as water level) then appropriate external limit checking must be provided to maintain safety if the user program should fail to operate.

After loading and executing the Abacus software and following the required steps, a blank schematic page will appear. The toolbar on the right hand side of the main abacus window is used to place blocks on the screen.

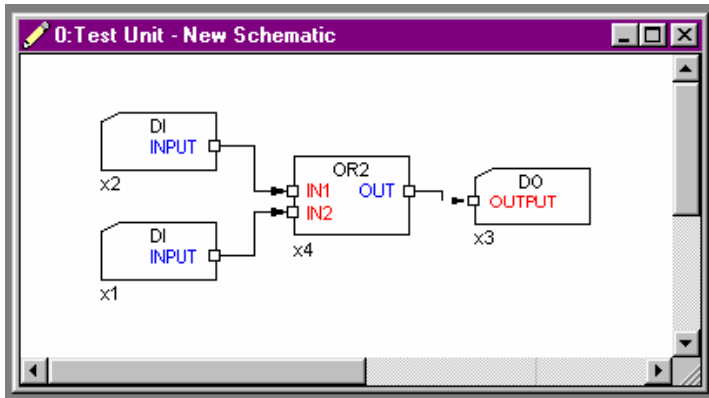

First draw the blocks, then connect them.



Using the toolbar, click the top button **twice** to bring up two digital input blocks.

You will notice that the blocks always appear in the middle of the visible window. In this case, one is on top of the other. Move these to the left hand side of the screen by dragging with the mouse. To do this, you must click within the block area, not on one of the pins (square nodes).

You will also notice that each block has an x-number by its bottom left corner. This is simply a reference number for the block. Each block on a page will have a unique x-number.



On the toolbar, click the second button from the top **once**. This will give up a digital output block. Move this towards the right hand side of the screen.



On the toolbar, click the OR gate symbol **once** to create an OR function block. Move this to the middle of the other blocks, roughly as on the example.

To connect the blocks together:

- Move the mouse pointer over the output pin of the block the signal is to originate from.

The output pins are those which have a description shown in blue. They are always on the right hand side of a block. The term 'output pin' refers to the output from this block to the next one, not an output from the control itself.

- Press and hold the left mouse button.
- Move the mouse pointer over an 'input pin' of the block the signal is to arrive at, keeping the left mouse button pushed.
- Release the mouse button. A link should be drawn.

Links must always be drawn like this - starting from an output, finishing at an input.

Note: Some of the blocks have a sloped top-left corner and some do not. These blocks require parameters.

1.3.5. Entering Parameters

Some function blocks require parameters to be entered to work. The sloped top-left corner can easily identify these blocks. The digital input and output blocks on the previous page are examples of this.

- Double click one of the digital input blocks on the left hand side of the schematic.

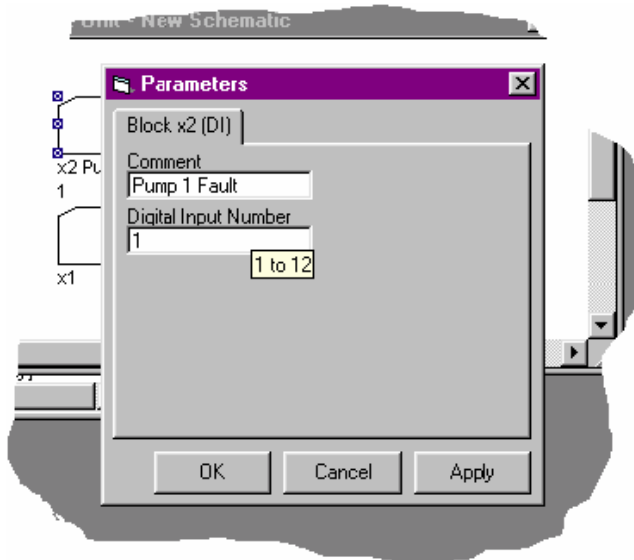

The parameters window should now open and show the two parameters to be entered.

If you are unsure about a parameter, look in the documentation (Bulletin NXAB-1001) for a complete description of the function.

Another useful feature is the 'tip text'. If you move the mouse pointer over the edit field but do not click it, a tip will appear. This will give the allowable range for the parameter if applicable.

The first parameter here is called 'Comment'. This is text used to describe a function purely for documentation purposes.

- If you wish, you may leave comment blank, but for illustration enter some text such as 'Pump 1 Fault' in this example.

The second parameter here is the actual digital input number to use. This is how the system knows which terminals to read the input voltage from.

- Enter a number '1' for the input number parameter.

Pressing 'OK' will transfer these new parameters to the block and close the parameters window. Pressing 'Cancel' will discard the parameters you've just entered. Pressing 'Apply' will transfer the new parameters to the block and leave the parameters window open. This is useful when entering / reviewing the parameters for several blocks.

- Click 'Apply'.
- While leaving the parameters window open, click on the other digital input block. You may need to move the parameters window if it is covering this block. In this example, the block is partially covered.

The parameters window automatically updates itself with parameters from the new block. In this case, they are all blank.

- Enter something for the comment field - 'Pump 2 Failed', for example, and a value of 2 for the digital input number. Click 'Apply' once more.
- Leaving the parameters window open, click on the digital output block, and enter a comment field 'Pump Alarm' for example, and a digital output number of 1.
- Click OK to apply the parameters and close the window.

The schematic should now look similar to this.

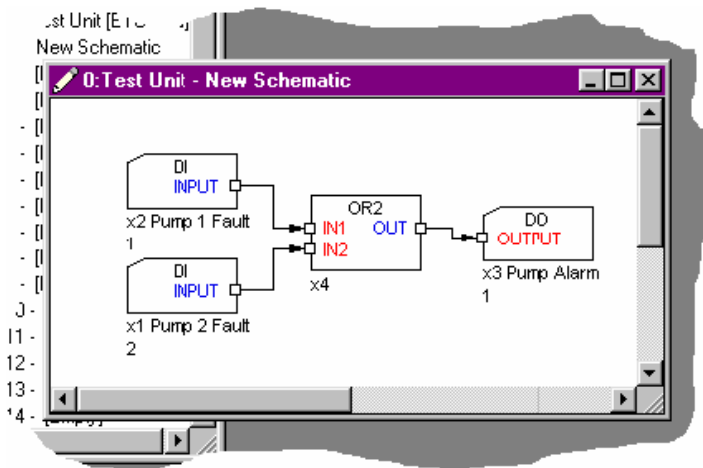

Note that the parameters are listed by the function block in the order that they appear in the parameters window. The look can be a bit unusual but is vital for documentation and debugging purposes.

1.3.6. Checking your schematic- text compiling

With your schematic page active, choose 'Project' - 'Test compile schematic' from the menu. This will perform a 'test compile' of your page. The result will tell you if everything's okay, or if you've not entered a parameter or if there is some other problem with your schematic.

Hopefully, all is ok. If not check the block concerned. The error message will tell you the block x-number of any erroneous blocks.

Checking your schematic - IO Usage

While your schematic may compile ok, you may wish to check a few more things. For example you may have used the same output twice, or the same input for multiple unrelated items.

For additional information see [The IO usage window](#) (when actually working in Abacus).

1.3.7. Linking and uploading your program

In order to upload the program to the Fireye PPC6000 or NX6100 control, Fireye's Comfire 2 version 2.0 or above must be running on your PC. For a complete description of Comfire 2 capabilities refer to Fireye bulletin NEX-1502.

- Before uploading, it may be a good idea to save the project file. Click  on the top toolbar, or choose 'File' - 'Save project' from the menu.

- If Fireeye Comfire 2 is not already running on your system, start it up. You can do this from the



menu. You'll find it under programs - Comfire 2.

After Comfire 2 starts, it should see the units connected to it - if it has been connected. Click the 'Scan Units' button. The unit address should be the same as that used for your program.

- Switching back to abacus, ensure that the schematic page is open and selected (click within the schematic), and choose 'Project' - 'Make program (Link schematics)' from the menu.

Abacus will now open all the schematic pages in your project that contain programs for the same unit as the current schematic page (one in this case).

When the compile / link process has finished - almost immediately in this case, this message will appear telling you how much memory (see [Program size limits](#)) has been used. Click 'Yes' to send the program to the control, or 'No' if this was just a 'dry run'.

NOTE: THE CONTROL MUST BE IN FULL COMMISSION MODE TO ACCEPT PROGRAM UPLOAD.

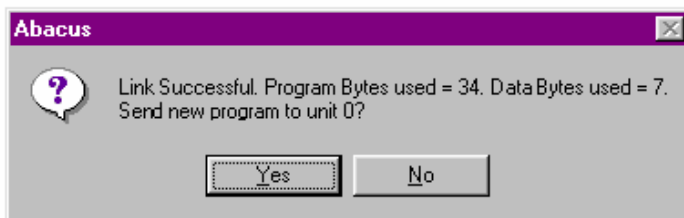

If the download completes with no errors, your program is now installed the control as the 'user program'. There can only be one 'user program' installed in a control. When you upload your program, you will overwrite any existing user program. See [Choosing the Running Program](#) to make your new program the active program (i.e. to run it).

1.4. The schematic toolbar

The function block toolbar can be used whenever a schematic page is open and active. If you are unsure what a button does, hold the mouse pointer over it and wait for the tip to come up as shown here.

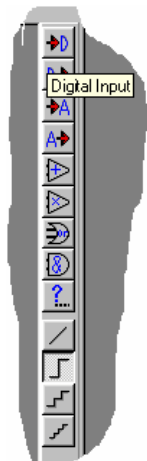

The top section of buttons will place selected function blocks on your schematic. The actual buttons shown may vary from those shown here, but the idea is the same.

This button  is the 'other block' button. This will open up a dialog window allowing you to select any function block from the database. See [Place Function blocks](#).

These 'line' buttons are used when editing the positions of the lines that link the blocks on the screen. The next link to be drawn will be in the style selected here. Also, you can use these to change the style of a currently selected link.

1.5. Place Function blocks

When the  button is clicked on the schematic toolbar, this window will open.

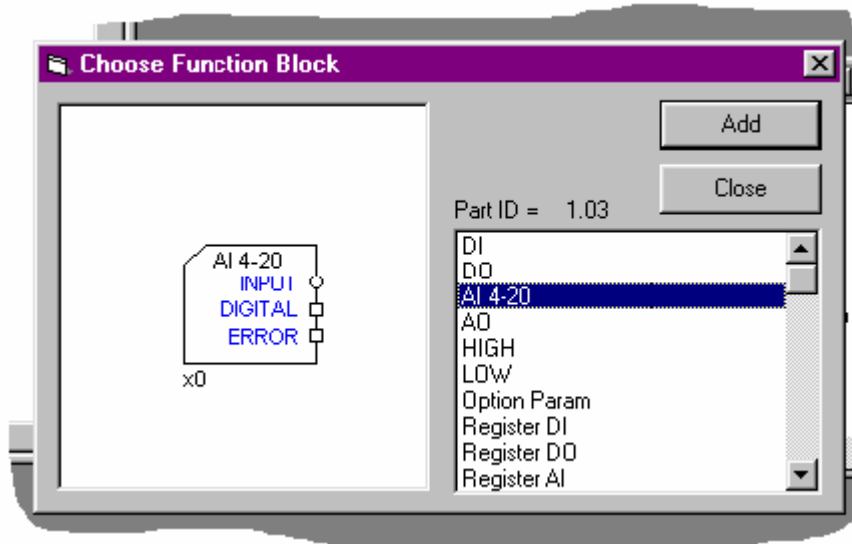

By clicking in the list you can preview all available function blocks. Click 'Add' to add the currently shown block to your schematic. To get help on the currently selected block, press F1.

1.6. Moving and editing the link lines

You can click on a link to select it. It will turn pink, and handles will appear on the corners of that link like this.

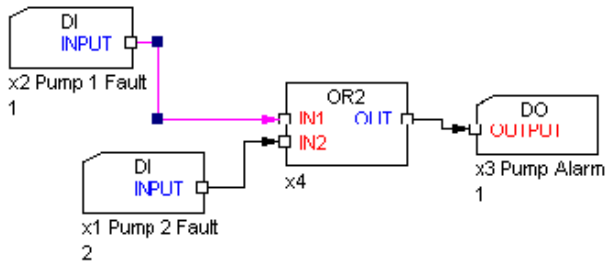

You can drag these handles to move the middle section of the link.

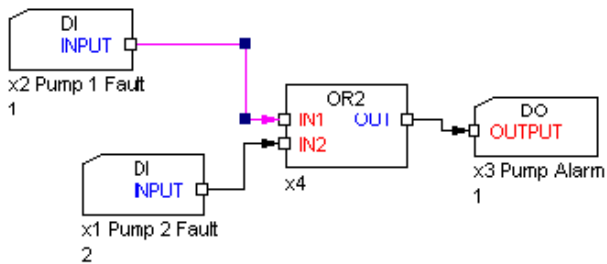

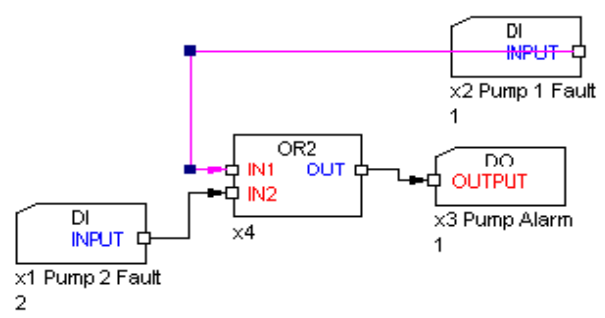

In this case, block x2 has been moved to the right, and now the link goes backwards through the block itself. There is nothing wrong, the program is the same, however, the appearance is unclear.

If you grab and drag the line handles in this case, you will not be able to improve the appearance.

It is here that you need to use the line style buttons on the schematic toolbar.

- With the link selected (i.e. pink), click the  button on the schematic tool bar. The schematic will change to the following:

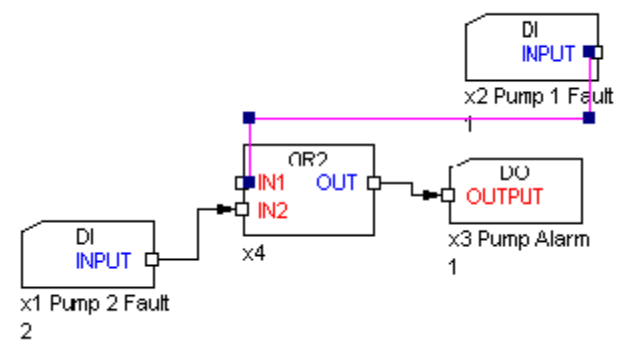

While not much clearer, you now have more handles to drag and can make the schematic look sensible once more.

The finished article may look like this:

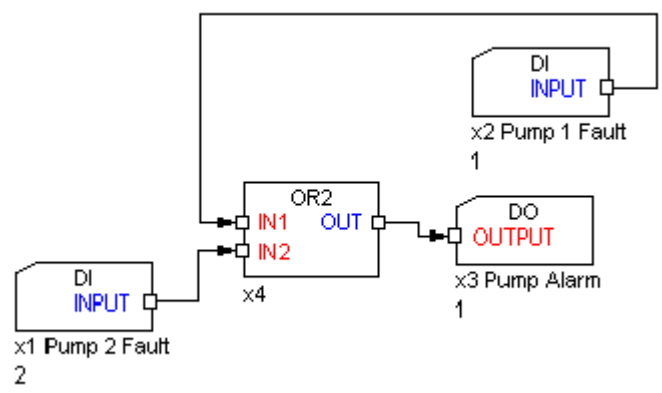

11 Circuit board connections

11.1 Inlet Air Temperature Sensor (Optional)

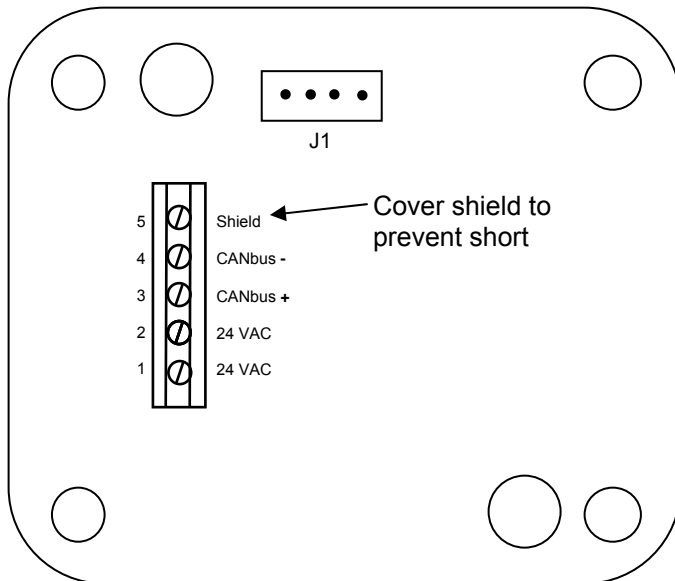

NOTE: Insulate Shield (Terminal 5) to prevent accidental shorting to pins on circuit board (J1)

NXIATS
Inlet Air Temperature Sensor

11.2 PPC6000 Variable Speed Drive Daughter Board P/N NXDBVSD

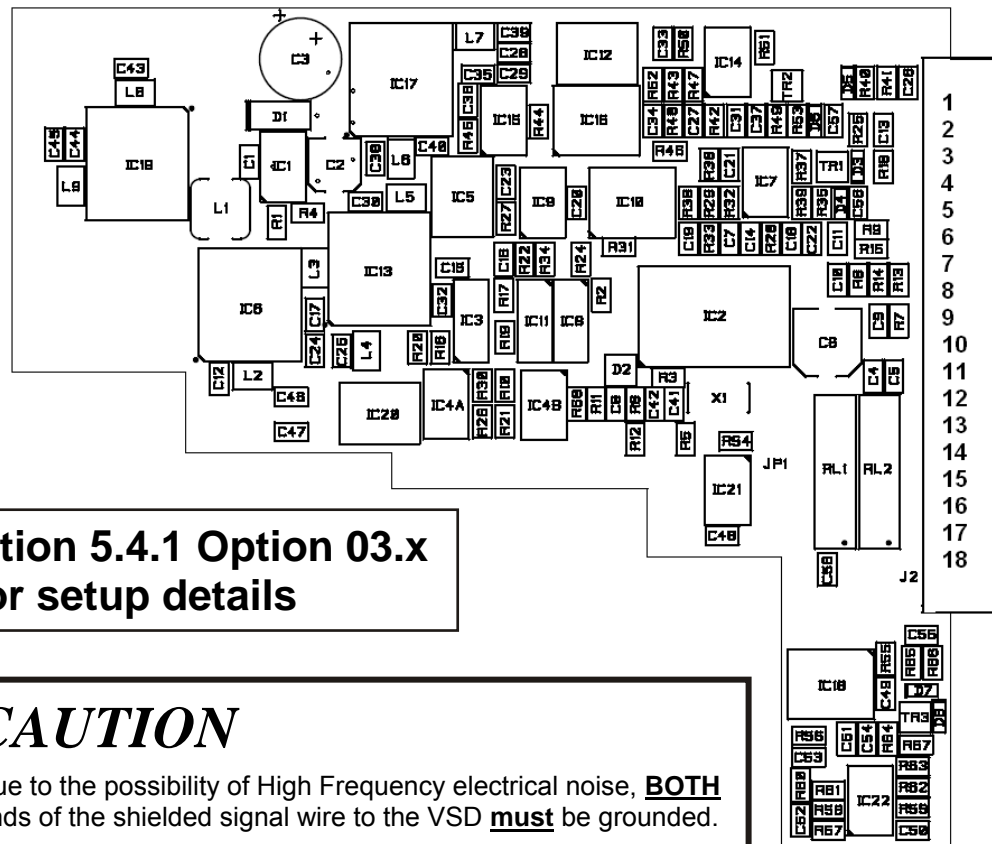

**See Section 5.4.1 Option 03.x
for setup details**

CAUTION

Due to the possibility of High Frequency electrical noise, **BOTH** ends of the shielded signal wire to the VSD **must** be grounded.

- | | |
|---------------------------|-------|
| 4-20mA Output Channel 1 - | PZ 1 |
| 4-20mA Output Channel 1 + | PZ 2 |
| 4-20mA Output Channel 2 - | PZ 3 |
| 4-20mA Output Channel 2 + | PZ 4 |
| 4-20mA Output Channel 3 - | PZ 5 |
| 4-20mA Output Channel 3 + | PZ 6 |
| Counter Input 1 | PZ 7 |
| +12Vdc | PZ 8 |
| Counter Input 2 | PZ 9 |
| +12Vdc | PZ 10 |
| Counter Input 3 | PZ 11 |
| Input Channel 1 - | PZ 12 |
| Input Channel 1 ± | PZ 13 |
| Input Channel 2 + | PZ 14 |
| Relay 7 common | PZ 15 |
| Relay 7 normally open | PZ 16 |
| Relay 8 common | PZ 17 |
| Relay 8 normally open | PZ 18 |

The cabling for all of these terminals must be 2-conductor (core) overall screened PVC insulated 24 AWG (7/0.2mm). Since this cable may be run in conduit with high voltage wiring, its voltage rating must exceed the maximum voltage carried by any other cable connected to the control or run in the same conduit.

The counter inputs are for use with encoder(s) for speed feedback from the devices being controller by the inverter(s) connected to the 4-20mA output(s) on this daughter board.

The analog outputs are isolated but the analog inputs are not and therefore special precautions must be taken when using these inputs.

The inputs are for 4-20mA signals **must** be isolated as the second input connects 'on-top' of the first to ensure 'cross-talks' will be detected. Terminal PX13 alternates ± to be shared with PZ12 and PZ14. This "switching" detects a direct link between input 1 and input 2 which is not allowed.

The function of relay 1 & 2 can be set by option parameter, but please note the maximum rating of these relays is 200mA at 50V.

Incorrect connection may damage or destroy the units being connected.

11.3 Oxygen probe connection (optional Oxygen Probe Interface unit)

Bussman S504 series
 PN GMA-5
 5 AMP (Fast Acting)
 (to protects transformer primary DC circuit)
 Alternate Source:
 Mouser Electronics : PN 504-GMA-5

PM 9 - PROBE HEATER >24VAC
 PM 8 - PROBE HEATER >24VAC
 PM 7 - FLUE TEMP. THERMOCOUPLE +
 PM 6 - FLUE TEMP. THERMOCOUPLE -
 PM 5 - CELL TEMP. +
 PM 4 - CELL TEMP. -
 PM 3 - CELL OUTPUT +
 PM 2 - CELL OUTPUT -

Bussmann - S504 series
 P/N GMD-630 (TIME Delay) for 115V
 P/N GMD-315 (TIME Delay) for 230V
 (to protect 24V circuit)
 Alternate Source::
 Mouser Electronics

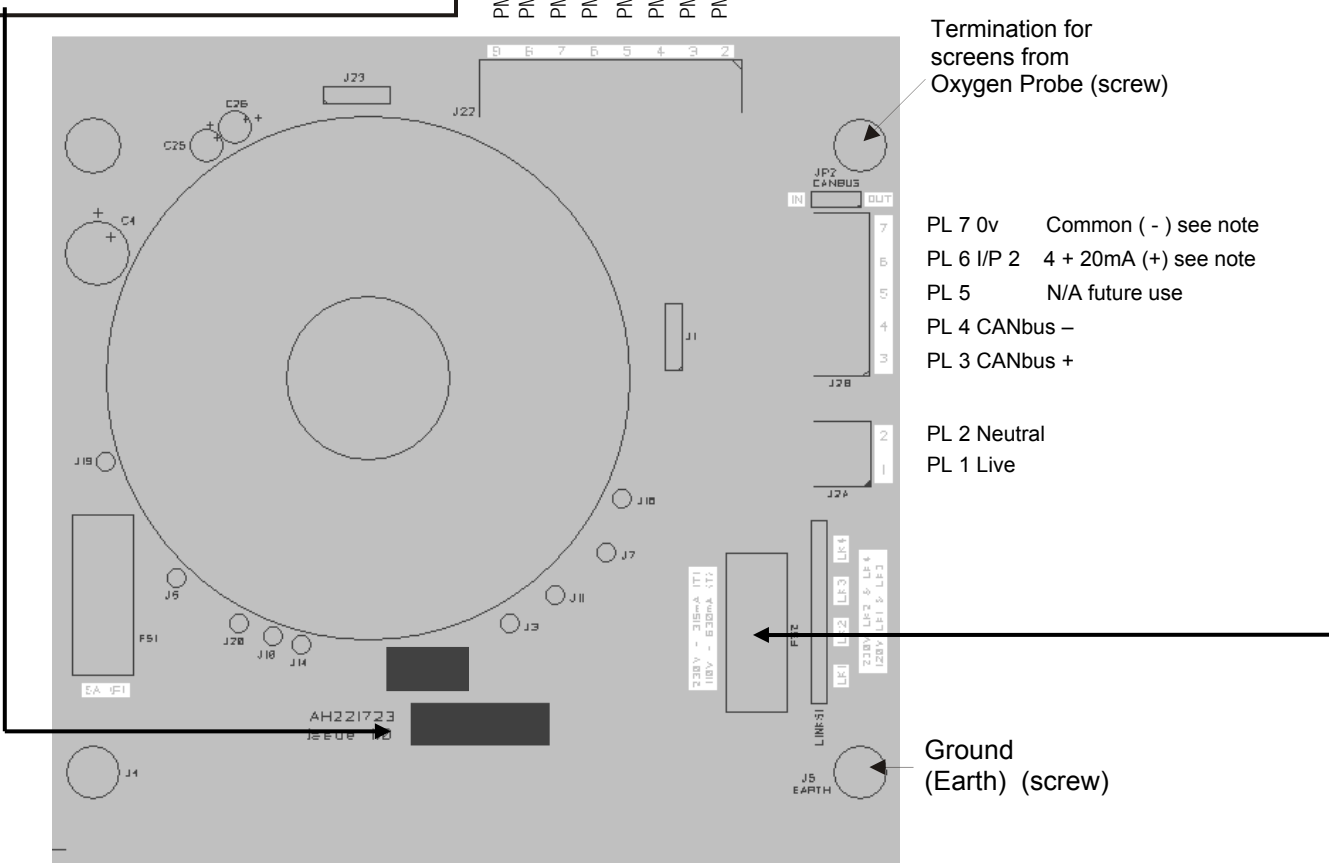

NOTE: 4-20mA O₂ input from non-Fireye O₂ probe. See sections 30.1 and 30.2

NX02INT

11.4 PPC6000

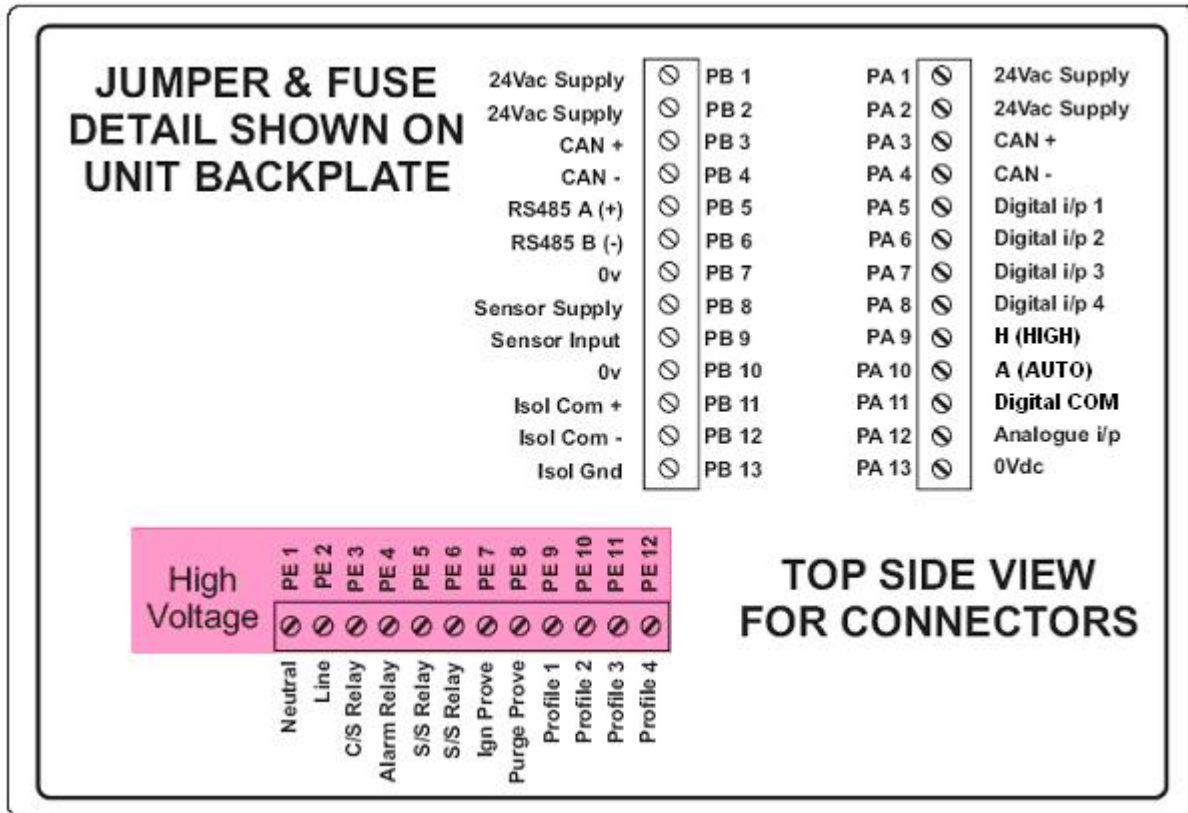



This manual may be downloaded from the Fireeye web site at: www.Fireeye.com
Click on “Bulletins” or search by bulletin number.

NOTICE

When Fireeye products are combined with equipment manufactured by other and/or integrated into systems designed or manufactured by others, the Fireeye warranty, as stated in its General Terms and Conditions of Sale, pertains only to the Fireeye products and not to any other equipment or to the combined system or its overall performance.

WARRANTIES

FIREYE guarantees for *one year from the date of installation or 18 months from date of manufacture* of its products to replace, or, at its option, to repair any product or part thereof (except lamps and photocells) which is found defective in material or workmanship or which otherwise fails to conform to the description of the product on the face of its sales order. **THE FOREGOING IS IN LIEU OF ALL OTHER WARRANTIES AND FIREYE MAKES NO WARRANTY OF MERCHANTABILITY OR ANY OTHER WARRANTY, EXPRESS OR IMPLIED.** Except as specifically stated in these general terms and conditions of sale, remedies with respect to any product or part number manufactured or sold by Fireeye shall be limited exclusively to the right to replacement or repair as above provided. In no event shall Fireeye be liable for consequential or special damages of any nature that may arise in connection with such product or part.



FIREYE
3 Manchester Road
Derry, New Hampshire 03038 USA
www.fireeye.com

PPC-6001
JANUARY 18, 2016
Supersedes October 7, 2015